



## 4066

## CMOS IC

### QUAD BILATERAL SWITCH

#### DESCRIPTION

The UTC **4066** is a quad bilateral switch intended for the transmission or multiplexing of analog or digital signals.

#### FEATURES

- \* Wide supply voltage range: 3V ~ 15V.
- \* High noise immunity : 0.45V<sub>DD</sub> (typ.)
- \* Wide range of digital and ± 7.5V<sub>PEAK</sub> analog switching
- \* "ON" resistance for 15V operation : 80Ω
- \* Matched "ON" resistance : ΔR<sub>ON</sub>=5Ω (typ.) over 15V signal input
- \* "ON" resistance flat over peak-to-peak signal range
- \* High "ON" / "OFF" : 65 dB (typ.)
- output voltage ratio @ f<sub>IS</sub>=10kHz, R<sub>L</sub>=10kΩ
- \* High degree linearity: 0.1% distortion (typ.) @ f<sub>IS</sub>=1kHz, V<sub>IS</sub>=5Vp-p, V<sub>DD</sub>-V<sub>SS</sub>=10V, R<sub>L</sub>=10kΩ
- \* Extremely low "OFF" : 0.1nA (typ.)
- \* switch leakage @V<sub>DD</sub>-V<sub>SS</sub>=10V, T<sub>A</sub>=25°C
- \* Extremely high control input impedance : 10<sup>12</sup>Ω (typ.)
- \* Low crosstalk : -50dB (typ.)
- \* between switches @ f<sub>IS</sub>=0.9MHz, R<sub>L</sub>=1kΩ
- \* Frequency response, switch "ON" : 40MHz (typ.)

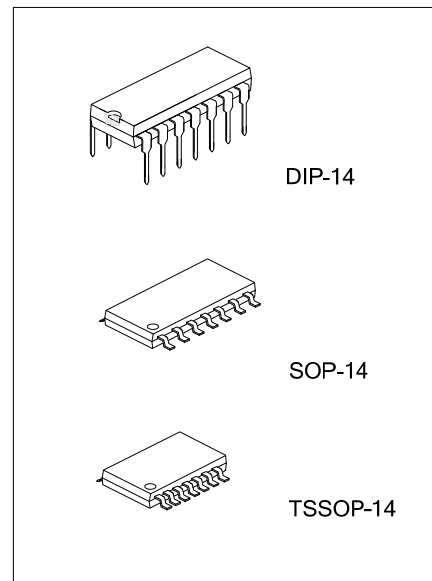

#### ORDERING INFORMATION

Ordering Number		Package	Packing
Lead Free	Halogen Free		
4066L-D14-T	4066G-D14-T	DIP-14	Tube
4066L-S14-R	4066G-S14-R	SOP-14	Tape Reel
4066L-P14-R	4066G-P14-R	TSSOP-14	Tape Reel

<p>4066G-D14-T</p> <p>(1)Packing Type (2)Package Type (3)Green Package</p>	<p>(1) R: Tape Reel, T: Tube (2) D14: DIP-14, P14: TSSOP-14, S14: SOP-14 (3) G: Halogen Free and Lead Free, L: Lead Free</p>
--	--

#### MARKING

DIP-14	SOP-14 / TSSOP-14
<p>Date Code L: Lead Free G: Halogen Free Lot Code</p>	<p>Date Code L: Lead Free G: Halogen Free Lot Code</p>

■ PIN CONFIGURATION

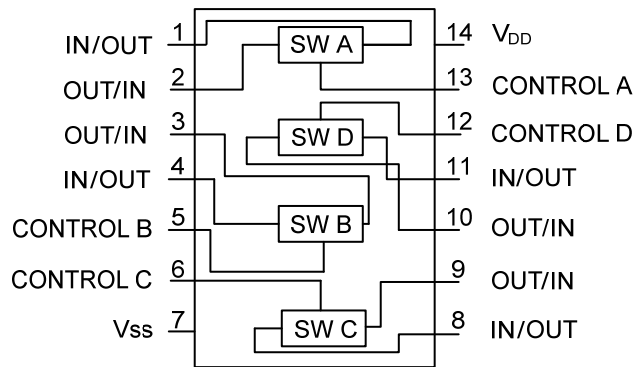

■ SCHEMATIC DIAGRAM

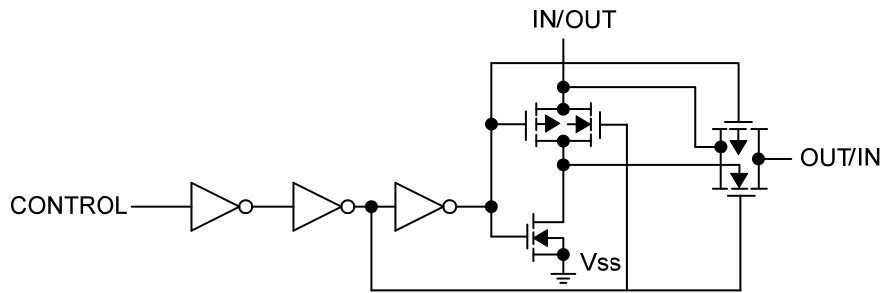

■ ABSOLUTE MAXIMUM RATINGS ( $V_{SS}=0V$ , unless otherwise specified)

PARAMETER		SYMBOL	RATINGS	UNIT
Supply Voltage		$V_{DD}$	-0.5 ~ +18	V
Input Voltage		$V_{IN}$	-0.5 ~ $V_{CC}+0.5$	V
Power Dissipation	DIP-14	$P_D$	700	mW
	SOP-14/TSSOP-14		500	
Junction Temperature		$T_J$	+125	°C
Storage Temperature		$T_{STG}$	-40 ~ +150	°C

Note: Absolute maximum ratings are those values beyond which the device could be permanently damaged. Absolute maximum ratings are stress ratings only and functional device operation is not implied.

■ RECOMMENDED OPERATING CONDITIONS ( $V_{SS}=0V$ , unless otherwise specified)

PARAMETER		SYMBOL	RATINGS	UNIT
Supply Voltage		$V_{DD}$	3 ~ 15	V
Input Voltage		$V_{IN}$	0 ~ $V_{DD}$	V
Operating Temperature Range		$T_{OPR}$	-40 ~ +85	°C

■ DC ELECTRICAL CHARACTERISTICS ( $V_{SS}=0V$ , unless otherwise specified)

PARAMETER	SYMBOL	CONDITIONS	MIN	TYP	MAX	UNIT
Quiescent Device Current	$I_{DD}$	$V_{DD}=5V$		0.01	1.0	$\mu A$
		$V_{DD}=10V$		0.01	2.0	
		$V_{DD}=15V$		0.01	4.0	
<b>SIGNAL INPUTS AND OUTPUTS</b>						
Input or Output Leakage Switch "OFF"	$I_{IS}$	$V_C=0$		$\pm 0.1$	$\pm 50$	nA
"ON" Resistance	$R_{ON}$	$R_L=10k\Omega \sim (V_{DD}-V_{SS}/2)$ $V_C=V_{DD}, V_{SS} \sim V_{DD}$	$V_{DD}=5V$	270	1050	$\Omega$
			$V_{DD}=10V$	120	400	
			$V_{DD}=15V$	80	240	
$\Delta$ "ON" Resistance Between Any 2 of 4 Switches	$\Delta R_{ON}$	$R_L=10k\Omega \sim (V_{DD}-V_{SS}/2)$ $V_C=V_{DD}, V_{IS}=V_{SS} \sim V_{DD}$	$V_{DD}=5V$	20		$\Omega$
			$V_{DD}=10V$	10		
			$V_{DD}=15V$	5		
<b>CONTROL INPUTS</b>						
Low Level Input Voltage	$V_{ILC}$	$V_{IS}=V_{SS}$ and $V_{DD}$ $V_{OS}=V_{DD}$ and $V_{SS}$ $I_{IS}=\pm 10\mu A$	$V_{DD}=5V$	2.25	1.5	V
			$V_{DD}=10V$	4.5	3.0	
			$V_{DD}=15V$	6.75	4.0	
HIGH Level Input Voltage	$V_{IHC}$	$V_{DD}=5V$ $V_{DD}=10V$ (Note) $V_{DD}=15V$	3.5	2.75		V
			7.0	5.5		
			11.0	8.25		
Input Current	$I_{IN}$	$V_{DD}-V_{SS}=15V, V_{DD} \geq V_{IS} \geq V_{SS},$ $V_{DD} \geq V_C \geq V_{SS}$		$\pm 10^{-5}$	$\pm 0.3$	$\mu A$

Note: Conditions for  $V_{IHC}$ : (a)  $V_{IS}=V_{DD}$ ,  $I_{OS}$ =standard B series  $I_{OH}$ . (b)  $V_{IS}=0V$ ,  $I_{OL}$ =standard B series  $I_{OL}$

■ AC ELECTRICAL CHARACTERISTICS (AC Parameters are guaranteed by DC correlated testing)

( $T_A=25^\circ\text{C}$ ,  $t_R=t_F=20\text{ ns}$  and  $V_{SS}=0\text{V}$  unless otherwise)

PARAMETER	SYMBOL	CONDITIONS	MIN	TYP	MAX	UNIT
Propagation Delay Time Signal Input to Signal Output	$T_{PHL}, T_{PLH}$	$V_C=V_{DD}, C_L=50\text{pF}$ (Figure 1) $R_L=200\text{k}$	$V_{DD}=5\text{V}$	25	55	ns
			$V_{DD}=10\text{V}$	15	35	
			$V_{DD}=15\text{V}$	10	25	
Propagation Delay Time Control Input to Signal Output High Impedance to Logical Level	$t_{PZH}, t_{PLZ}$	$R_L=1.0\text{k}\Omega, C_L=50\text{pF}$ (Fig. 2, 3)	$V_{DD}=5\text{V}$		125	ns
			$V_{DD}=10\text{V}$		60	
			$V_{DD}=15\text{V}$		50	
Propagation Delay Time Control Input to Signal Output Logical Level to High Impedance		$R_L=1.0\text{k}\Omega, C_L=50\text{pF}$ (Fig. 2, 3)	$V_{DD}=5\text{V}$		125	ns
			$V_{DD}=10\text{V}$		60	
			$V_{DD}=15\text{V}$		50	
Sine Wave Distortion	$t_{PHZ}, t_{PLZ}$	$V_C=V_{DD}=5\text{V}, V_{SS}=-5\text{V}$ $R_L=10\text{k}\Omega, V_{IS}=5\text{V}_{P-P}, f=1\text{kHz}$ , (Fig. 4)		0.1		%
Frequency Response -Switch "ON" (Frequency at -3dB)				40		MHz
Feedthrough - Switch "OFF" (Frequency at -50 dB)		$V_{DD}=5.0\text{V}, V_{CC}=V_{SS}=-5.0\text{V}, R_L=1\text{k}\Omega,$ $V_{IS}=5.0\text{V}_{P-P}, 20\text{Log}_{10}, V_{OS}/V_{IS}=-50\text{dB}$ , (Fig. 4)		1.25		MHz
Crosstalk Between Any Two Switches(Frequency at -50dB)		$V_{DD}=V_C(A)=5.0\text{V}; V_{SS}=V_C(B)=5.0\text{V},$ $R_L=1\text{k}\Omega, V_{IS}(A)=5.0\text{V}_{P-P}, 20\text{Log}_{10},$ $V_{OS}(B)/V_{IS}(A)=-50\text{dB}$ (Fig. 5)		0.9		MHz
Crosstalk; Control Input to Signal Output		$V_{DD}=10\text{V}, R_L=10\text{k}\Omega, R_{IN}=1.0\text{k}\Omega,$ $V_{CC}=10\text{V}$ Square Wave, $C_L=50\text{pF}$ (Fig. 6)		150		$\text{mV}_{p-p}$
Maximum Control Input		$R_L=1.0\text{k}\Omega, C_L=50\text{pF}$ (Fig. 7) $V_{OS}(f)=1/2V_{OS}(1.0\text{kHz})$	$V_{DD}=5.0\text{V}$	6.0		MHz
			$V_{DD}=10\text{V}$	8.0		
			$V_{DD}=15\text{V}$	8.5		
Signal Input Capacitance	$C_{IS}$			8.0		pF
Signal Output Capacitance	$C_{OS}$	$V_{DD}=10\text{V}$		8.0		pF
Feedthrough Capacitance	$C_{IOS}$	$V_C=0\text{V}$		0.5		pF
Control Input Capacitance	$C_{IN}$			5.0	7.5	pF

■ SPECIAL CONSIDERATIONS

In applications where separate power sources are used to drive  $V_{DD}$  and the signal input, the  $V_{DD}$  current capability should exceed  $V_{DD}/R_L$  ( $R_L$ =effective external load of the UTC 4066 bilateral switches).This provision avoids any permanent current flow or clamp action of the  $V_{DD}$  supply when power is applied or removed from UTC 4066.

In certain applications, the external load-resistor current may include both  $V_{DD}$  and Signal-line components. To avoid drawing  $V_{DD}$  current when switch current flows into terminals 1,4,8 or 11,the voltage drop across the bidirectional swith must not exceed 0.6V at  $T_A \leq 25^\circ\text{C}$ , or 0.4V at  $T_A > 25^\circ\text{C}$  (calculated from  $R_{ON}$  values shown).

NO  $V_{DD}$  current will flow through  $R_L$  if the switch current flows into terminals 2, 3, 9 or 10.

■ AC TEST CIRCUITS AND SWITCHING TIME WAVEFORMS

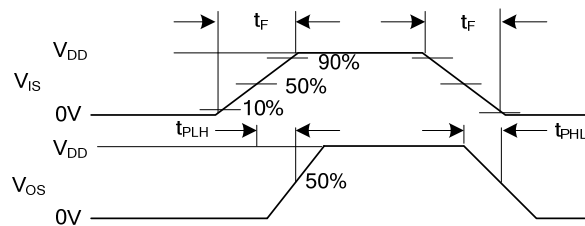
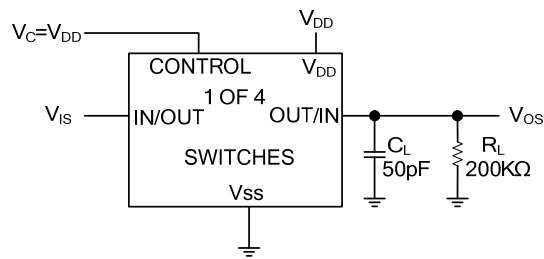

Fig.1  $t_{PHL}$ ,  $t_{PLH}$  Propagation Delay Time Signal Input to Signal Output

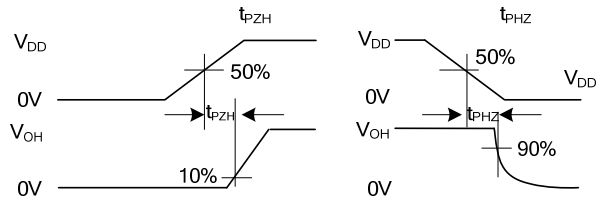
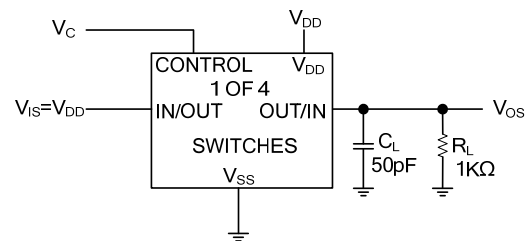

Fig. 2  $t_{PZH}$ ,  $t_{PHZ}$  Propagation Delay Time Control to Signal Output

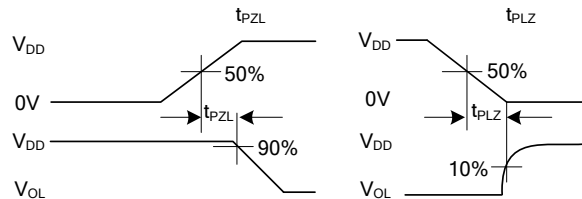
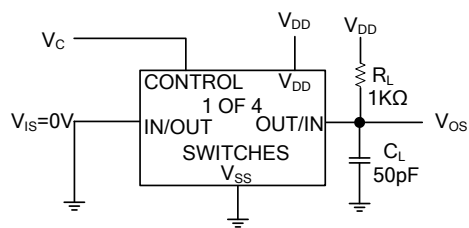
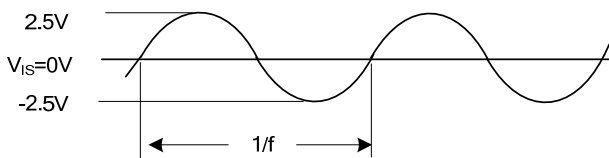
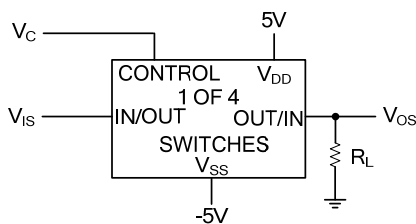

Fig. 3  $t_{PZL}$ ,  $t_{PLZ}$  Propagation Delay Time Control to Signal Output



$V_C=V_{DD}$  for distortion and frequency response tests  
 $V_C=V_{SS}$  for feedthrough test

Fig. 4 Sine Wave Distortion, Frequency Response and Feedthrough

■ AC TEST CIRCUITS AND SWITCHING TIME WAVEFORMS(Cont.)

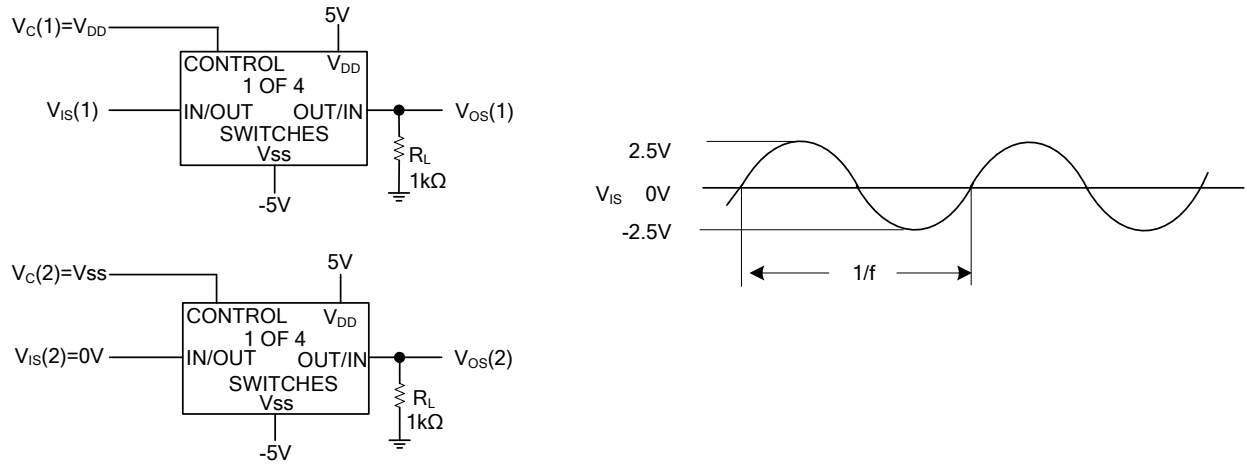

Fig. 5 Crosstalk Between Any Two Switches

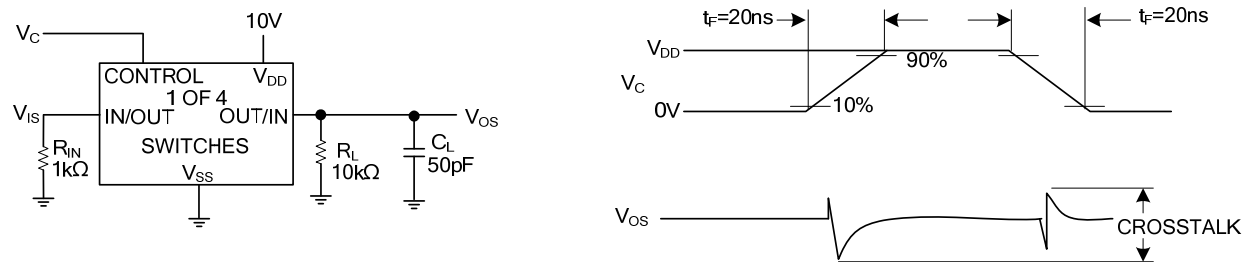

Fig.6 Crosstalk: Control Input to Signal Output

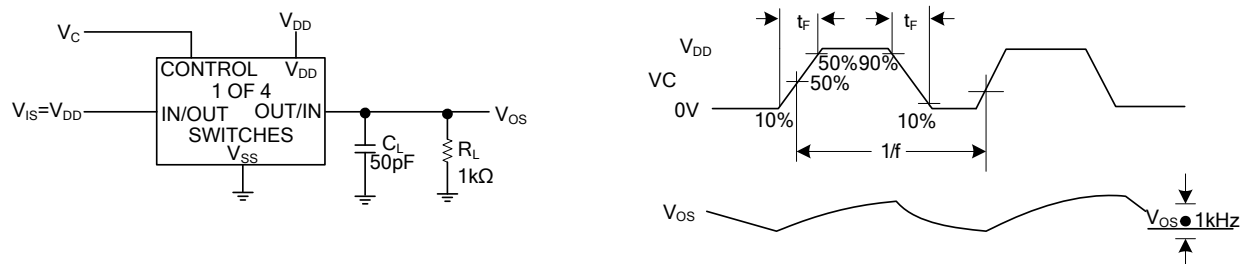
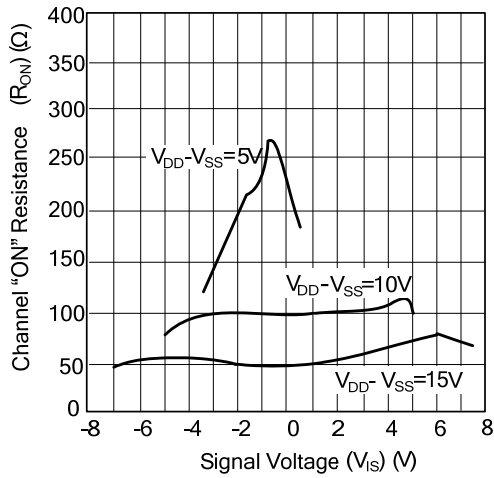

Fig. 7 Maximum Control Input Frequency

■ TYPICAL PERFORMANCE CHARACTERISTICS

“ON” Resistance vs Signal Voltage for  $T_A=25^\circ\text{C}$



“ON” Resistance as a Function of temperature for  $V_{DD}-V_{SS}=15\text{V}$

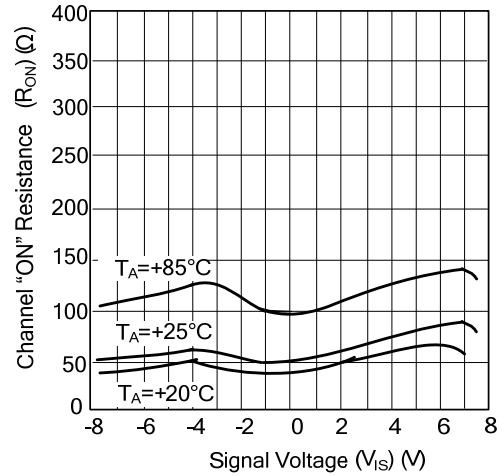

“ON” Resistance as a Function of Temperature for  $V_{DD}-V_{SS}=10\text{V}$

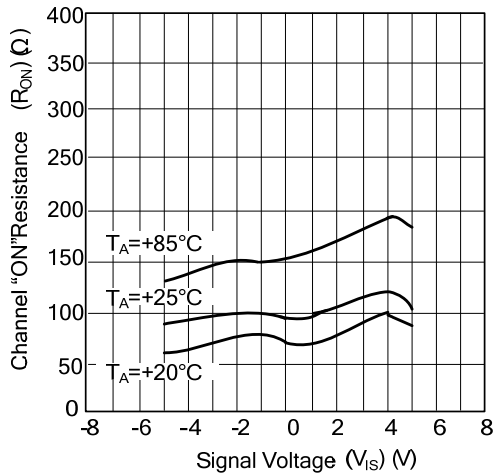

“ON” Resistance as a Function of Temperature for  $V_{DD}-V_{SS}=15\text{V}$

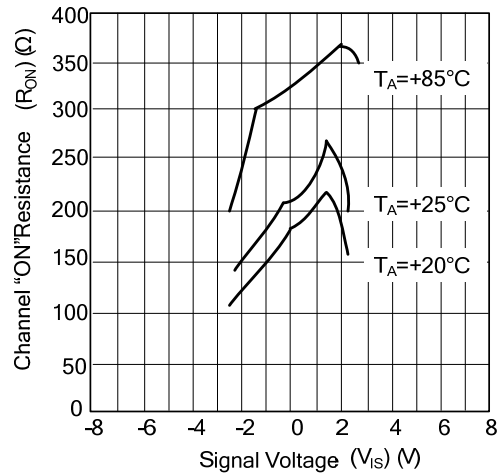

UTC assumes no responsibility for equipment failures that result from using products at values that exceed, even momentarily, rated values (such as maximum ratings, operating condition ranges, or other parameters) listed in products specifications of any and all UTC products described or contained herein. UTC products are not designed for use in life support appliances, devices or systems where malfunction of these products can be reasonably expected to result in personal injury. Reproduction in whole or in part is prohibited without the prior written consent of the copyright owner. The information presented in this document does not form part of any quotation or contract, is believed to be accurate and reliable and may be changed without notice.