



**78MXX**

**LINEAR INTEGRATED CIRCUIT**

**3-TERMINAL 0.5A POSITIVE VOLTAGE REGULATOR**

■ **DESCRIPTION**

The UTC **78MXX** family is monolithic fixed voltage regulator integrated circuit. They are suitable for applications that required supply current up to 0.5A.

■ **FEATURES**

- \* Output Current up to 0.5A
- \* Fixed Output Voltage of 5V, 6V, 7V, 8V, 9V, 12V, 15V, 18V and 20V Available
- \* Thermal Overload Shutdown Protection
- \* Short Circuit Current Limiting
- \* Output Transistor SOA Protection

■ **ORDERING INFORMATION**

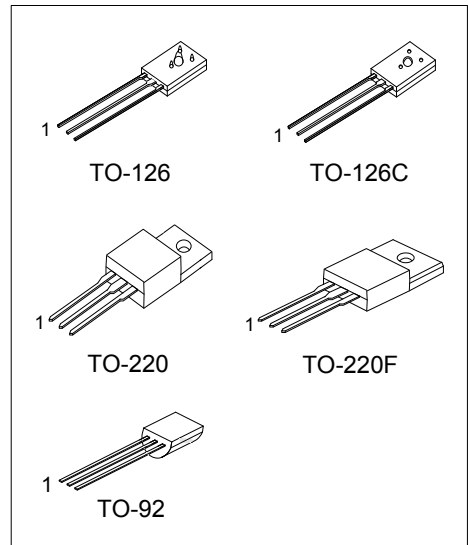

Ordering Number		Package	Pin Assignment			Packing
Lead Free	Halogen Free		1	2	3	
78MXXL-TA3-T	78MXXG-TA3-T	TO-220	I	G	O	Tube
78MXXL-TF3-T	78MXXG-TF3-T	TO-220F	I	G	O	Tube
78MXXL-T60-K	78MXXG-T60-K	TO-126	I	G	O	Bulk
78MXXL-T6C-K	78MXXG-T6C-K	TO-126C	I	G	O	Bulk
78MXXL-T92-B	78MXXG-T92-B	TO-92	O	G	I	Tape Box
78MXXL-T92-K	78MXXG-T92-K	TO-92	O	G	I	Bulk

<p>78MXXL-TA3-T</p>	<p>(1) T: Tube, B: Tape Box, K: Bulk                  (2) TA3: TO-220, TF3: TO-220F, T60: TO-126                  T6C: TO-126C, T92: TO-92                  (3) L: Lead Free, G: Halogen Free and Lead Free                  (4) xx: refer to Marking Information</p>
---------------------	---

### MARKING INFORMATION

PACKAGE	VOLTAGE CODE	MARKING
TO-220 TO-220F	05: 5V 06: 6V 07: 7V 08: 8V 09: 9V 12: 12V 15: 15V 18: 18V 20: 20V	<p>UTC 78MXX</p> <p>Voltage Code ←      → L: Lead Free                      Lot Code ←      → G: Halogen Free                      Date Code</p> <p>1 2 3</p>
TO-126 TO-126C		<p>UTC 78MXX</p> <p>Voltage Code ←      → Date Code                      → L: Lead Free                      → G: Halogen Free</p> <p>1 2 3</p>
TO-92		<p>UTC 78MXX</p> <p>Voltage Code ←      → L: Lead Free                      → G: Halogen Free                      → Date Code</p> <p>1 2 3</p>

### BLOCK DIAGRAM

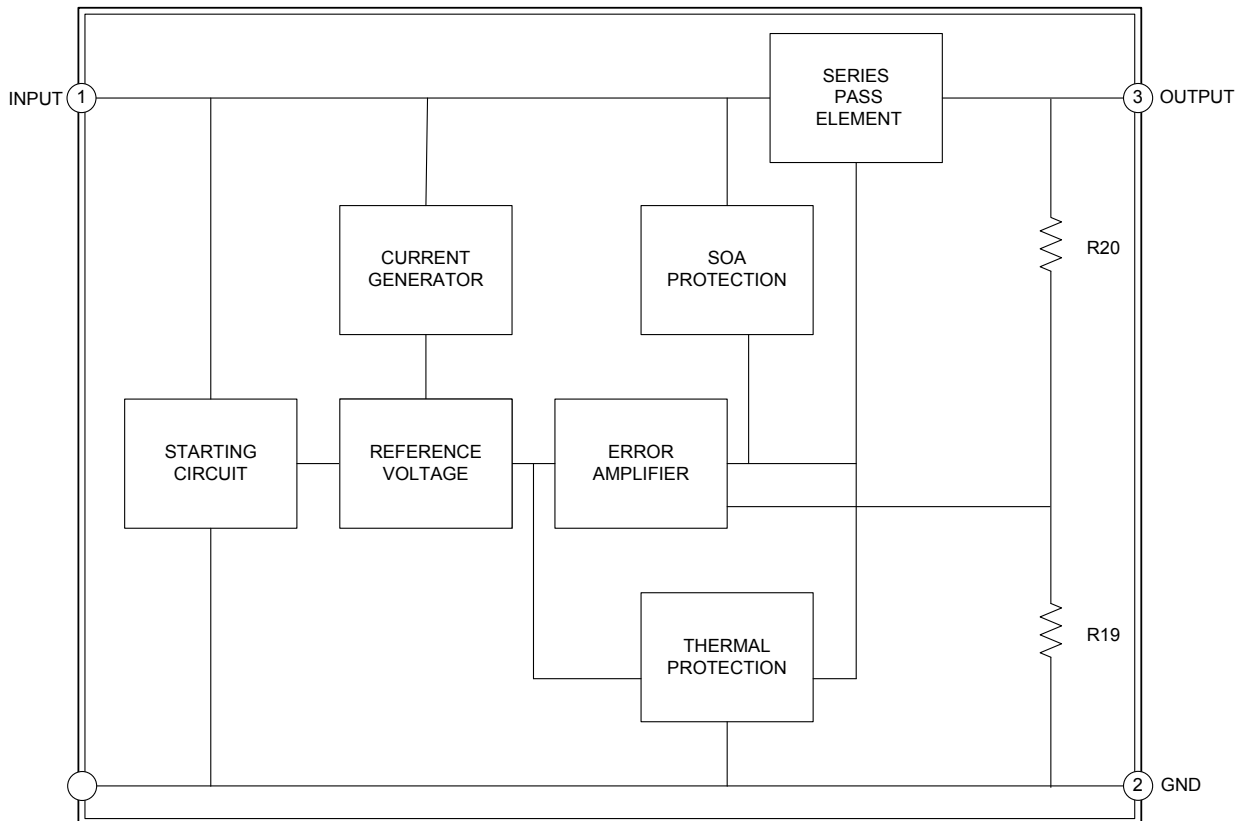

### ■ ABSOLUTE MAXIMUM RATINGS

(Operating temperature range applies unless otherwise specified)

PARAMETER	SYMBOL	RATING	UNIT
Input Voltage	$V_{IN}$	35	V
Output Current	$I_{OUT}$	0.5	A
Power Dissipation	$P_D$	Internally Limited	W
Operating Junction Temperature	$T_{OPR}$	-40 ~ +85	°C
Storage Temperature	$T_{STG}$	-65 ~ +150	°C

Note: Absolute maximum ratings are those values beyond which the device could be permanently damaged.

Absolute maximum ratings are stress ratings only and functional device operation is not implied.

### ■ ELECTRICAL CHARACTERISTICS

#### FOR UTC78M05

(Refer to the test circuits,  $T_J=25^\circ\text{C}$ ,  $I_{OUT}=350\text{mA}$ ,  $V_{IN}=10\text{V}$ , unless otherwise specified,  $C_I=0.33\mu\text{F}$ ,  $C_O=0.1\mu\text{F}$ )

PARAMETER	SYMBOL	TEST CONDITIONS	MIN	TYP	MAX	UNIT
Output Voltage	$V_{OUT}$	$T_J=25^\circ\text{C}$	4.80	5.0	5.20	V
		$I_{OUT}=5\text{mA} \sim 350\text{mA}$ , $V_{IN}=7 \sim 20\text{V}$	4.75		5.25	V
Load Regulation	$\Delta V_{OUT}$	$T_J=25^\circ\text{C}$ , $I_{OUT}=5\text{mA} \sim 0.5\text{A}$			100	mV
		$T_J=25^\circ\text{C}$ , $I_{OUT}=5\text{mA} \sim 200\text{mA}$			50	mV
Line regulation	$\Delta V_{OUT}$	$V_{IN}=7 \sim 25\text{V}$ , $T_J=25^\circ\text{C}$ , $I_{OUT}=200\text{mA}$			100	mV
		$V_{IN}=8 \sim 25\text{V}$ , $T_J=25^\circ\text{C}$ , $I_{OUT}=200\text{mA}$			50	mV
Quiescent Current	$I_Q$	$T_J=25^\circ\text{C}$		4.0	6.0	mA
Quiescent Current Change	$\Delta I_Q$	$V_{IN}=8 \sim 25\text{V}$ , $I_{OUT}=200\text{mA}$			0.8	mA
		$I_{OUT}=5\text{mA} \sim 350\text{mA}$			0.5	mA
Output Noise Voltage	eN	$10\text{Hz} \leq f \leq 100\text{KHz}$		40		$\mu\text{V}$
Ripple Rejection	RR	$V_{IN}=8 \sim 18\text{V}$ , $f=120\text{Hz}$ , $I_{OUT}=300\text{mA}$	62			dB
Peak Output Current	$I_{PEAK}$	$T_J=25^\circ\text{C}$		700		mA
Short-Circuit Current	$I_{SC}$	$V_{IN}=V_{OUT}+19\text{V}$ , $T_J=25^\circ\text{C}$		300		mA
Dropout Voltage	$V_D$	$T_J=25^\circ\text{C}$ , $I_{OUT}=500\text{mA}$		2.0		V

#### FOR UTC78M06

(Refer to the test circuits,  $T_J=25^\circ\text{C}$ ,  $I_{OUT}=350\text{mA}$ ,  $V_{IN}=11\text{V}$ , unless otherwise specified,  $C_I=0.33\mu\text{F}$ ,  $C_O=0.1\mu\text{F}$ )

PARAMETER	SYMBOL	TEST CONDITIONS	MIN	TYP	MAX	UNIT
Output Voltage	$V_{OUT}$	$T_J=25^\circ\text{C}$ , $I_{OUT}=5 \sim 350\text{mA}$	5.76	6.0	6.24	V
		$V_{IN}=8 \sim 21\text{V}$ , $I_{OUT}=5\text{mA} \sim 350\text{mA}$	5.70		6.30	V
Load Regulation	$\Delta V_{OUT}$	$T_J=25^\circ\text{C}$ , $I_{OUT}=5\text{mA} \sim 0.5\text{A}$			120	mV
		$T_J=25^\circ\text{C}$ , $I_{OUT}=5\text{mA} \sim 200\text{mA}$			60	mV
Line regulation	$\Delta V_{OUT}$	$V_{IN}=8\text{V} \sim 25\text{V}$ , $T_J=25^\circ\text{C}$ , $I_{OUT}=200\text{mA}$			100	mV
		$V_{IN}=9\text{V} \sim 25\text{V}$ , $T_J=25^\circ\text{C}$ , $I_{OUT}=200\text{mA}$			50	mV
Quiescent Current	$I_Q$	$T_J=25^\circ\text{C}$		4.0	6	mA
Quiescent Current Change	$\Delta I_Q$	$I_{OUT}=5\text{mA} \sim 350\text{mA}$			0.8	mA
		$V_{IN}=9\text{V} \sim 25\text{V}$ , $I_{OUT}=200\text{mA}$			0.5	mA
Output Noise Voltage	eN	$10\text{Hz} \leq f \leq 100\text{KHz}$		45		$\mu\text{V}$
Ripple Rejection	RR	$V_{IN}=9\text{V} \sim 19\text{V}$ , $f=120\text{Hz}$ , $T_J=25^\circ\text{C}$ $I_{OUT}=300\text{mA}$	59			dB
Peak Output Current	$I_{PEAK}$	$T_J=25^\circ\text{C}$		700		mA
Short-Circuit Current	$I_{SC}$	$V_{IN}=V_{OUT}+19\text{V}$ , $T_J=25^\circ\text{C}$		300		mA
Dropout Voltage	$V_D$	$T_J=25^\circ\text{C}$		2.0		V

■ ELECTRICAL CHARACTERISTICS (Cont.)

**FOR UTC78M07**

(Refer to the test circuits,  $T_J=25^\circ\text{C}$ ,  $I_{OUT}=350\text{mA}$ ,  $V_{IN}=13\text{V}$ , unless otherwise specified,  $C_I=0.33\mu\text{F}$ ,  $C_O=0.1\mu\text{F}$ )

PARAMETER	SYMBOL	TEST CONDITIONS	MIN	TYP	MAX	UNIT
Output Voltage	$V_{OUT}$	$T_J=25^\circ\text{C}$	6.72	7.0	7.28	V
		$V_{IN}=9.5\text{V} \sim 22\text{V}$ , $I_{OUT}=5\text{mA} \sim 350\text{mA}$	6.65		7.35	V
Load Regulation	$\Delta V_{OUT}$	$T_J=25^\circ\text{C}$ , $I_{OUT}=5\text{mA} \sim 0.5\text{A}$			140	mV
		$T_J=25^\circ\text{C}$ , $I_{OUT}=5\text{mA} \sim 200\text{mA}$			70	mV
Line regulation	$\Delta V_{OUT}$	$V_{IN}=9.5\text{V} \sim 22\text{V}$ , $T_J=25^\circ\text{C}$ , $I_{OUT}=200\text{mA}$			100	mV
		$V_{IN}=9.5\text{V} \sim 22\text{V}$ , $T_J=25^\circ\text{C}$ , $I_{OUT}=200\text{mA}$			50	mV
Quiescent Current	$I_Q$	$T_J=25^\circ\text{C}$		4.0	6	mA
Quiescent Current Change	$\Delta I_Q$	$V_{IN}=10.5\text{V} \sim 22\text{V}$ , $I_{OUT}=200\text{mA}$			0.8	mA
		$I_{OUT}=5\text{mA} \sim 350\text{mA}$			0.5	mA
Output Noise Voltage	eN	$10\text{Hz} \leq f \leq 100\text{KHz}$		49		$\mu\text{V}$
Ripple Rejection	RR	$V_{IN}=11.5\text{V} \sim 21.5\text{V}$ , $f=120\text{Hz}$ , $I_{OUT}=300\text{mA}$	57			dB
Peak Output Current	$I_{PEAK}$	$T_J=25^\circ\text{C}$		700		mA
Short-Circuit Current	$I_{SC}$	$V_{IN}=V_{OUT}+19\text{V}$ , $T_J=25^\circ\text{C}$		300		mA
Dropout Voltage	$V_D$	$T_J=25^\circ\text{C}$ , $I_{OUT}=500\text{mA}$		2.0		V

**FOR UTC78M08**

(Refer to the test circuits,  $T_J=25^\circ\text{C}$ ,  $I_{OUT}=350\text{mA}$ ,  $V_{IN}=14\text{V}$ , unless otherwise specified,  $C_I=0.33\mu\text{F}$ ,  $C_O=0.1\mu\text{F}$ )

PARAMETER	SYMBOL	TEST CONDITIONS	MIN	TYP	MAX	UNIT
Output Voltage	$V_{OUT}$	$T_J=25^\circ\text{C}$	7.68	8.0	8.32	V
		$V_{IN}=10.5\text{V} \sim 23\text{V}$ , $I_{OUT}=5\text{mA} \sim 350\text{mA}$	7.60		8.40	V
Load Regulation	$\Delta V_{OUT}$	$T_J=25^\circ\text{C}$ , $I_{OUT}=5\text{mA} \sim 0.5\text{A}$			160	mV
		$T_J=25^\circ\text{C}$ , $I_{OUT}=5\text{mA} \sim 200\text{mA}$			80	mV
Line regulation	$\Delta V_{OUT}$	$V_{IN}=10.5\text{V} \sim 25\text{V}$ , $T_J=25^\circ\text{C}$ , $I_{OUT}=200\text{mA}$			100	mV
		$V_{IN}=11\text{V} \sim 25\text{V}$ , $T_J=25^\circ\text{C}$ , $I_{OUT}=200\text{mA}$			50	mV
Quiescent Current	$I_Q$	$T_J=25^\circ\text{C}$		4.0	6	mA
Quiescent Current Change	$\Delta I_Q$	$V_{IN}=10.5\text{V} \sim 25\text{V}$ , $I_{OUT}=200\text{mA}$			0.8	mA
		$I_{OUT}=5\text{mA} \sim 350\text{mA}$			0.5	mA
Output Noise Voltage	eN	$10\text{Hz} \leq f \leq 100\text{KHz}$		52		$\mu\text{V}$
Ripple Rejection	RR	$V_{IN}=11.5\text{V} \sim 21.5\text{V}$ , $f=120\text{Hz}$ , $I_{OUT}=300\text{mA}$	56			dB
Peak Output Current	$I_{PEAK}$	$T_J=25^\circ\text{C}$		700		mA
Short-Circuit Current	$I_{SC}$	$V_{IN}=V_{OUT}+19\text{V}$ , $T_J=25^\circ\text{C}$		300		mA
Dropout Voltage	$V_D$	$T_J=25^\circ\text{C}$ , $I_{OUT}=500\text{mA}$		2.0		V

■ ELECTRICAL CHARACTERISTICS (Cont.)

**FOR UTC78M09**

(Refer to the test circuits,  $T_J=25^\circ\text{C}$ ,  $I_{OUT}=350\text{mA}$ ,  $V_{IN}=17\text{V}$ , unless otherwise specified,  $C_I=0.33\mu\text{F}$ ,  $C_O=0.1\mu\text{F}$ )

PARAMETER	SYMBOL	TEST CONDITIONS	MIN	TYP	MAX	UNIT
Output Voltage	$V_{OUT}$	$T_J=25^\circ\text{C}$	8.64	9	9.36	V
		$V_{IN}=12.5\text{V} \sim 25\text{V}$ , $I_{OUT}=5\text{mA} \sim 350\text{mA}$	8.55		9.45	V
Load Regulation	$\Delta V_{OUT}$	$T_J=25^\circ\text{C}$ , $I_{OUT}=5\text{mA} \sim 0.5\text{A}$			200	mV
		$T_J=25^\circ\text{C}$ , $I_{OUT}=5\text{mA} \sim 200\text{mA}$			100	mV
Line regulation	$\Delta V_{OUT}$	$V_{IN}=12.5\text{V} \sim 25\text{V}$ , $T_J=25^\circ\text{C}$ , $I_{OUT}=200\text{mA}$			100	mV
		$V_{IN}=13\text{V} \sim 25\text{V}$ , $T_J=25^\circ\text{C}$ , $I_{OUT}=200\text{mA}$			50	mV
Quiescent Current	$I_Q$	$T_J=25^\circ\text{C}$		4.1	6	mA
Quiescent Current Change	$\Delta I_Q$	$V_{IN}=12.5\text{V} \sim 25\text{V}$ , $I_{OUT}=200\text{mA}$			0.8	mA
		$I_{OUT}=5\text{mA} \sim 350\text{mA}$			0.5	mA
Output Noise Voltage	eN	$10\text{Hz} \leq f \leq 100\text{kHz}$		65		$\mu\text{V}$
Ripple Rejection	RR	$V_{IN}=13\text{V} \sim 23\text{V}$ , $f=120\text{Hz}$ , $I_{OUT}=300\text{mA}$	55			dB
Peak Output Current	$I_{PEAK}$	$T_J=25^\circ\text{C}$		700		mA
Short-Circuit Current	$I_{SC}$	$V_{IN}=V_{OUT}+19\text{V}$ , $T_J=25^\circ\text{C}$		300		mA
Dropout Voltage	$V_D$	$T_J=25^\circ\text{C}$ , $I_{OUT}=500\text{mA}$		2.0		V

**FOR UTC78M12**

(Refer to the test circuits,  $T_J=25^\circ\text{C}$ ,  $I_{OUT}=350\text{mA}$ ,  $V_{IN}=19\text{V}$ , unless otherwise specified,  $C_I=0.33\mu\text{F}$ ,  $C_O=0.1\mu\text{F}$ )

PARAMETER	SYMBOL	TEST CONDITIONS	MIN	TYP	MAX	UNIT
Output Voltage	$V_{OUT}$	$T_J=25^\circ\text{C}$	11.52	12.0	12.48	V
		$V_{IN}=14.5\text{V}$ to $27\text{V}$ , $I_{OUT}=5\text{mA} \sim 350\text{mA}$	11.40		12.60	V
Load Regulation	$\Delta V_{OUT}$	$T_J=25^\circ\text{C}$ , $I_{OUT}=5\text{mA} \sim 0.5\text{A}$			240	mV
		$T_J=25^\circ\text{C}$ , $I_{OUT}=5\text{mA} \sim 2\text{A}$			120	mV
Line regulation	$\Delta V_{OUT}$	$V_{IN}=14.5\text{V}$ to $30\text{V}$ , $T_J=25^\circ\text{C}$ , $I_{OUT}=200\text{mA}$			100	mV
		$V_{IN}=16\text{V}$ to $30\text{V}$ , $T_J=25^\circ\text{C}$ , $I_{OUT}=200\text{mA}$			50	mV
Quiescent Current	$I_Q$	$T_J=25^\circ\text{C}$		4.1	6.0	mA
Quiescent Current Change	$\Delta I_Q$	$V_{IN}=14.5\text{V}$ to $30\text{V}$ , $I_{OUT}=200\text{mA}$			0.8	mA
		$I_{OUT}=5\text{mA} \sim 350\text{mA}$			0.5	mA
Output Noise Voltage	eN	$10\text{Hz} \leq f \leq 100\text{kHz}$		75		$\mu\text{V}$
Ripple Rejection	RR	$V_{IN}=15\text{V}$ to $25\text{V}$ , $f=120\text{Hz}$ , $I_{OUT}=300\text{mA}$	55			dB
Peak Output Current	$I_{PEAK}$	$T_J=25^\circ\text{C}$		700		mA
Short-Circuit Current	$I_{SC}$	$V_{IN}=V_{OUT}+19\text{V}$ , $T_J=25^\circ\text{C}$		300		mA
Dropout Voltage	$V_D$	$T_J=25^\circ\text{C}$ , $I_{OUT}=500\text{mA}$		2.0		V

■ ELECTRICAL CHARACTERISTICS (Cont.)

**FOR UTC78M15**

(Refer to the test circuits,  $T_J=25^\circ\text{C}$ ,  $I_{OUT}=350\text{mA}$ ,  $V_{IN}=23\text{V}$ , unless otherwise specified,  $C_I=0.33\mu\text{F}$ ,  $C_O=0.1\mu\text{F}$ )

PARAMETER	SYMBOL	TEST CONDITIONS	MIN	TYP	MAX	UNIT
Output Voltage	$V_{OUT}$	$T_J=25^\circ\text{C}$	14.40	15.0	15.60	V
		$V_{IN}=17.5\text{V} \sim 30\text{V}$ , $I_{OUT}=5\text{mA} \sim 350\text{mA}$	14.25		15.75	V
Load Regulation	$\Delta V_{OUT}$	$T_J=25^\circ\text{C}$ , $I_{OUT}=5\text{mA} \sim 0.5\text{A}$			300	mV
		$T_J=25^\circ\text{C}$ , $I_{OUT}=5\text{mA} \sim 200\text{mA}$			150	mV
Line regulation	$\Delta V_{OUT}$	$V_{IN}=17.5\text{V} \sim 30\text{V}$ , $T_J=25^\circ\text{C}$ , $I_{OUT}=200\text{mA}$			100	mV
		$V_{IN}=20\text{V} \sim 30\text{V}$ , $T_J=25^\circ\text{C}$ , $I_{OUT}=200\text{mA}$			50	mV
Quiescent Current	$I_Q$	$T_J=25^\circ\text{C}$		4.1	6.0	mA
Quiescent Current Change	$\Delta I_Q$	$V_{IN}=17.5\text{V} \sim 30\text{V}$ , $I_{OUT}=200\text{mA}$			0.8	mA
		$I_{OUT}=5\text{mA} \sim 350\text{mA}$			0.5	mA
Output Noise Voltage	eN	$10\text{Hz} \leq f \leq 100\text{KHz}$		90		$\mu\text{V}$
Ripple Rejection	RR	$V_{IN}=18.5\text{V} \sim 28.5\text{V}$ , $f=120\text{Hz}$ , $I_{OUT}=300\text{mA}$	54			dB
Peak Output Current	$I_{PEAK}$	$T_J=25^\circ\text{C}$		700		mA
Short-Circuit Current	$I_{SC}$	$V_{IN}=V_{OUT}+19\text{V}$ , $T_J=25^\circ\text{C}$		300		mA
Dropout Voltage	$V_D$	$T_J=25^\circ\text{C}$ , $I_{OUT}=500\text{mA}$		2.0		V

**FOR 78M18**

(Refer to the test circuits,  $T_J=25^\circ\text{C}$ ,  $I_{OUT}=350\text{mA}$ ,  $V_{IN}=26\text{V}$ , unless otherwise specified,  $C_I=0.33\mu\text{F}$ ,  $C_O=0.1\mu\text{F}$ )

PARAMETER	SYMBOL	TEST CONDITIONS	MIN	TYP	MAX	UNIT
Output Voltage	$V_{OUT}$	$T_J=25^\circ\text{C}$	17.28	18.0	18.72	V
		$V_{IN}=20.5\text{V} \sim 33\text{V}$ , $I_{OUT}=5\text{mA} \sim 350\text{mA}$	17.10		18.90	V
Load Regulation	$\Delta V_{OUT}$	$T_J=25^\circ\text{C}$ , $I_{OUT}=5\text{mA} \sim 0.5\text{A}$			360	mV
		$T_J=25^\circ\text{C}$ , $I_{OUT}=5\text{mA} \sim 200\text{mA}$			180	mV
Line regulation	$\Delta V_{OUT}$	$V_{IN}=21\text{V} \sim 33\text{V}$ , $T_J=25^\circ\text{C}$ , $I_{OUT}=200\text{mA}$			100	mV
		$V_{IN}=24\text{V} \sim 33\text{V}$ , $T_J=25^\circ\text{C}$ , $I_{OUT}=200\text{mA}$			50	mV
Quiescent Current	$I_Q$	$T_J=25^\circ\text{C}$		4.2	6	mA
Quiescent Current Change	$\Delta I_Q$	$V_{IN}=21\text{V} \sim 33\text{V}$ , $I_{OUT}=200\text{mA}$			0.8	mA
		$I_{OUT}=5\text{mA} \sim 350\text{mA}$			0.5	mA
Output Noise Voltage	eN	$10\text{Hz} \leq f \leq 100\text{KHz}$		100		$\mu\text{V}$
Ripple Rejection	RR	$V_{IN}=22\text{V} \sim 32\text{V}$ , $f=120\text{Hz}$ , $I_{OUT}=300\text{mA}$	53			dB
Peak Output Current	$I_{PEAK}$	$T_J=25^\circ\text{C}$		700		mA
Short-Circuit Current	$I_{SC}$	$V_{IN}=35\text{V}$ , $T_J=25^\circ\text{C}$		300		mA
Dropout Voltage	$V_D$	$T_J=25^\circ\text{C}$		2.0		V

■ ELECTRICAL CHARACTERISTICS (Cont.)

FOR 78M20

(Refer to the test circuits,  $T_J=25^\circ\text{C}$ ,  $I_{OUT}=350\text{mA}$ ,  $V_{IN}=29\text{V}$ , unless otherwise specified,  $C_I=0.33\mu\text{F}$ ,  $C_O=0.1\mu\text{F}$ )

PARAMETER	SYMBOL	TEST CONDITIONS	MIN	TYP	MAX	UNIT
Output Voltage	$V_{OUT}$	$T_J=25^\circ\text{C}$	19.20	20.0	20.80	V
		$V_{IN}=23\text{V} \sim 35\text{V}$ $I_{OUT}=5\text{mA} \sim 350\text{mA}$	19		21	V
Load Regulation	$\Delta V_{OUT}$	$T_J=25^\circ\text{C}$ , $I_{OUT}=5\text{mA} \sim 0.5\text{A}$			400	mV
		$T_J=25^\circ\text{C}$ , $I_{OUT}=5\text{mA} \sim 200\text{mA}$			200	mV
Line regulation	$\Delta V_{OUT}$	$V_{IN}=23\text{V} \sim 35\text{V}$ $T_J=25^\circ\text{C}$ , $I_{OUT}=200\text{mA}$			100	mV
		$V_{IN}=24\text{V} \sim 35\text{V}$ , $T_J=25^\circ\text{C}$ , $I_{OUT}=200\text{mA}$			50	mV
Quiescent Current	$I_Q$	$T_J=25^\circ\text{C}$		4	6	mA
Quiescent Current Change	$\Delta I_Q$	$V_{IN}=23.5\text{V} \sim 35\text{V}$ , $I_{OUT}=200\text{mA}$			0.8	mA
		$I_{OUT}=5\text{mA} \sim 350\text{mA}$			0.5	mA
Output Noise Voltage	eN	10HzM $\leq$ f $\leq$ 100KHz		105		$\mu\text{V}$
Ripple Rejection	RR	$V_{IN}=24\text{V} \sim 34\text{V}$ , f=120Hz $I_{OUT}=300\text{mA}$	52			dB
Peak Output Current	$I_{PEAK}$	$T_J=25^\circ\text{C}$		700		mA
Short-Circuit Current	$I_{SC}$	$V_{IN}=35\text{V}$ , $T_J=25^\circ\text{C}$		300		mA
Dropout Voltage	$V_D$	$T_J=25^\circ\text{C}$		2.0		V

Notes: 1. The Maximum steady state usable output current is dependent on input voltage, heat sinking, lead length of the package and copper pattern of PCB. The data above represents pulse test conditions with junction temperatures specified at the initiation of test.

2. Power dissipation < 0.5W

### ■ APPLICATION CIRCUIT

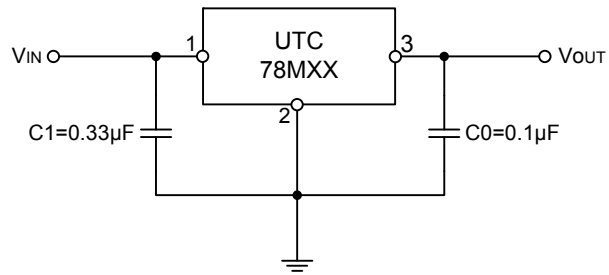

- Notes:
1. To specify an output voltage, substitute voltage value for "MXX".
  2. Bypass capacitors are recommended for optimum stability and transient response and should be located as close as possible to the regulators.



## TYPICAL CHARACTERISTICS

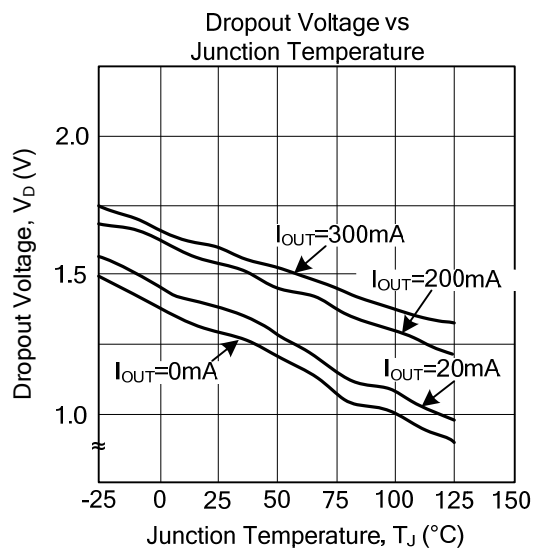
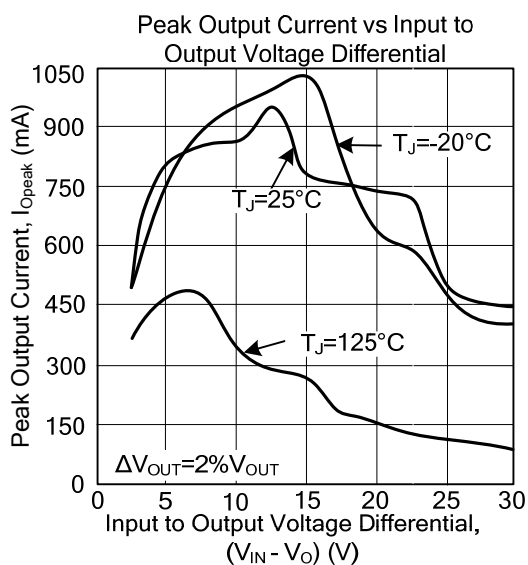
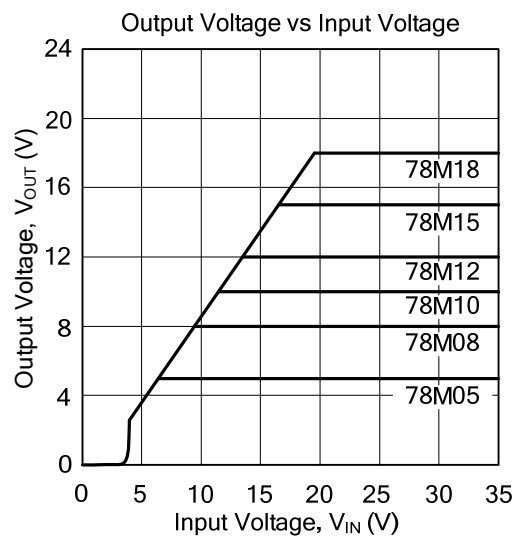
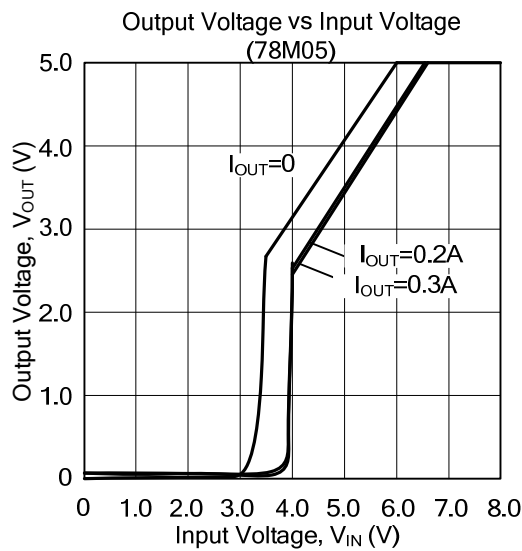
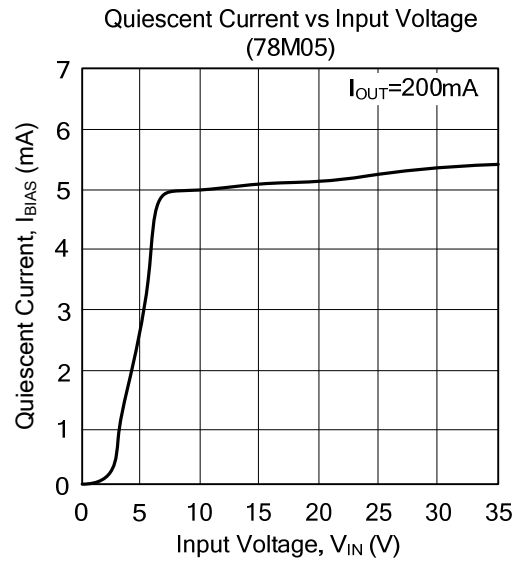
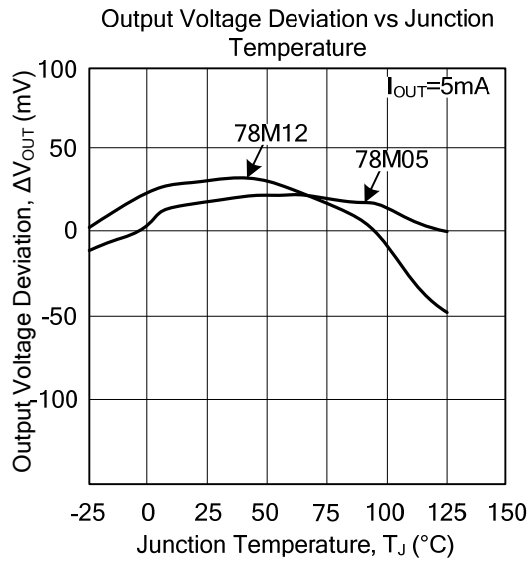

■ TYPICAL CHARACTERISTICS(Cont.)

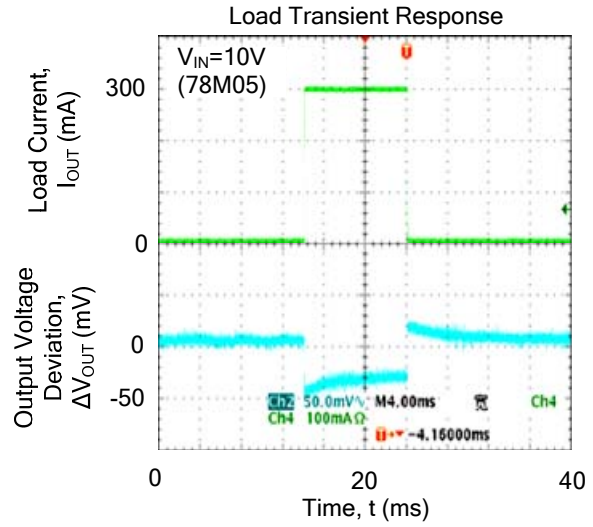
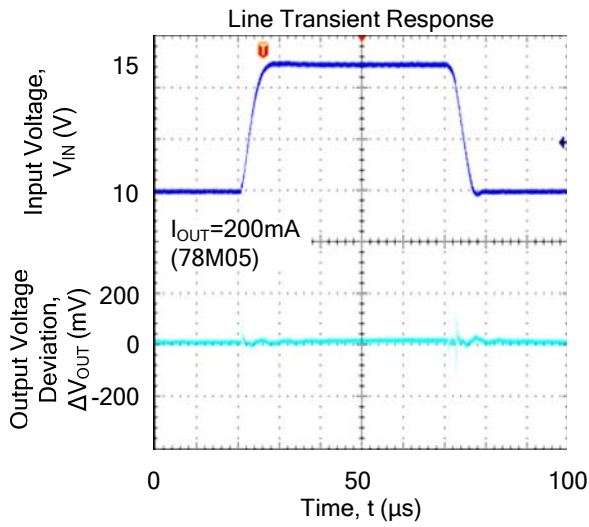

UTC assumes no responsibility for equipment failures that result from using products at values that exceed, even momentarily, rated values (such as maximum ratings, operating condition ranges, or other parameters) listed in products specifications of any and all UTC products described or contained herein. UTC products are not designed for use in life support appliances, devices or systems where malfunction of these products can be reasonably expected to result in personal injury. Reproduction in whole or in part is prohibited without the prior written consent of the copyright owner. The information presented in this document does not form part of any quotation or contract, is believed to be accurate and reliable and may be changed without notice.