



B772SS

PNP SILICON TRANSISTOR

MEDIUM POWER LOW VOLTAGE TRANSISTOR

DESCRIPTION

The UTC **B772SS** is a medium power low voltage transistor, designed for audio power amplifier, DC-DC converter and voltage regulator.

FEATURES

- * High current output up to 3A
- * Low saturation voltage
- * Complement to D882SS

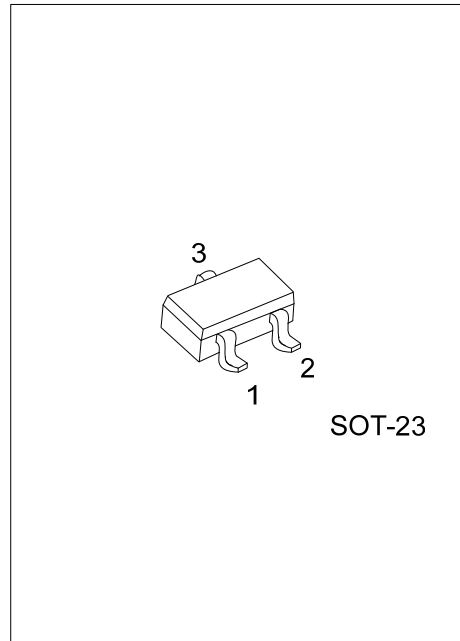

ORDERING INFORMATION

Order Number		Package	Pin Assignment			Packing
Lead Free	Halogen Free		1	2	3	
B772SSL-x-AE3-R	B772SSG-x-AE3-R	SOT-23	B	E	C	Tape Reel

Note: Pin Assignment: B: Base E: Emitter C: Collector

<p>B772SSG-x-AE3-R</p>	<p>(1) R: Tape Reel</p> <p>(2) AE3: SOT-23</p> <p>(3) x: refer to Classification of h_{FE2}</p> <p>(4) G: Halogen Free and Lead Free, L: Lead Free</p>
------------------------	---

MARKING

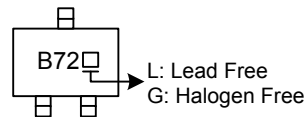

■ ABSOLUTE MAXIMUM RATINGS ($T_A = 25^\circ\text{C}$)

PARAMETER		SYMBOL	RATINGS	UNIT
Collector-Base Voltage		V_{CBO}	-40	V
Collector-Emitter Voltage		V_{CEO}	-30	V
Emitter-Base Voltage		V_{EBO}	-5	V
Collector Current	Pulse	I_{CP}	-7	A
	DC	I_C	-3	A
Base Current		I_B	-0.6	A
Collector Dissipation	$T_C=25^\circ\text{C}$	P_D	10	W
	$T_A=25^\circ\text{C}$		350	mW
Junction Temperature		T_J	+150	$^\circ\text{C}$
Storage Temperature		T_{STG}	-55 ~ +150	$^\circ\text{C}$

Note: Absolute maximum ratings are those values beyond which the device could be permanently damaged. Absolute maximum ratings are stress ratings only and functional device operation is not implied.

■ THERMAL DATA

PARAMETER	SYMBOL	RATINGS	UNIT
Junction to Ambient	θ_{JA}	357	$^\circ\text{C/W}$
Junction to Case	θ_{JC}	104	$^\circ\text{C/W}$

■ ELECTRICAL CHARACTERISTICS ($T_A = 25^\circ\text{C}$, unless otherwise specified)

PARAMETER	SYMBOL	TEST CONDITIONS	MIN	TYP	MAX	UNIT
Collector-Base Breakdown Voltage	BV_{CBO}	$I_C = -100\mu\text{A}, I_E = 0$	-40			V
Collector-Emitter Breakdown Voltage	BV_{CEO}	$I_C = -1\text{mA}, I_B = 0$	-30			V
Emitter-Base Breakdown Voltage	BV_{EBO}	$I_E = -100\mu\text{A}, I_C = 0$	-5			V
Collector Cut-Off Current	I_{CBO}	$V_{CB} = -30\text{V}, I_E = 0$			-1000	nA
Collector Cut-Off Current	I_{CEO}	$V_{CE} = -30\text{V}, I_B = 0$			-1000	nA
Emitter Cut-Off Current	I_{EBO}	$V_{EB} = -3\text{V}, I_C = 0$			-1000	nA
DC Current Gain(Note)	h_{FE1}	$V_{CE} = -2\text{V}, I_C = -20\text{mA}$	30	200		
	h_{FE2}	$V_{CE} = -2\text{V}, I_C = -1\text{A}$	100	150	400	
Collector-Emitter Saturation Voltage	$V_{CE(SAT)}$	$I_C = -2\text{A}, I_B = -0.2\text{A}$		-0.3	-0.5	V
Base-Emitter Saturation Voltage	$V_{BE(SAT)}$	$I_C = -2\text{A}, I_B = -0.2\text{A}$		-1.0	-2.0	V
Current Gain Bandwidth Product	f_T	$V_{CE} = -5\text{V}, I_C = -0.1\text{A}$		80		MHz
Output Capacitance	C_{ob}	$V_{CB} = -10\text{V}, I_E = 0, f = 1\text{MHz}$		45		pF

Note: Pulse test: $P_W < 300\mu\text{s}$, Duty Cycle $< 2\%$

■ CLASSIFICATION OF h_{FE2}

RANK	Q	P	E
RANGE	100 ~ 200	160 ~ 320	200 ~ 400

TYPICAL CHARACTERISTICS

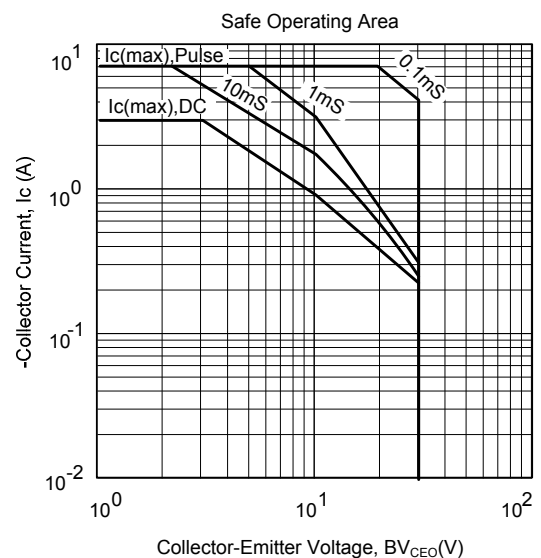
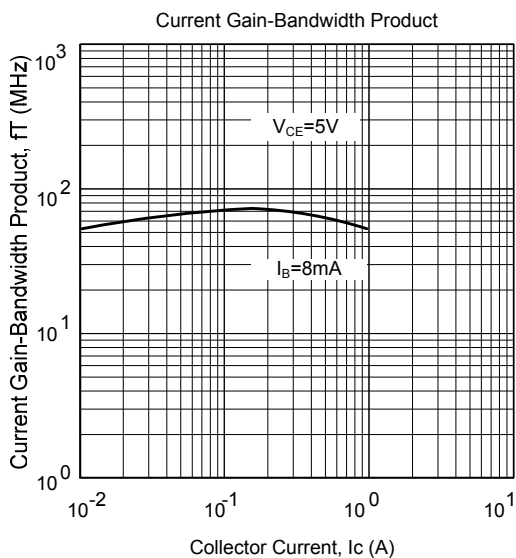
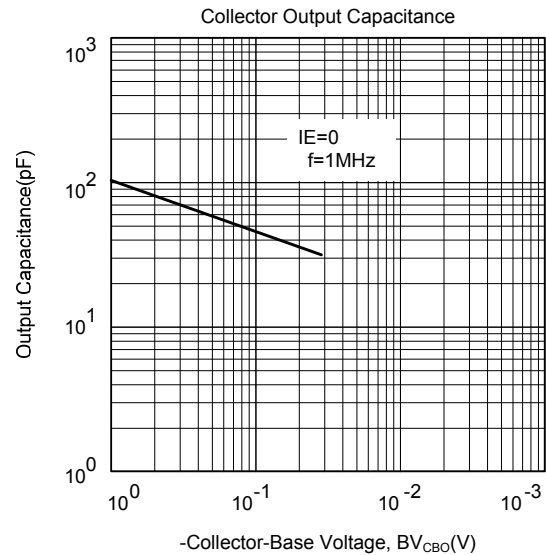
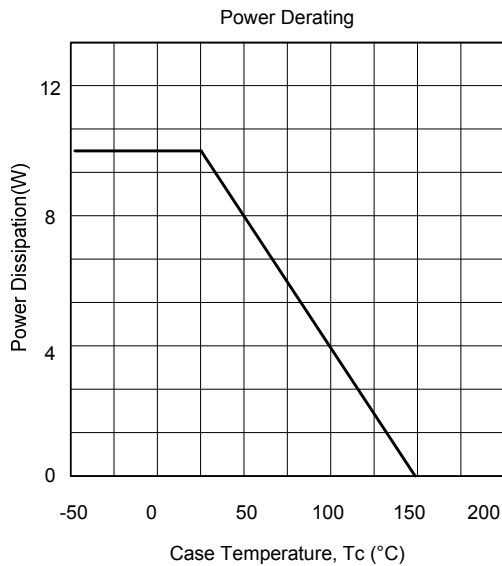
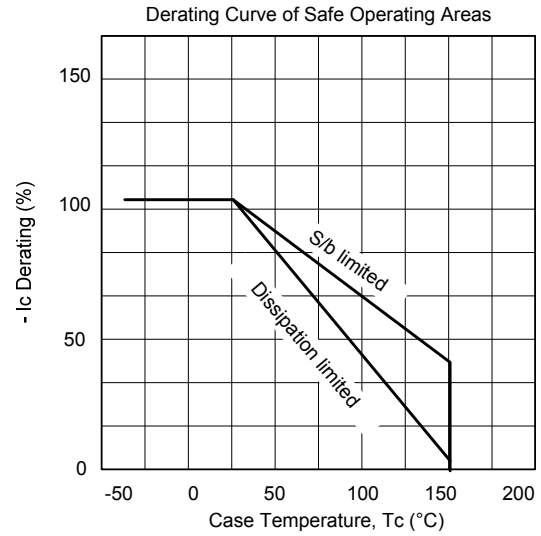
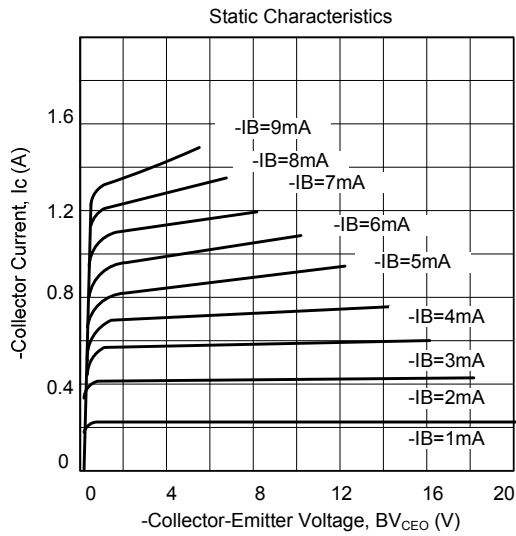

■ TYPICAL CHARACTERISTICS(Cont.)

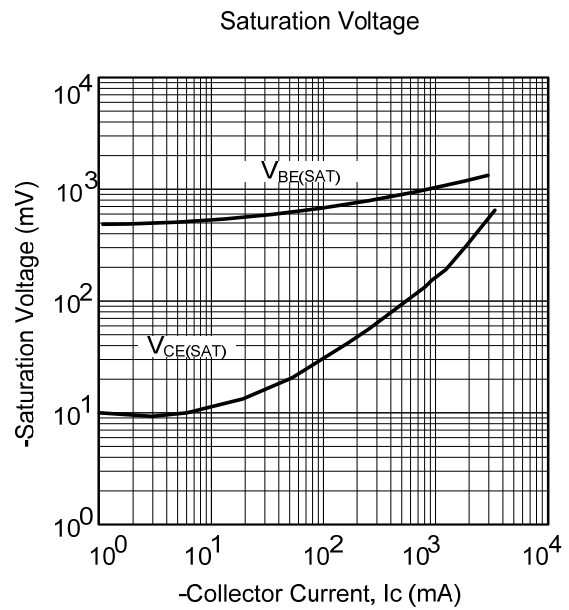
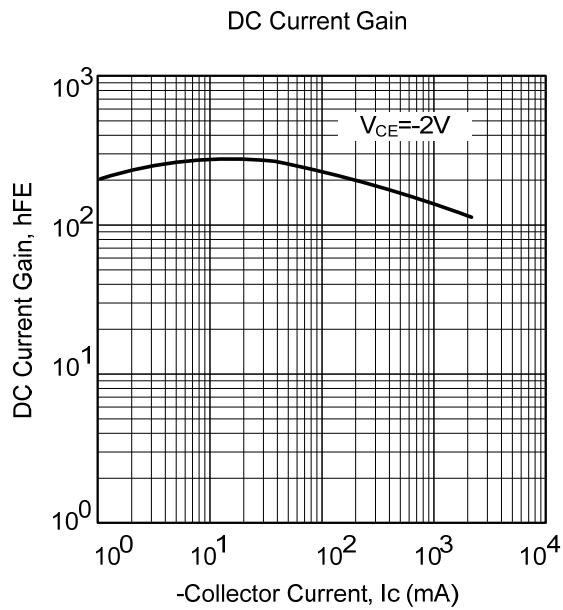

UTC assumes no responsibility for equipment failures that result from using products at values that exceed, even momentarily, rated values (such as maximum ratings, operating condition ranges, or other parameters) listed in products specifications of any and all UTC products described or contained herein. UTC products are not designed for use in life support appliances, devices or systems where malfunction of these products can be reasonably expected to result in personal injury. Reproduction in whole or in part is prohibited without the prior written consent of the copyright owner. UTC reserves the right to make changes to information published in this document, including without limitation specifications and product descriptions, at any time and without notice. This document supersedes and replaces all information supplied prior to the publication hereof.