



LR2125

LINEAR INTEGRATED CIRCUIT

300mA SELECTABLE FIXED/ADJUSTABLE LOW DROPOUT LINEAR REGULATOR

DESCRIPTION

As a low dropout linear regulator, the UTC **LR2125** only needs low input voltage (2.8~6V) and can deliver current to 300mA for setting the output voltage.

The UTC **LR2125** is an ideal for being used in such battery-powered equipments notebook, personal computer and cellular phone. Its typical dropout voltage is 230mV at loading current 300mA.

For setting the output voltage, the UTC **LR2125** has two output voltage operation modes: fixed mode senses the output voltage on V_{OUT} , ADJ mode needs two resistors as a voltage divider.

To protect itself against current over-loads and over temperature, the **LR2125** has current limit and thermal shutdown functions.

FEATURES

- * Operating Voltage: 2.8~6V
- * Low Voltage Dropout
- * Output Current Guaranteed 300mA
- * For Setting Output Voltage Two Modes
 - Fixed mode :Fixed Output Voltage 1~5V
 - ADJ mode: Adjustable Output Voltage 0.8~5.5V
- * Internal Current Limit Protection
- * With Soft-Start
- * Internal thermal Protection
- * Work stably with Low ESR Ceramics Capacitor

ORDERING INFORMATION

Ordering Number		Package	Packing
Lead Free	Halogen Free		
LR2125L-xx-AF5-R	LR2125G-xx-AF5-R	SOT-25	Tape Reel

LR2125G-xx-AF5-R 	(1)Packing Type (2)Package Type (3)Output Voltage Code (4)Green Package	(1) R: Tape Reel (2) AF5: SOT-25 (3) xx: Refer to Marking Information (4) G: Halogen Free and Lead Free
----------------------	--	--

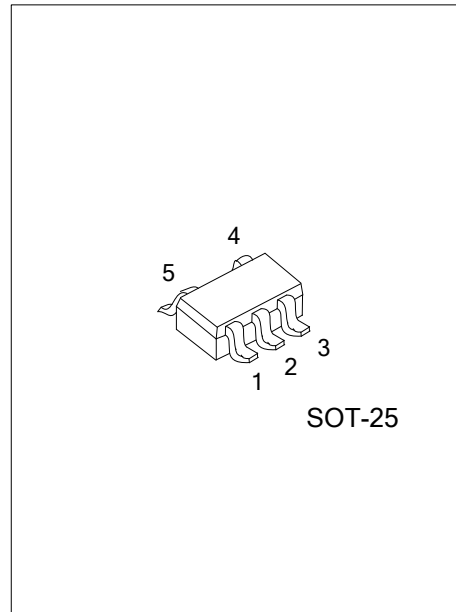

MARKING INFORMATION

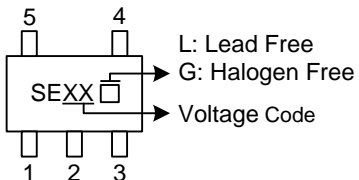
PACKAGE	VOLTAGE CODE	MARKING
SOT-25	12: 1.2V 18: 1.8V 25: 2.5V 33: 3.3V AD: ADJ	 <p>L: Lead Free G: Halogen Free Voltage Code</p>

PIN CONFIGURATION

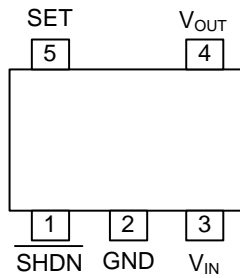

PIN DESCRIPTION

PIN NO	PIN NAME	DESCRIPTION
1	$\overline{\text{SHDN}}$	Control pin for shutdown
		Logic High: enable
		Logic Low: shutdown
2	GND	Ground
3	V_{IN}	Voltage supply
4	V_{OUT}	Output pin
5	SET	When this pin is connected to ground, turns to fixed output voltage operation. When this pin is connected to an external resistor divider, turns to adjustable output voltage mode operation.

■ BLOCK DIAGRAM

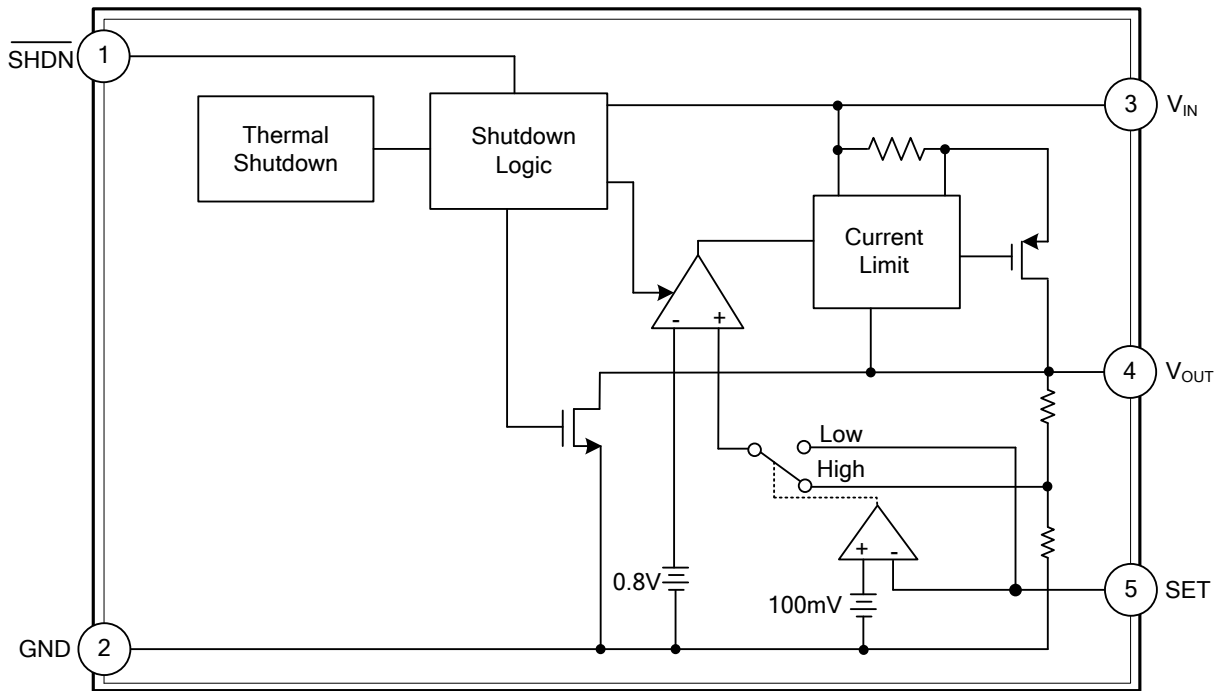

■ **ABSOLUTE MAXIMUM RATING** ($T_A = 25^\circ\text{C}$, Unless otherwise specified)

PARAMETER	SYMBOL	RATINGS	UNIT
V_{IN} Supply Voltage (V_{IN} to GND)	V_{IN}	-0.3 ~ +6.5	V
SHDN Input Voltage (SHDN to GND)	V_{SHDN}	-0.3 ~ +6.5	V
Power Dissipation	P_D	380	mW
Junction Temperature	T_J	-40 ~ +150	$^\circ\text{C}$
Storage Temperature	T_{STG}	-65 ~ +150	$^\circ\text{C}$

Note: Absolute maximum ratings are those values beyond which the device could be permanently damaged. Absolute maximum ratings are stress ratings only and functional device operation is not implied.

■ **RECOMMENDED OPERATING CONDITIONS**

PARAMETER	SYMBOL	RATINGS	UNIT
V_{IN} Supply Voltage	V_{IN}	2.8 ~ 6	V
Output Voltage	V_{OUT}	0.8 ~ 5.5	V
V_{OUT} Output Current	I_{OUT}	0 ~ 300	mA
Input Capacitor	C_{IN}	0.22 ~ 100	μF
Output Capacitor	C_{OUT}	1.5 ~ 33	μF
Junction Temperature	T_{OPR}	-40 ~ +125	$^\circ\text{C}$

■ **ELECTRICAL CHARACTERISTICS**

($V_{IN} = V_{OUT} + 1\text{V}$ (min $V_{IN} = 2.8\text{V}$), $I_{OUT} = 0 \sim 300\text{mA}$, $C_{IN} = 1\mu\text{F}$, $C_{OUT} = 2.2\mu\text{F}$, $T_A = 25^\circ\text{C}$, unless otherwise specified)

PARAMETER	SYMBOL	TEST CONDITIONS	MIN	TYP	MAX	UNIT
Output Voltage	V_{OUT}		0.8		5.5	V
Input Voltage	V_{IN}		2.8		6	V
Line Regulation	$\frac{\Delta V_{OUT}}{\Delta V_{IN} \times V_{OUT}}$	$\Delta V_{OUT}\% / \Delta V_{IN}$, $I_{OUT} = 10\text{mA}$	-0.07		+0.07	%/V
Load Regulation	$\frac{\Delta V_{OUT}}{\Delta I_{OUT} \times V_{OUT}}$	$\Delta V_{OUT}\% / \Delta I_{OUT}$	-0.4		+0.4	%/A
Output Voltage Accuracy		Fixed output voltage, $I_{OUT} = 10\text{mA}$	-2		+2	%
Reference Voltage	V_{REF}	Measured on SET, $V_{IN} = 2.8\text{V}$, $I_{OUT} = 10\text{mA}$	0.784	0.8	0.816	V
Quiescent Current	I_Q	$I_{OUT} = 10\text{mA} \sim 300\text{mA}$		135	160	μA
Dropout Voltage	V_D	$V_{OUT} = 2.5\text{V}$, $I_{OUT} = 300\text{mA}$		230	360	mV
		$V_{OUT} = 3.3\text{V}$, $I_{OUT} = 300\text{mA}$		170	300	mV
Power Supply Ripple Rejection Ratio	PSRR	$f = 10\text{kHz}$, $I_{OUT} = 300\text{mA}$		45		dB
Output Voltage Noise	eN	$f = 80\text{Hz} \sim 100\text{kHz}$, $I_{OUT} = 300\text{mA}$		160		μV_{RMS}
Current Limit	I_{LIMIT}		400	500	650	mA
Shutdown Threshold	V_{IH}		1.6			V
	V_{IL}				0.4	V
Shutdown Supply Current	I_{OFF}	$\overline{\text{SHDN}} = \text{Low}$, $V_{IN} = 6\text{V}$		0.1	1	μA
V_{OUT} Discharge MOSFET $R_{DS(ON)}$		$\overline{\text{SHDN}} = \text{Low}$		60		Ω
Thermal Shutdown Temperature	T_{SHDN}			160		$^\circ\text{C}$
Thermal Shutdown Hysteresis	DT_{SHDN}			40		$^\circ\text{C}$
SET Input Threshold for Fixed/Adjustable Output Voltage Mode				100		mV
SET Input Bias Current			-100		100	nA
Soft-Start Interval	T_{SS}			60		μs

■ APPLICATION INFORMATION

Input Capacitor

Value :

Larger than 1μF, at least a 1μF ceramic capacitor

Place :

Be placed near the V_{IN} very closely

Purpose and Advantage Description :

To prevent the input rail from dropping, this capacitor can provide surge current as while as the circuit's stepping load transients.

Output Capacitor

Value :

Larger than 2.2μF

Place :

Be placed at the load and near the GND pin very closely.

Purpose and Advantage Description :

Mainly make sure the circuit's operating stability. And the large value capacitor also can reduce noise and improve transient response. Additionally, it can affect power on issue.

$$C_{OUT(max)} = 87 \times \left(0.55 - \frac{0.1155}{V_{OUT}} \right)$$

Maximum Output Capacitor's Value (μF) and the Output Voltage (V)'s Value's Relationship

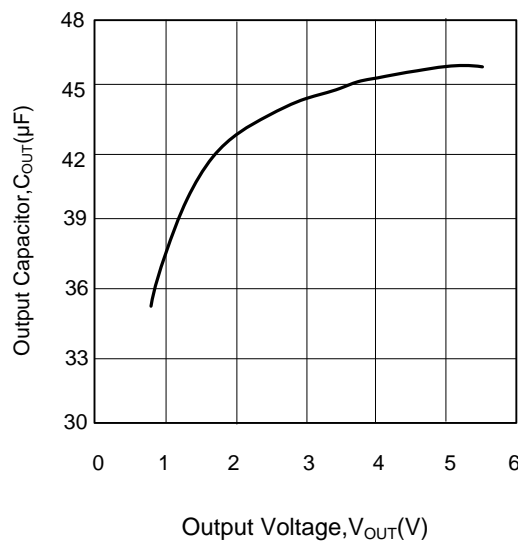

Maximum Output Capacitor's Changing Over V_{OUT} .

■ TYPICAL APPLICATION CIRCUITS

For Fixed Output Voltage Mode

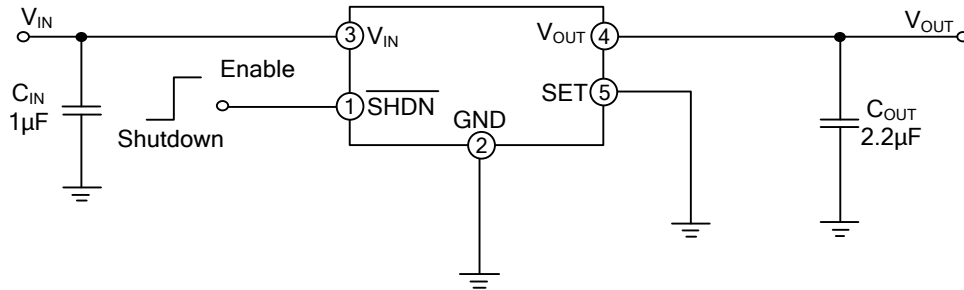

For Adjustable Output Voltage Mode

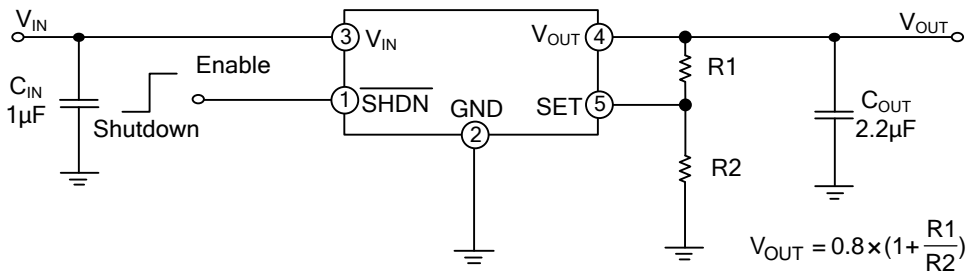

Note : The recommended value of R2 is in the range of 100 to 100kΩ.

■ TYPICAL CHARACTERISTICS

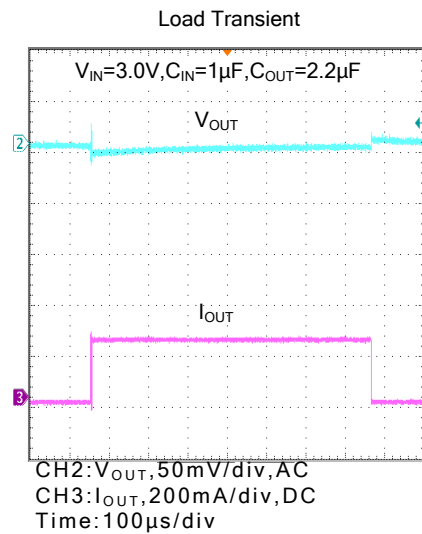
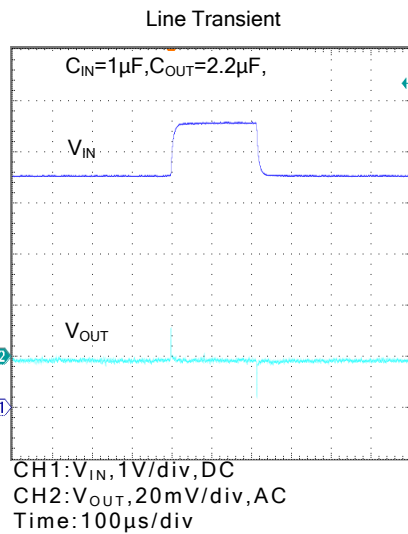
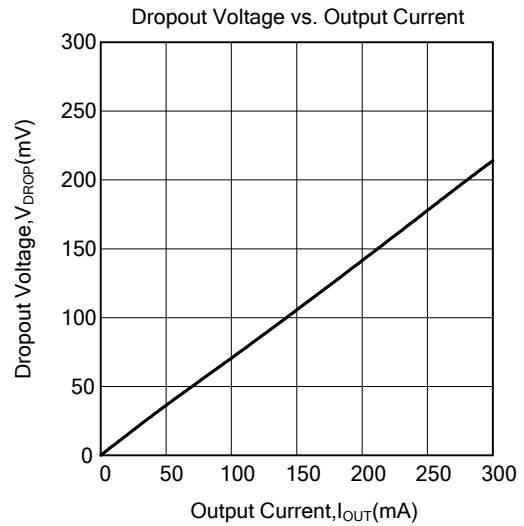
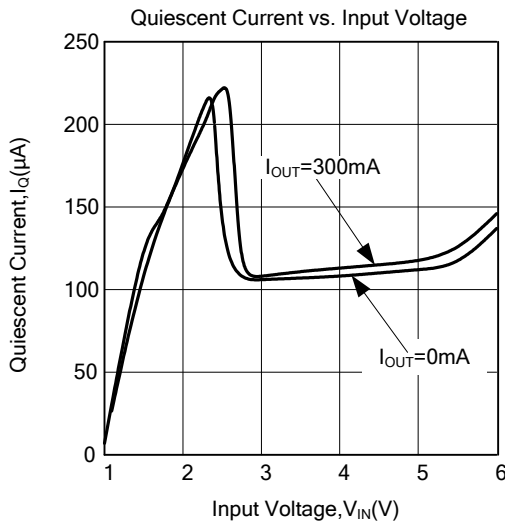
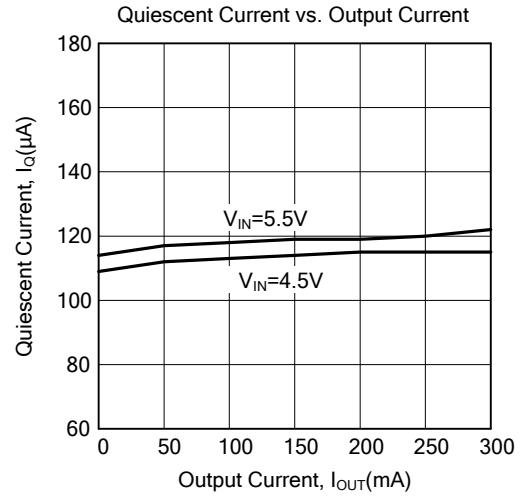
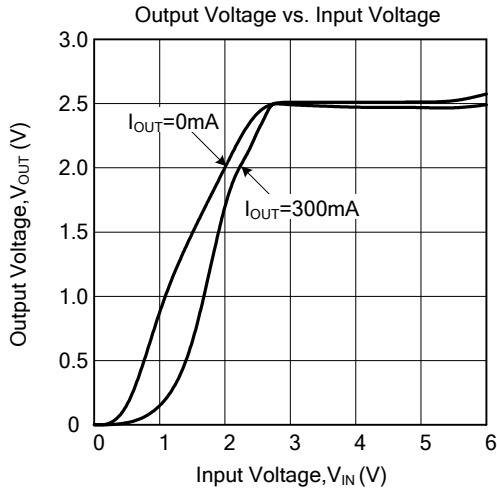

■ TYPICAL CHARACTERISTICS(Cont.)

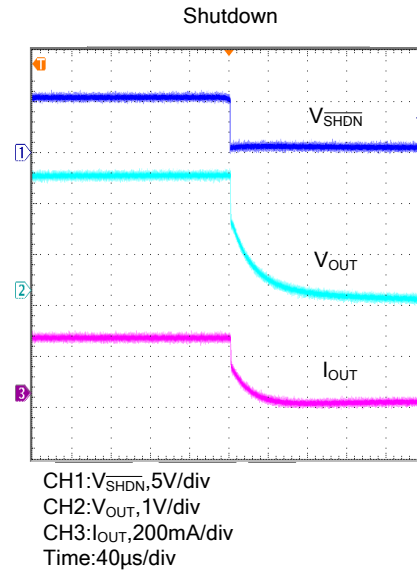
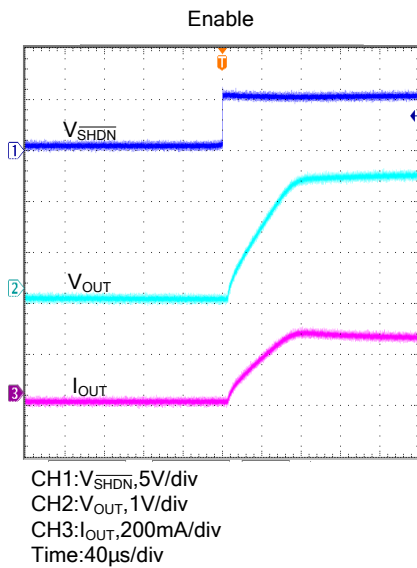

UTC assumes no responsibility for equipment failures that result from using products at values that exceed, even momentarily, rated values (such as maximum ratings, operating condition ranges, or other parameters) listed in products specifications of any and all UTC products described or contained herein. UTC products are not designed for use in life support appliances, devices or systems where malfunction of these products can be reasonably expected to result in personal injury. Reproduction in whole or in part is prohibited without the prior written consent of the copyright owner. UTC reserves the right to make changes to information published in this document, including without limitation specifications and product descriptions, at any time and without notice. This document supersedes and replaces all information supplied prior to the publication hereof.