

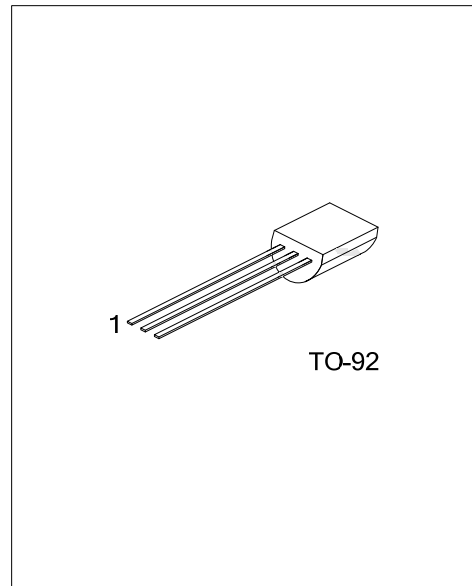

MCR101

SCR

SENSITIVE GATE SILICON CONTROLLED RECTIFIERS REVERSE BLOCKING THYRISTORS



■ **DESCRIPTION**

PNPN devices designed for high volume, line-powered consumer applications such as relay and lamp drivers, small motor controls, gate drivers for larger thrusters, and sensing and detection circuits. Supplied in an inexpensive plastic TO-92 package which is readily adaptable for use in automatic insertion equipment.

■ **FEATURES**

- *Sensitive Gate Allows Triggering by Micro Controllers and other Logic Circuits
- *Blocking Voltage to 600V
- *On-State Current Rating of 0.8A RMS at 80°C
- *High Surge Current Capability – 10A
- *Minimum and Maximum Values of I_{GT}, V_{GT} and I_H Specified for Ease of Design
- *Immunity to dV/dt – 20V/μsec Minimum at 110°C
- *Glass-Passivated Surface for Reliability and Uniformity

■ **ORDERING INFORMATION**

Ordering Number		Package	Pin Assignment			Packing
Lead Free	Halogen Free		1	2	3	
MCR101L-x-xx-T92-B	MCR101G-x-xx-T92-B	TO-92	G	A	K	Tape Box
MCR101L-x-xx-T92-K	MCR101G-x-xx-T92-K	TO-92	G	A	K	Bulk

Note: Pin Assignment: G: Gate A: Anode K: Cathode

<p>MCR101G-x-xx-T92-B</p>	<p>(1) B: Tape Reel, K: Bulk</p> <p>(2) T92: TO-92</p> <p>(3) xx: refer to Classification of I_{GT}</p> <p>(4) 4: 200V, 6: 400V, 8: 600V</p> <p>(5) G: Halogen Free and Lead Free, L: Lead Free</p>
---------------------------	---

■ **MARKING**

MCR101-4	MCR101-6	MCR101-8

■ ABSOLUTE MAXIMUM RATINGS

PARAMETER	SYMBOL	RATINGS	UNIT
Peak Repetitive Off-State Voltage(note) ($T_J = -40$ to 110°C , Sine Wave, 50 to 60Hz; Gate Open)	MCR101-4	200	V
	MCR101-6	400	
	MCR101-8	600	
On-State RMS Current ($T_C = 80^\circ\text{C}$) 180° Condition Angles	$I_{T(RMS)}$	0.8	A
Peak Non-Repetitive Surge Current (1/2 cycle, Sine Wave, 60Hz, $T_J = 25^\circ\text{C}$)	I_{TSM}	10	A
Circuit Fusing Considerations ($t = 8.3$ ms)	I^2t	0.415	A^2s
Forward Peak Gate Power ($T_A = 25^\circ\text{C}$, Pulse Width $\leq 1.0\mu\text{s}$)	P_{GM}	0.1	W
Forward Average Gate Power ($T_A = 25^\circ\text{C}$, $t = 8.3\text{ms}$)	$P_{G(AV)}$	0.1	W
Peak Gate Current – Forward ($T_A = 25^\circ\text{C}$, Pulse Width $\leq 1.0\mu\text{s}$)	I_{GM}	1	A
Peak Gate Voltage – Reverse ($T_A = 25^\circ\text{C}$, Pulse Width $\leq 1.0\mu\text{s}$)	V_{GRM}	5	V
Operating Junction Temperature @ Rated V_{RRM} and V_{DRM}	T_J	-40 ~ +110	$^\circ\text{C}$
Storage Temperature	T_{STG}	-40 ~ +150	$^\circ\text{C}$

Note: V_{DRM} and V_{RRM} for all types can be applied on a continuous basis. Ratings apply for zero or negative gate voltage; however, positive gate voltage shall not be applied concurrent with negative potential on the anode. Blocking voltages shall not be tested with a constant current source such that the voltage ratings of the devices are exceeded.

■ THERMAL DATA

PARAMETER	SYMBOL	RATING	UNIT
Junction to Ambient	θ_{JA}	200	$^\circ\text{C/W}$
Junction to Case	θ_{JC}	75	$^\circ\text{C/W}$

■ ELECTRICAL CHARACTERISTICS ($T_J = 25^\circ\text{C}$, unless otherwise stated)

PARAMETER	SYMBOL	TEST CONDITIONS	MIN	TYP	MAX	UNIT
OFF CHARACTERISTICS						
Peak Forward or Reverse Blocking Current	I_{DRM}, I_{RRM}	$V_D = \text{Rated } V_{DRM} \text{ and } V_{RRM}; R_{GK} = 1\text{k}\Omega$			10	μA
					100	
ON CHARACTERISTICS						
Peak Forward On-State Voltage (Note1)	V_{TM}	$I_{TM} = 1\text{A Peak @ } T_A = 25^\circ\text{C}$			1.7	V
Gate Trigger Current (Continuous dc)	I_{GT}	$V_{AK} = 7\text{Vdc}, R_L = 100\Omega, T_C = 25^\circ\text{C}$		40	200	μA
Holding Current	I_H	$V_{AK} = 7\text{Vdc}, \text{initiating current} = 20\text{mA}$		0.5	5	mA
					10	
Latch Current	I_L	$V_{AK} = 7\text{V}, I_g = 200\mu\text{A}$		0.6	10	mA
					15	
Gate Trigger Current (continuous dc)	V_{GT}	$V_{AK} = 7\text{Vdc}, R_L = 100\Omega$		0.62	0.8	V
					1.2	
DYNAMIC CHARACTERISTICS						
Critical Rate of Rise of Off-State Voltage	dV/dt	$V_D = \text{Rated } V_{DRM}, \text{Exponential Waveform}, R_{GK} = 1000\Omega, T_J = 110^\circ\text{C}$	20	35		$\text{V}/\mu\text{s}$
Critical Rate of Rise of On-State Current	di/dt	$I_{PK} = 20\text{A}, P_w = 10\mu\text{sec}, diG/dt = 1\text{A}/\mu\text{sec}, I_{gt} = 20\text{mA}$			50	$\text{A}/\mu\text{s}$

Note: Indicates Pulse Test Width $\leq 1.0\text{ms}$, duty cycle $\leq 1\%$

■ VOLTAGE CURRENT CHARACTERISTIC OF SCR

SYMBOL	PARAMETER
V_{DRM}	Peak Repetitive Off Stat Forward Voltage
I_{DRM}	Peak Forward Blocking Current
V_{RRM}	Peak Repetitive Off State Reverse Voltage
I_{RRM}	Peak Reverse Blocking Current
V_{TM}	Peak On State Voltage
I_H	Holding Current

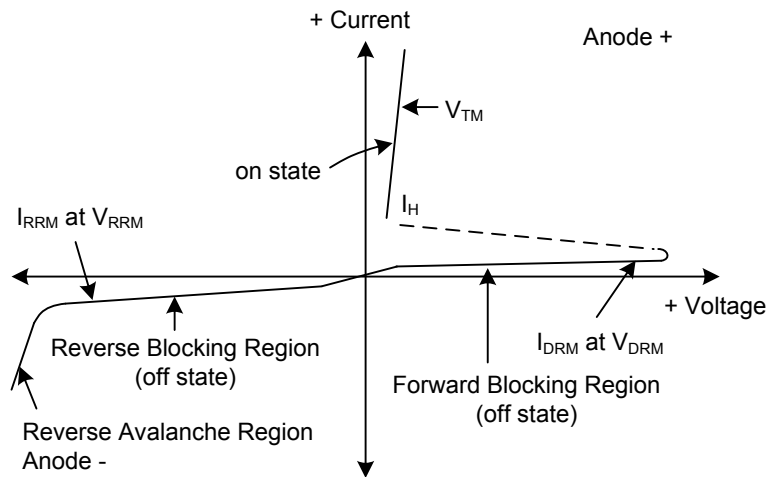

■ CLASSIFICATION OF I_{GT}

RANK	B	C	AA	AB	AC	AD
RANGE	48~105 μ A	95~200 μ A	8~16 μ A	14~21 μ A	19~25 μ A	23~52 μ A

TYPICAL CHARACTERISTICS

Figure 1. Typical Gate Trigger Current versus Junction Temperature

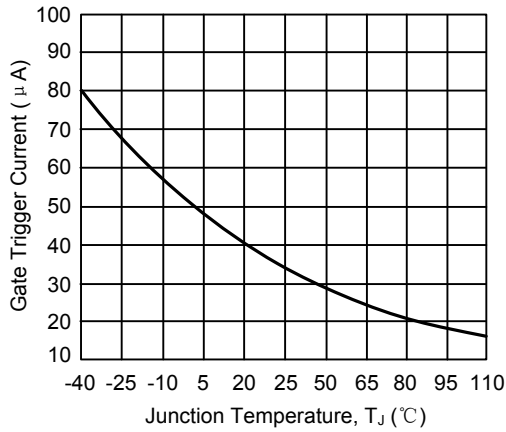

Figure 2. Typical Gate Trigger Voltage versus Junction Temperature

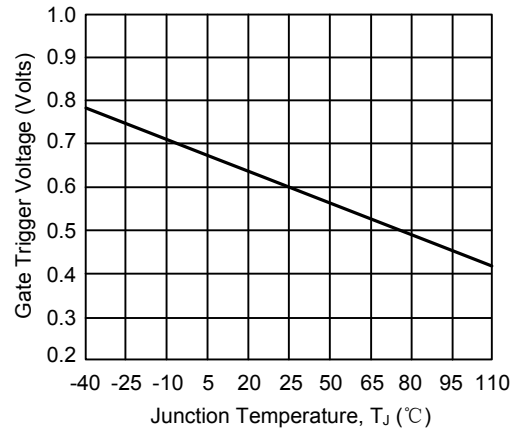

Figure 3. Typical Holding Current versus Junction Temperature

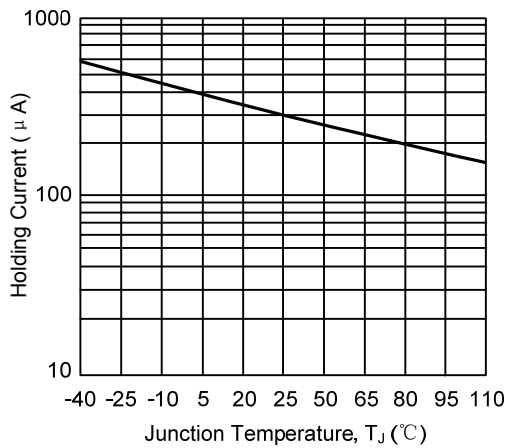

Figure 4. Typical Latching Current versus Junction Temperature

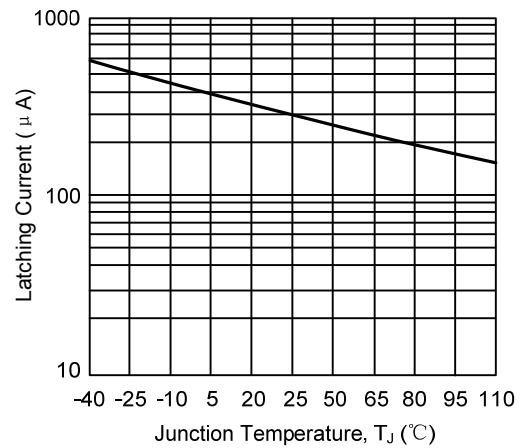

Figure 5. Typical RMS Current Derating

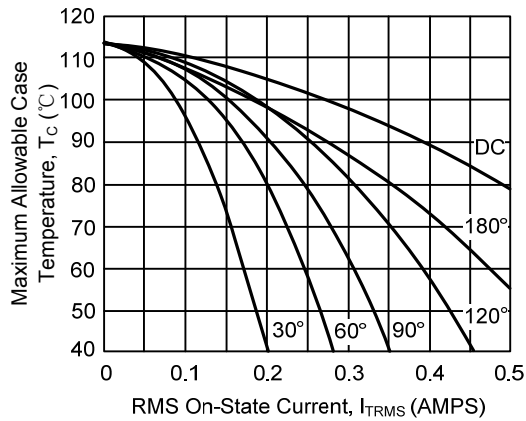
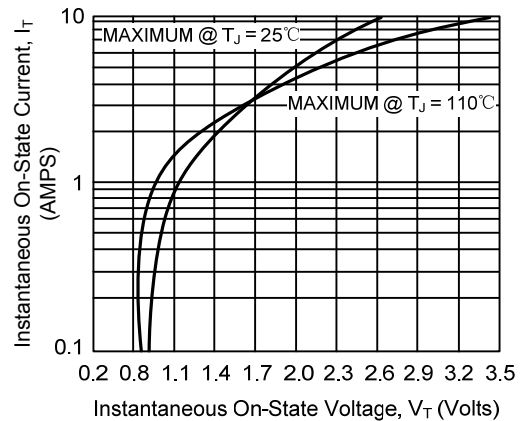

Figure 6. Typical On-State Characteristics



UTC assumes no responsibility for equipment failures that result from using products at values that exceed, even momentarily, rated values (such as maximum ratings, operating condition ranges, or other parameters) listed in products specifications of any and all UTC products described or contained herein. UTC products are not designed for use in life support appliances, devices or systems where malfunction of these products can be reasonably expected to result in personal injury. Reproduction in whole or in part is prohibited without the prior written consent of the copyright owner. UTC reserves the right to make changes to information published in this document, including without limitation specifications and product descriptions, at any time and without notice. This document supersedes and replaces all information supplied prior to the publication hereof.