



MMBTA14

NPN SILICON TRANSISTOR

DARLINGTON TRANSISTOR

DESCRIPTION

The UTC **MMBTA14** is a Darlington transistor.

FEATURES

- * Collector-Emitter Voltage: $V_{CES} = 30V$
- * Collector Dissipation: $P_{C(MAX)} = 350\text{ mW}$

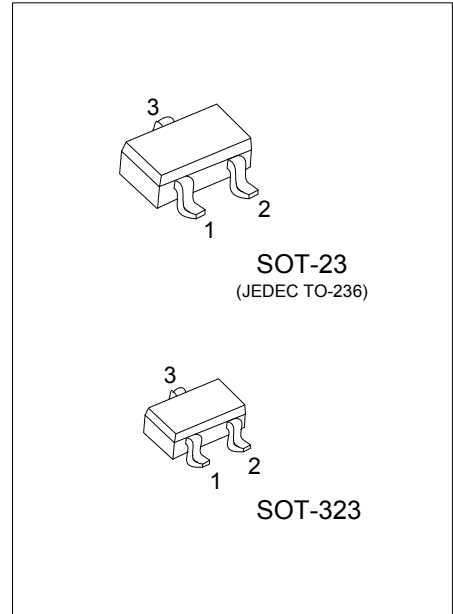

ORDERING INFORMATION

Ordering Number		Package	Pin Assignment			Packing
Lead Free	Halogen Free		1	2	3	
MMBTA14L-AE3-R	MMBTA14G-AE3-R	SOT-23	B	E	C	Tape Reel
MMBTA14L-AL3-R	MMBTA14G-AL3-R	SOT-323	B	E	C	Tape Reel

Note: Pin Assignment: B: Base E: Emitter C: Collector

MMBTA14G-AE3-R	(1)Packing Type	(1) R: Tape Reel
	(2)Package Type	(2) AE3: SOT-23, AL3: SOT-323
	(3)Green Package	(3) G: Halogen Free and Lead Free, L: Lead Free

MARKING

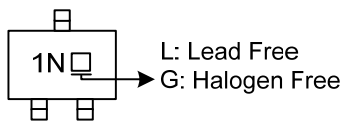

■ ABSOLUTE MAXIMUM RATING ($T_A=25^{\circ}\text{C}$, unless otherwise specified)

PARAMETER	SYMBOL	RATINGS	UNIT
Collector-Base Voltage	V_{CBO}	30	V
Collector-Emitter Voltage	V_{CES}	30	V
Emitter-Base Voltage	V_{EBO}	10	V
Collector Dissipation ($T_C=25^{\circ}\text{C}$)	P_C	350	mW
Collector Current	I_C	500	mA
Junction Temperature	T_J	+150	$^{\circ}\text{C}$
Storage Temperature	T_{STG}	-40 ~ +150	$^{\circ}\text{C}$

Note: Absolute maximum ratings are those values beyond which the device could be permanently damaged. Absolute maximum ratings are stress ratings only and functional device operation is not implied.

■ ELECTRICAL CHARACTERISTICS ($T_A=25^{\circ}\text{C}$, unless otherwise specified)

PARAMETER	SYMBOL	TEST CONDITIONS	MIN	TYP	MAX	UNIT
Collector-Emitter Breakdown Voltage	BV_{CES}	$I_C=100\mu\text{A}$, $I_B=0$	30			V
Collector CutOff Current	I_{CBO}	$V_{CB}=30\text{V}$, $I_E=0$			100	nA
Emitter CutOff Current	I_{EBO}	$V_{EB}=10\text{V}$, $I_C=0$			100	nA
DC Current Gain	h_{FE}	$V_{CE}=5\text{V}$, $I_C=100\text{ mA}$ (Note)	20000			
Collector-Emitter Saturation Voltage	$V_{CE(SAT)}$	$I_C=100\text{mA}$, $I_B=0.1\text{mA}$ (Note)			1.5	V
Base-Emitter on Voltage	$V_{BE(ON)}$	$V_{CE}=5\text{V}$, $I_C=100\text{mA}$ (Note)			2.0	V
Current Gain Bandwidth Product	f_T	$V_{CE}=5\text{V}$, $I_C=10\text{mA}$, $f=100\text{MHz}$	125			MHz

Note: Pulse Width < 300 μs , Duty Cycle \leq 2%.

TYPICAL CHARACTERISTICS

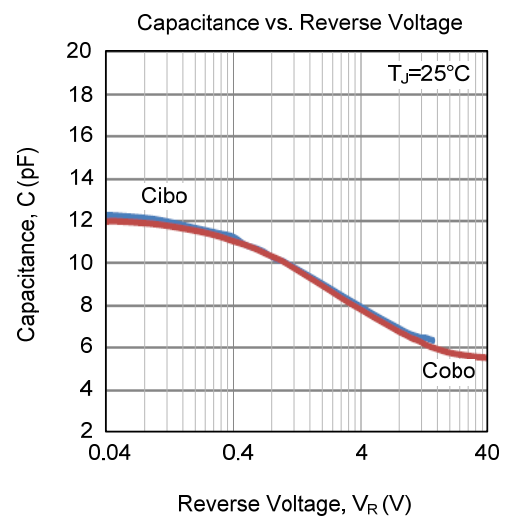
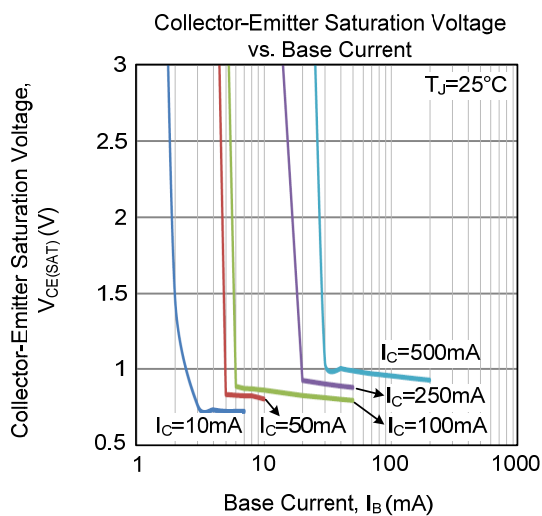
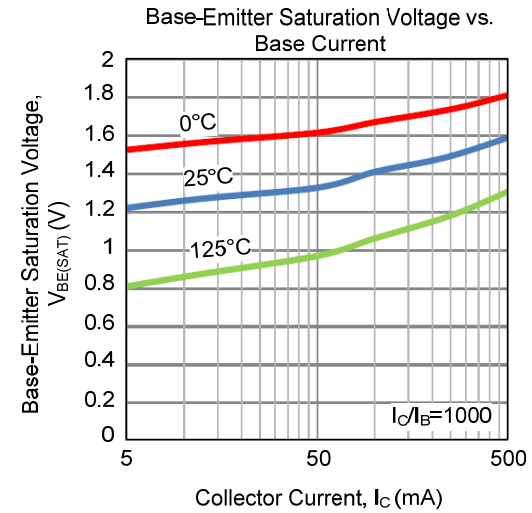
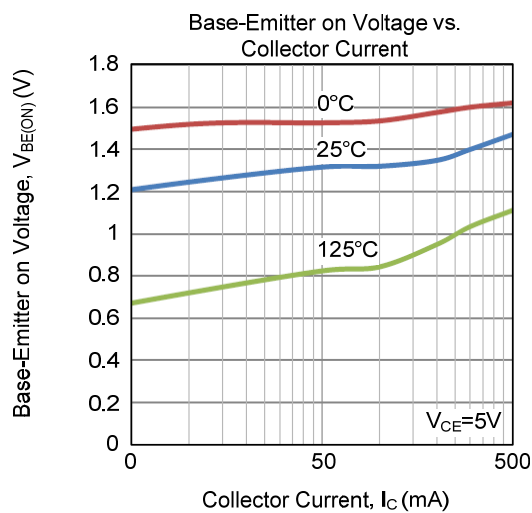
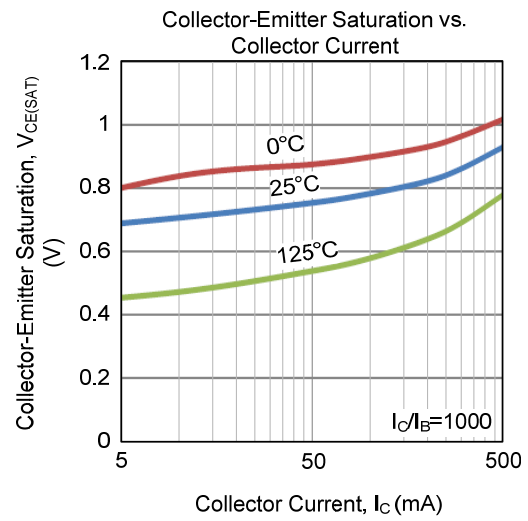
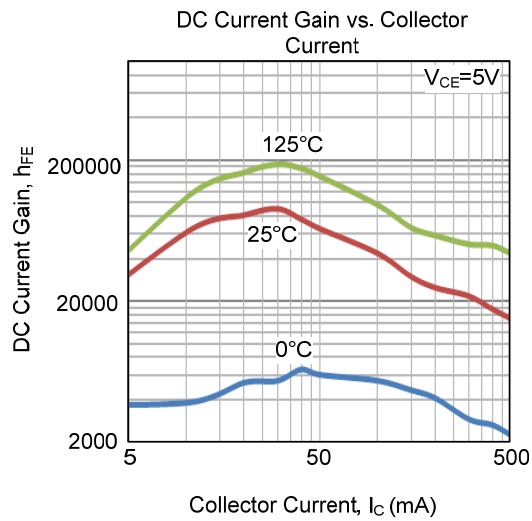

■ TYPICAL CHARACTERISTICS

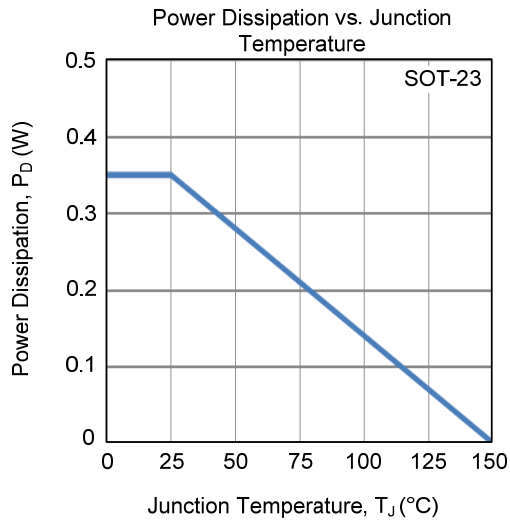

UTC assumes no responsibility for equipment failures that result from using products at values that exceed, even momentarily, rated values (such as maximum ratings, operating condition ranges, or other parameters) listed in products specifications of any and all UTC products described or contained herein. UTC products are not designed for use in life support appliances, devices or systems where malfunction of these products can be reasonably expected to result in personal injury. Reproduction in whole or in part is prohibited without the prior written consent of the copyright owner. UTC reserves the right to make changes to information published in this document, including without limitation specifications and product descriptions, at any time and without notice. This document supersedes and replaces all information supplied prior to the publication hereof.