



MMBTA94

PNP SILICON TRANSISTOR

HIGH VOLTAGE TRANSISTOR

FEATURES

- * Collector-Emitter Voltage: $V_{CE0} = -400V$
- * Collector Dissipation: $P_{C(MAX)} = 350mW$
- * Low Collector-Emitter Saturation Voltage

APPLICATIONS

- * Telephone Switching
- * High Voltage Switch

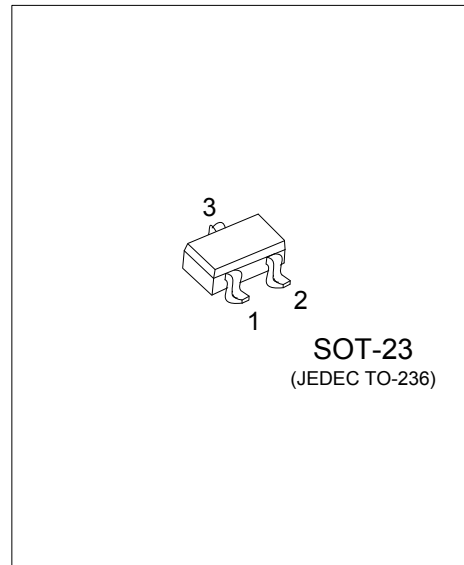

ORDERING INFORMATION

Ordering Number		Package	Pin Assignment			Packing
Lead Free	Halogen Free		1	2	3	
MMBTA94L-AE3-R	MMBTA94G-AE3-R	SOT-23	B	E	C	Tape Reel

Note: Pin Assignment: B: Base E: Emitter C: Collector

MMBTA94G-AE3-R	(1)Packing Type	(1) R: Tape Reel
	(2)Package Type	(2) AE3: SOT-23
	(3)Green Package	(3) G: Halogen Free and Lead Free, L: Lead Free

MARKING

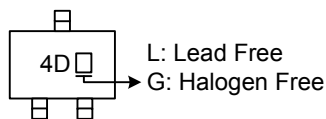

MMBTA94

PNP SILICON TRANSISTOR

■ ABSOLUTE MAXIMUM RATING ($T_A=25^\circ\text{C}$ unless otherwise specified)

PARAMETER	SYMBOL	RATING	UNIT	
Collector-Base Voltage	V_{CB0}	-400	V	
Collector-Emitter Voltage	V_{CEO}	-400	V	
Emitter-Base Voltage	V_{EBO}	-6	V	
Collector Current	DC	I_C	-300	mA
	Pulse	I_{CP}	-800	mA
Collector Current	Pulsed	I_{CM}	-800	mA
Collector Dissipation ($T_a=25^\circ\text{C}$)	P_C	350	mW	
Junction Temperature	T_J	+150	$^\circ\text{C}$	
Storage Temperature	T_{STG}	-40 ~ +150	$^\circ\text{C}$	

Note: Absolute maximum ratings are those values beyond which the device could be permanently damaged. Absolute maximum ratings are stress ratings only and functional device operation is not implied.

■ ELECTRICAL CHARACTERISTICS ($T_A=25^\circ\text{C}$, unless otherwise specified)

PARAMETER	SYMBOL	TEST CONDITIONS	MIN	TYP	MAX	UNIT
Collector-Base Breakdown Voltage	BV_{CBO}	$I_C = -100\mu\text{A}, I_E=0$	-400			V
Collector-Emitter Breakdown Voltage	BV_{CEO}	$I_C = -1\text{mA}, I_B=0$	-400			V
Collector-Emitter Breakdown Voltage	BV_{CES}	$I_C = -100\mu\text{A}, V_{BE}=0$	-400			V
Emitter-Base Breakdown Voltage	BV_{EBO}	$I_E = -100\mu\text{A}, I_C=0$	-5			V
Collector Cut-off Current	I_{CBO}	$V_{CB} = -300\text{V}, I_E=0$			-100	nA
Collector Cut-off Current	I_{CES}	$V_{CB} = -400\text{V}, V_{BE}=0$			-1	μA
Emitter Cut-off Current	I_{EBO}	$V_{EB} = -4\text{V}, I_C=0$			100	nA
DC Current Gain (Note)	h_{FE}	$V_{CE} = -10\text{V}, I_C = -1\text{mA}$	60			
		$V_{CE} = -10\text{V}, I_C = -10\text{mA}$	70		300	
		$V_{CE} = -10\text{V}, I_C = -50\text{mA}$	70			
		$V_{CE} = -10\text{V}, I_C = -100\text{mA}$	40			
Collector-Emitter Saturation Voltage	$V_{CE(SAT)}$	$I_C = -10\text{mA}, I_B = -1\text{mA}$			-0.20	V
		$I_C = -50\text{mA}, I_B = -5\text{mA}$			-0.5	V
Base-Emitter Saturation Voltage	$V_{BE(SAT)}$	$I_C = -10\text{mA}, I_B = -1\text{mA}$			-0.75	V
Output Capacitance	C_{ob}	$V_{CB} = -20\text{V}, I_E=0, f = 1\text{MHz}$			7	pF

Note: Pulse test: Pulse Width $\leq 300\mu\text{s}$, Duty Cycle $\leq 2\%$.

TYPICAL CHARACTERISTICS

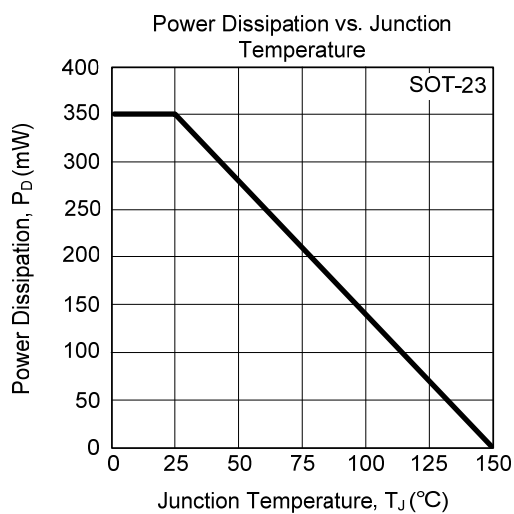
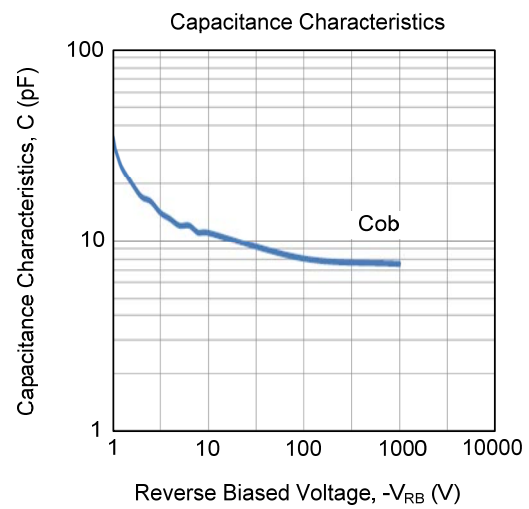
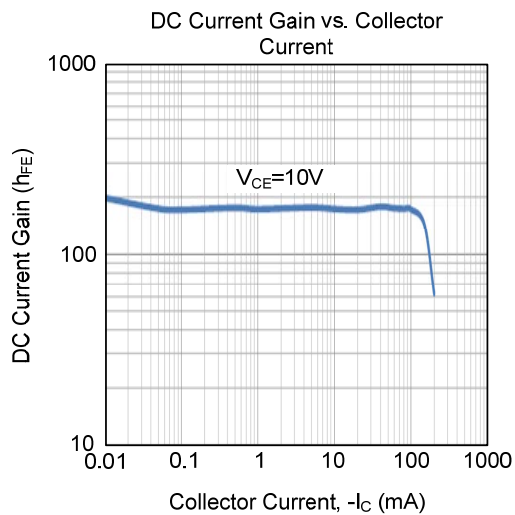
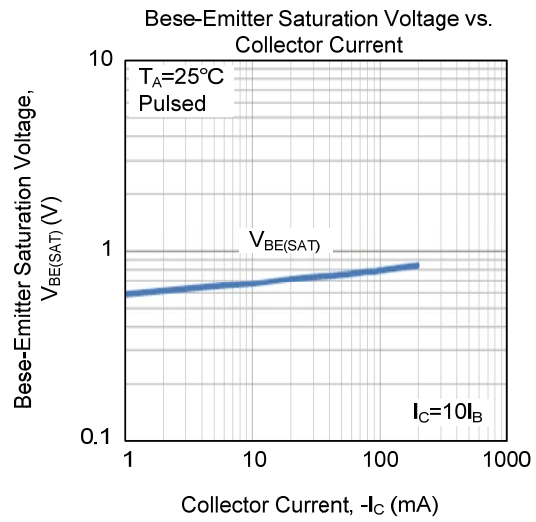
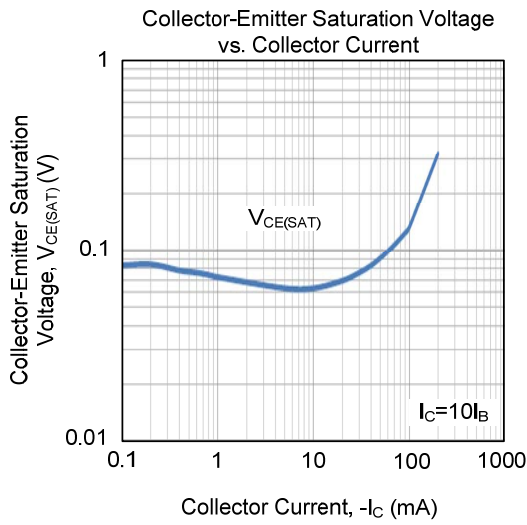

UTC assumes no responsibility for equipment failures that result from using products at values that exceed, even momentarily, rated values (such as maximum ratings, operating condition ranges, or other parameters) listed in products specifications of any and all UTC products described or contained herein. UTC products are not designed for use in life support appliances, devices or systems where malfunction of these products can be reasonably expected to result in personal injury. Reproduction in whole or in part is prohibited without the prior written consent of the copyright owner. UTC reserves the right to make changes to information published in this document, including without limitation specifications and product descriptions, at any time and without notice. This document supersedes and replaces all information supplied prior to the publication hereof.