



UNISONIC TECHNOLOGIES CO., LTD

MPSA56

PNP SILICON TRANSISTOR

PNP MPSA56

FEATURES

- * Collector-Emitter Voltage: $V_{CE0}=80V$
- * Collector Dissipation: $P_D=625mW$

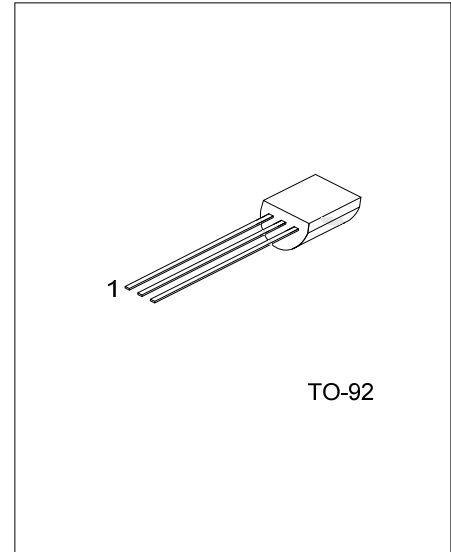

ORDERING INFORMATION

Ordering Number		Package	Pin Assignment			Packing
Lead Free	Halogen Free		1	2	3	
MPSA56L-T92-B	MPSA56G-T92-B	TO-92	E	B	C	Tape Box
MPSA56L-T92-K	MPSA56G-T92-K	TO-92	E	B	C	Bulk

Note: Pin Assignment: E: Emitter B: Base C: Collector

<p>MPSA56G-T92-B</p> <p>(1) Packing Type</p> <p>(2) Package Type</p> <p>(3) Green Package</p>	<p>(1) B: Tape Box, K: Bulk</p> <p>(2) T92: TO-92</p> <p>(3) G: Halogen Free and Lead Free, L: Lead Free</p>
---	--

MARKING

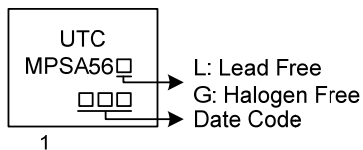

■ ABSOLUTE MAXIMUM RATING ($T_A=25^\circ\text{C}$, unless otherwise specified)

PARAMETER	SYMBOL	RATINGS	UNIT	
Collector-Base Voltage	V_{CBO}	-80	V	
Collector-Emitter Voltage	V_{CEO}	-80	V	
Emitter-Base Voltage	V_{EBO}	-4	V	
Collector Current - Continuous	I_C	-500	mA	
Total device Dissipation	$T_A=25^\circ\text{C}$	P_D	625	mW
Linear Derating Factor above			5	mW/ $^\circ\text{C}$
Total device Dissipation	$T_C=25^\circ\text{C}$	P_D	1500	mW
Linear Derating Factor above			12	mW/ $^\circ\text{C}$
Junction Temperature	T_J	+125	$^\circ\text{C}$	
Storage Temperature	T_{STG}	-55 ~ +150	$^\circ\text{C}$	

Note: Absolute maximum ratings are those values beyond which the device could be permanently damaged.

Absolute maximum ratings are stress ratings only and functional device operation is not implied.

■ THERMAL DATA

PARAMETER	SYMBOL	RATINGS	UNIT
Junction to Ambient	θ_{JA}	200	$^\circ\text{C}/\text{W}$
Junction to Case	θ_{JC}	83.3	$^\circ\text{C}/\text{W}$

■ ELECTRICAL CHARACTERISTICS ($T_A=25^\circ\text{C}$, unless otherwise specified)

PARAMETER	SYMBOL	TEST CONDITIONS	MIN	TYP	MAX	UNIT
OFF CHARACTERISTICS						
Collector-Emitter Breakdown Voltage (Note 1)	BV_{CEO}	$I_C=-1.0\text{mA}, I_B=0$	-80			V
Emitter-Base Breakdown Voltage	BV_{EBO}	$I_E=-100\mu\text{A}, I_C=0$	-4			V
Collector Cutoff Current	I_{CEO}	$V_{CE}=-60\text{V}, I_B=0$			-0.1	μA
Collector Cutoff Current	I_{CBO}	$V_{CB}=-80\text{V}, I_E=0$			-0.1	μA
ON CHARACTERISTICS						
Dc Current Gain	h_{FE}	$I_C=-10\text{mA}, V_{CE}=-1\text{V}$	100			
		$I_C=-100\text{mA}, V_{CE}=-1\text{V}$	100			
Collector-Emitter Saturation Voltage	$V_{CE(SAT)}$	$I_C=-100\text{mA}, I_B=-10\text{mA}$			-0.25	V
Base-Emitter On Voltage	$V_{BE(ON)}$	$I_C=-100\text{mA}, V_{CE}=-1\text{V}$			-1.2	V
SMALL-SIGNAL CHARACTERISTICS						
Current Gain Bandwidth Product (Note 2)	f_T	$I_C=-100\text{mA}, V_{CE}=-1\text{V}, f=100\text{MHz}$	50			MHz

Note 1. Pulse test: $PW \leq 300\mu\text{s}$, Duty Cycle $\leq 2\%$

2. f_T is defined as the frequency at which I_{hfe} extrapolates to unity.

TYPICAL CHARACTERISTICS

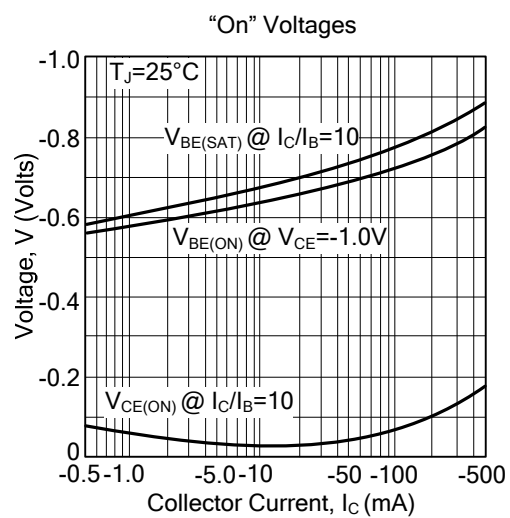
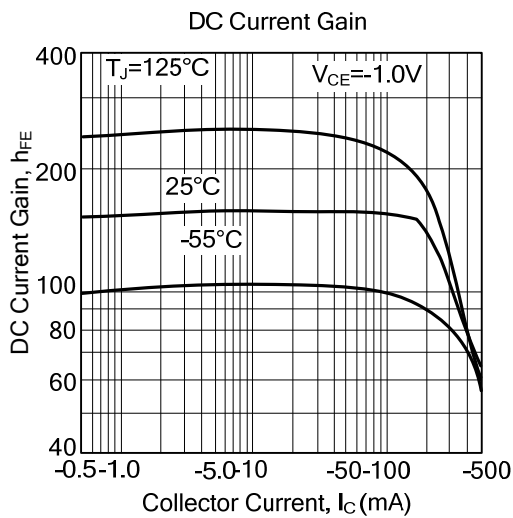
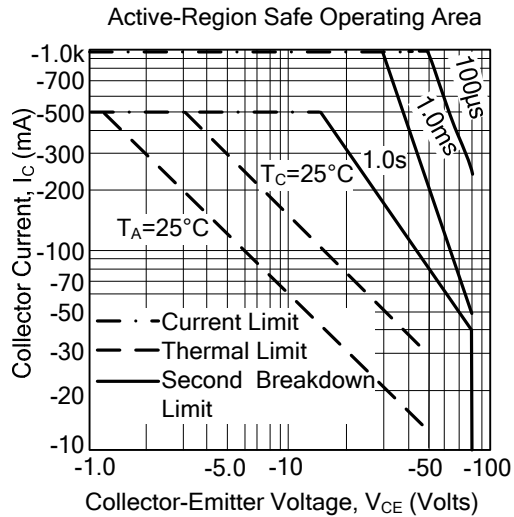
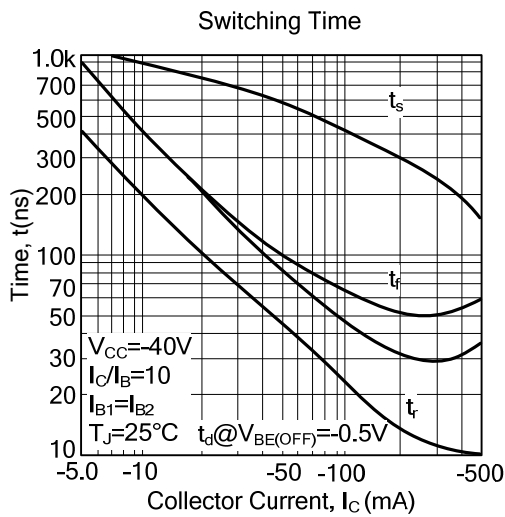
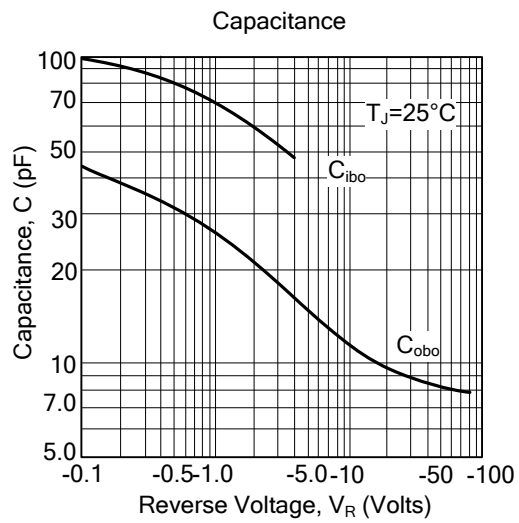
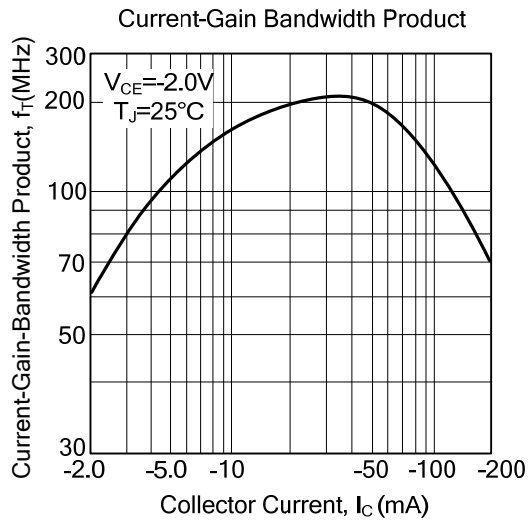

■ TYPICAL CHARACTERISTICS (Cont.)

Collector Saturation Region

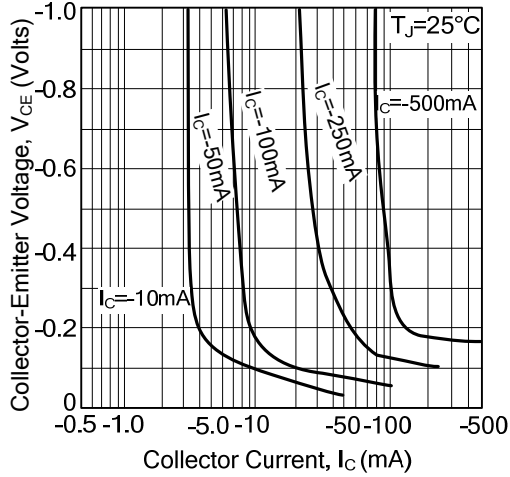

Base-Emitter Temperature Coefficient

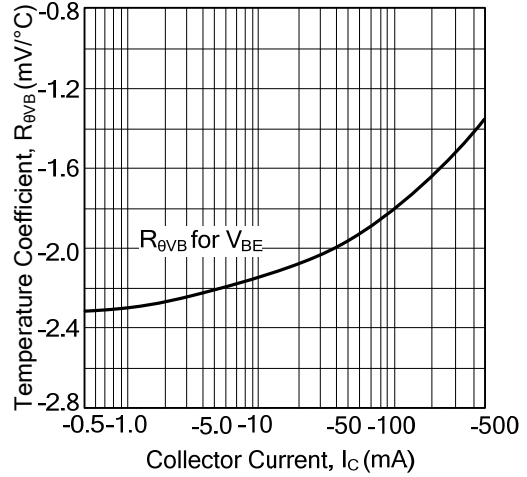

Thermal Response

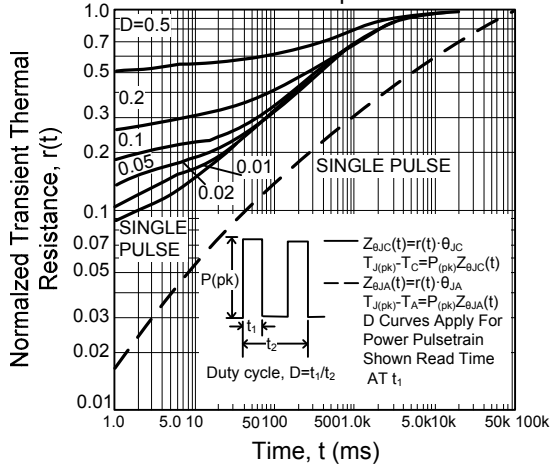

UTC assumes no responsibility for equipment failures that result from using products at values that exceed, even momentarily, rated values (such as maximum ratings, operating condition ranges, or other parameters) listed in products specifications of any and all UTC products described or contained herein. UTC products are not designed for use in life support appliances, devices or systems where malfunction of these products can be reasonably expected to result in personal injury. Reproduction in whole or in part is prohibited without the prior written consent of the copyright owner. UTC reserves the right to make changes to information published in this document, including without limitation specifications and product descriptions, at any time and without notice. This document supersedes and replaces all information supplied prior to the publication hereof.