



## PA7469

CMOS IC

### STEREO 2.6W AUDIO POWER AMPLIFIER (WITH DC\_VOLUME CONTROL)

#### DESCRIPTION

As an audio power amplifier, UTC **PA7469** can provides precise DC volume control, and a stereo bridged audio power amplifiers capable of producing 2.6Ω(1.8W) into 4W with less than 10% (1.0%)THD+N.

In UTC **PA7469**, the attenuator range of the volume control is from 20dB (DC\_Vol=0V) to -80dB (DC\_Vol=3.54V) with 32 steps.

It also includes both of the depop circuitry and the thermal shutdown protection circuitry which can reduce pops and clicks noise during power up or shutdown mode operation. It also improves the power off pop noise and has the parts to not been destroyed by over temperature and short current failure.

Into a single UTC **PA7469** chip, there are a stereo bridge-tied loads (BTL) mode for speaker drive and a stereo single-end (SE) mode for headphone drive into a single chip, which built to simplify the audio system design. And both modes are easily switched by the SE/BTL input control pin signal.

#### FEATURES

- \* Low operating current: 9mA
- \* Two output modes allowable with BTL and SE modes selected by SE/BTL pin
- \* Low current consumption in shutdown mode :1μA
- \* Short circuit protection
- \* Thermal shutdown protection and over current protection circuitry
- \* Improved depop circuitry to eliminate turn-on and turn-off transients in outputs
- \* Very high PSRR
- \* 32 Steps volume adjustable
- \* BTL mode: 2.6W per channel output power into 4Ω Load at 5V

#### ORDERING INFORMATION

Ordering Number			Package	Packing
Normal	Lead Free Plating	Halogen-Free Plating		
PA7469-D16-T	PA7469L-D16-T	PA7469G-D16-T	DIP-16	Tube
PA7469-S16-T	PA7469L-S16-T	PA7469G-S16-T	SOP-16	Tube
PA7469-S16-R	PA7469L-S16-R	PA7469G-S16-R	SOP-16	Tape Reel

<p>PA7469L-D16-T</p> <p>(1)Packing Type (2)Package Type (3)Lead Plating</p>	<p>(1) R: Tape Reel, T: Tube (2) D16: DIP-16, S08: SOP-16 (3) G: Halogen Free, L: Lead Free Plating, Blank: Pb/Sn</p>
---	---

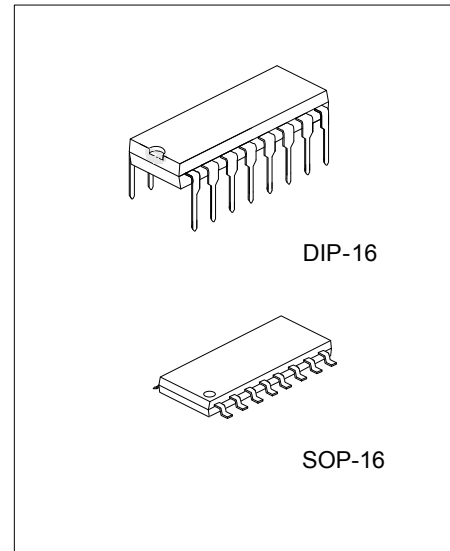

\* Product number:  
Lead-free: PA7469L  
Halogen-free: PA7469G

## ■ PIN CONFIGURATION

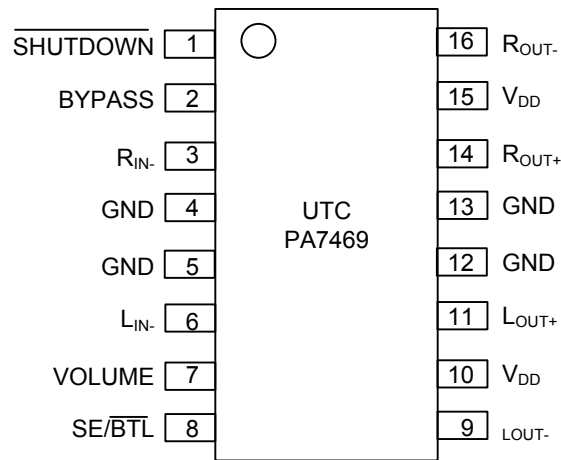

## ■ PIN DESCRIPTION

PIN NO	PIN NAME	I/O	DESCRIPTION
1	SHUTDOWN	I	When this pin is pulled low the chip will be into shutdown mode. $I_{SD} = 1\mu A$
2	BYPASS	I	Bias voltage generator
3	R <sub>IN-</sub>	I	Right channel input
4,5,12,13	GND		Ground
6	L <sub>IN-</sub>	I	Left channel input
7	VOLUME	I	Volume gain setting input signal
8	SE/ BTL	I	Output mode control input, High: SE output mode, Low: for BTL mode.
9	L <sub>OUT-</sub>	O	Left channel positive output in BTL mode and SE mode.
10,15	V <sub>DD</sub>		Supply voltage
11	L <sub>OUT+</sub>	O	Left channel negative output in BTL mode High impedance in SE mode.
14	R <sub>OUT+</sub>	O	Right channel negative output in BTL mode High impedance in SE mode.
16	R <sub>OUT-</sub>	O	Right channel positive output in BTL mode and SE mode.

■ BLOCK DIAGRAM

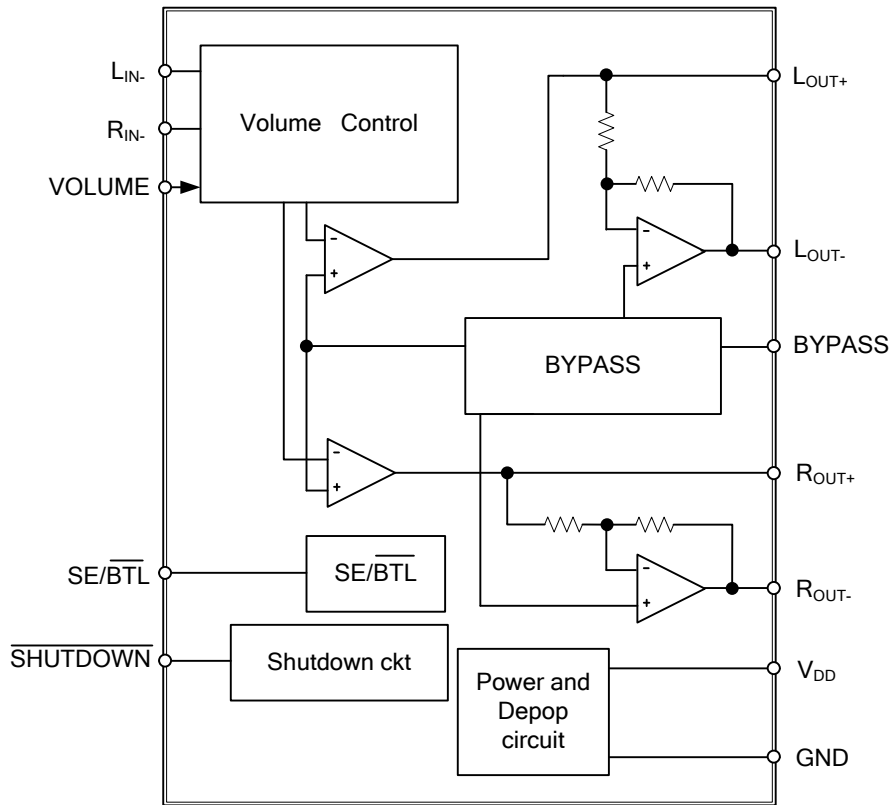

### ■ ABSOLUTE MAXIMUM RATINGS

(Over operating free-air temperature range unless otherwise specified)

PARAMETER	SYMBOL	RATINGS	UNIT
Supply Voltage	$V_{DD}$	-0.3 ~ 6	V
Input Voltage , SE/BTL, SHUTDOWN	$V_{IN}$	-0.3 ~ $V_{DD}+0.3$	V
Power Dissipation	$P_D$	Internal Limited	
Junction Temperature	$T_J$	Internal Limited(Note1)	°C
Operating Temperature	$T_{OPR}$	-40 ~ 85	°C
Storage Temperature	$T_{STG}$	-65~ +150	°C

Note: 1. That integrated internal thermal shutdown protection when junction temperature ramp up to 150°C

2. Absolute maximum ratings are those values beyond which the device could be permanently damaged.

Absolute maximum ratings are stress ratings only and functional device operation is not implied.

### ■ THERMAL DATA

PARAMETER	SYMBOL	RATINGS	UNIT
Junction to Ambient in Free Air	$\theta_{JA}$	45	°C/W

### ■ OPERATING CONDITIONS RECOMMENDED

PARAMETER	SYMBOL	MIN	TYP	MAX	UNI
Supply Voltage	$V_{DD}$	4.5		5.5	V
High Level Threshold Voltage	SHUTDOWN	2			V
	SE/BTL	4			V
Low Level Threshold Voltage	SHUTDOWN			1.0	V
	SE/BTL			3	V
Common Mode Input Voltage	$V_{(ICM)}$	$V_{DD}-1.0$			V

### ■ ELECTRICAL CHARACTERISTICS $V_{DD}=5V$ , $-20^{\circ}C < T_A < 85^{\circ}C$ (unless otherwise specified)

PARAMETER	SYMBOL	TEST CONDITIONS	MIN	TYP	MAX	UNIT
Supply Voltage	$V_{DD}$		4.5		5.5	V
Supply Current	$I_{DD}$	SE/BTL=0V		9	20	mA
		SE/BTL=5V		4	10	mA
Supply Current in Shutdown Mode	$I_{SD}$	SE/BTL=0V SHUTDOWN=0V		1		μA
input Current	High	$I_{IH}$		900		nA
	Low	$I_{IL}$		900		nA
Output Differential Voltage	$V_{OS}$			5		mV
<b>BTL Mode <math>V_{DD}=5V</math>, <math>T_A=25^{\circ}C</math>, <math>R_L=4\Omega</math>, Gain=2dB</b>						
Maximum Output Power	$P_{OUT}$	THD=10%, $R_L=3\Omega$ , $F_{IN}=1kHz$		2.9		W
		THD=10%, $R_L=4\Omega$ , $F_{IN}=1kHz$		2.6		W
		THD=10%, $R_L=8\Omega$ , $F_{IN}=1kHz$		1.6		W
		THD=1%, $R_L=3\Omega$ , $F_{IN}=1kHz$		2.4		W
		THD=1%, $R_L=4\Omega$ , $F_{IN}=1kHz$		1.8		W
		THD=0.5%, $R_L=8\Omega$ , $F_{IN}=1kHz$	1	1.3		W
Total Harmonic Distortion Plus Noise	THD+N	$P_{OUT}=1.2W$ , $R_L=4\Omega$ , $F_{IN}=1kHz$		0.07		%
		$P_{OUT}=0.9W$ , $R_L=8\Omega$ , $F_{IN}=1kHz$		0.08		%
Power Ripple Rejection Ratio(Note1)	PSRR	$V_{IN}=0.1V_{rms}$ , $R_L=8\Omega$ , $C_B=1\mu F$ , $F_{IN}=120Hz$		60		dB
Channel Separation	Xtalk	$C_B=1mF$ , $R_L=8\Omega$ , $F_{IN}=1kHz$		90		dB
Signal to Noise Ratio	S/N	$P_{OUT}=1.1W$ , $R_L=8\Omega$ , A_wieght		95		dB

■ ELECTRICAL CHARACTERISTICS(Cont.)

PARAMETER	SYMBOL	TEST CONDITIONS	MIN	TYP	MAX	UNIT
<b>SE Mode</b> $V_{DD}=5V, T_A=25^{\circ}C, \text{Gain}=1dB$						
Maximum Output Power	$P_{OUT}$	THD=10%, $R_L=16\Omega, F_{IN}=1kHz$		220		mW
		THD=10%, $R_L=32\Omega, F_{IN}=1kHz$		120		mW
		THD=1%, $R_L=16\Omega, F_{IN}=1kHz$		160		mW
		THD=1%, $R_L=32\Omega, F_{IN}=1kHz$		95		mW
Total Harmonic Distortion Plus Noise	THD+N	$P_{OUT}=125mW, R_L=16\Omega, F_{IN}=1kHz$		0.09		%
		$P_{OUT}=65mW, R_L=32\Omega, F_{IN}=1kHz$		0.09		
Power Ripple Rejection Ratio	PSRR	$V_{IN}=0.1V_{rms}, R_L=8\Omega, C_B=1\mu F, F_{IN}=120Hz$		60		dB
Channel Separation	Xtalk	$C_B=1mF, R_L=32\Omega, F_{IN}=1kHz$		60		dB
Signal to Noise Ratio	S/N	$P_{OUT}=75mW, SE, R_L=32\Omega, A_{wiegth}$		100		dB

## ■ TYPICAL APPLICATION CIRCUIT

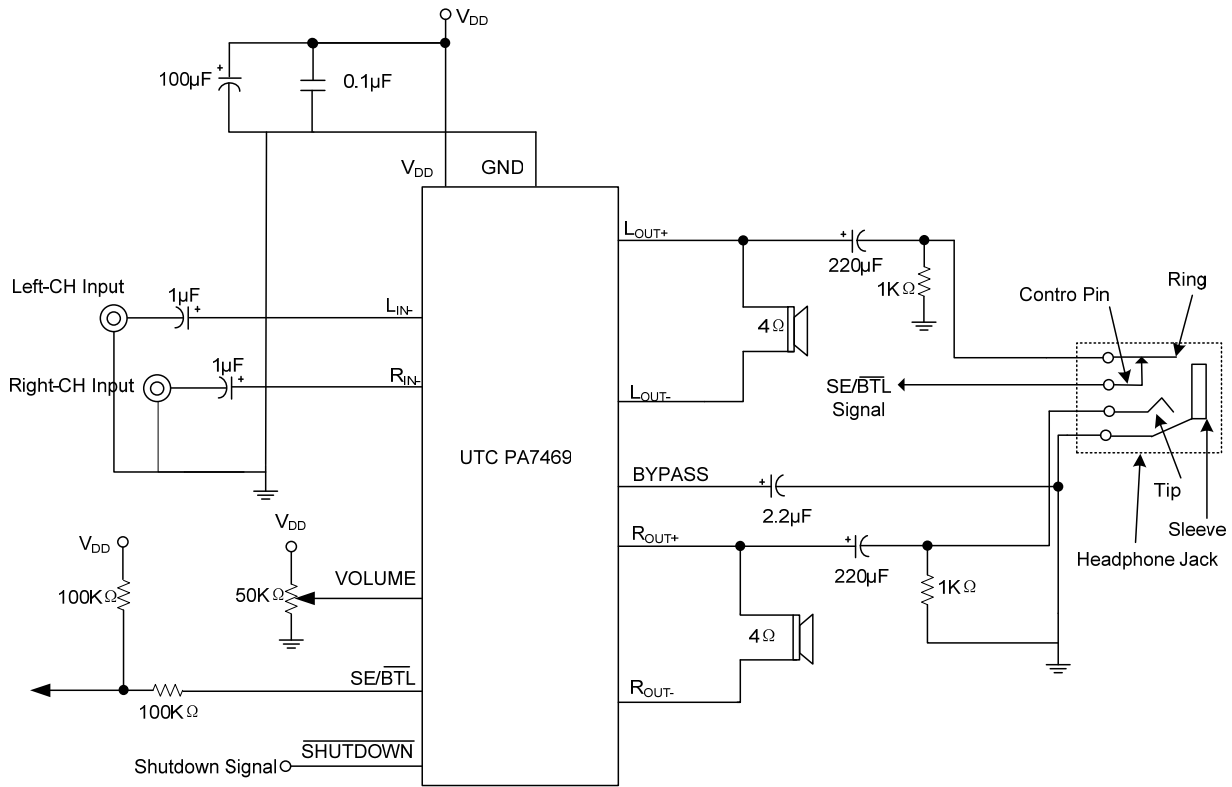

■ VOLUME CONTROL TABLE\_BTL MODE (Supply Voltage  $V_{DD}=5V$ )

GAIN(DB)	HIGH(V)	LOW(V)	HYSTERESIS(MV)	RECOMMENDED VOLTAGE(V)
20	0.12	0.00		0
18	0.23	0.17	52	0.20
16	0.34	0.28	51	0.31
14	0.46	0.39	50	0.43
12	0.57	0.51	49	0.54
10	0.69	0.62	47	0.65
8	0.80	0.73	46	0.77
6	0.91	0.84	45	0.88
4	1.03	0.96	44	0.99
2	1.14	1.07	43	1.10
0	1.25	1.18	41	1.22
-2	1.37	1.29	40	1.33
-4	1.48	1.41	39	1.44
-6	1.59	1.52	38	1.56
-8	1.71	1.63	37	1.67
-10	1.82	1.74	35	1.78
-12	1.93	1.85	34	1.89
-14	2.05	1.97	33	2.01
-16	2.16	2.08	32	2.12
-18	2.28	2.19	30	2.23
-20	2.39	2.30	29	2.35
-22	2.50	2.42	28	2.46
-24	2.62	2.53	27	2.57
-26	2.73	2.64	26	2.69
-28	2.84	2.75	24	2.80
-30	2.96	2.87	23	2.91
-32	3.07	2.98	22	3.02
-34	3.18	3.09	21	3.14
-36	3.30	3.20	20	3.25
-38	3.41	3.32	18	3.36
-40	3.52	3.43	17	3.48
-80	5.00	3.54	16	5

■ TYPICAL CHARACTERISTICS

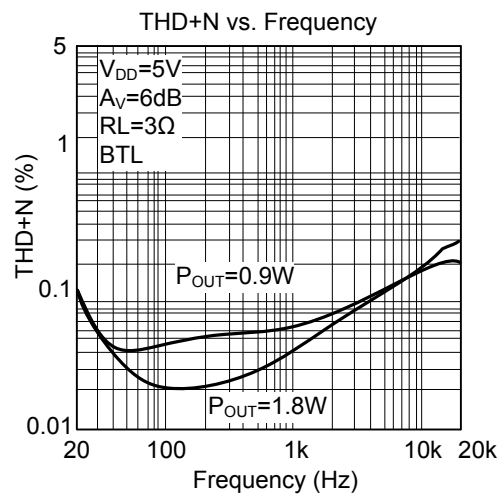
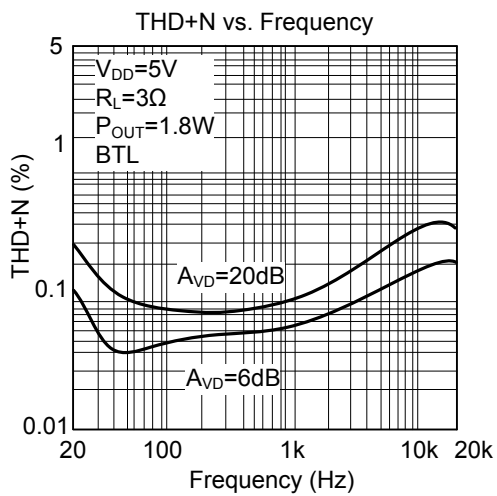
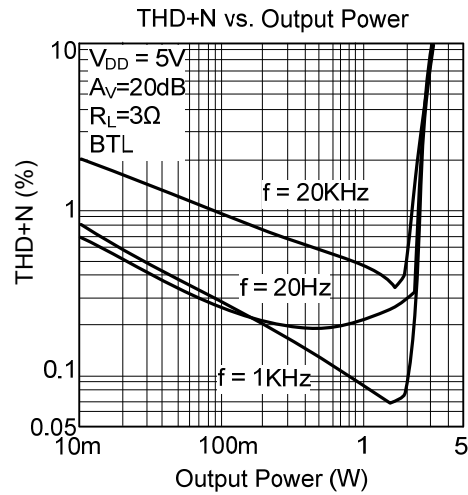
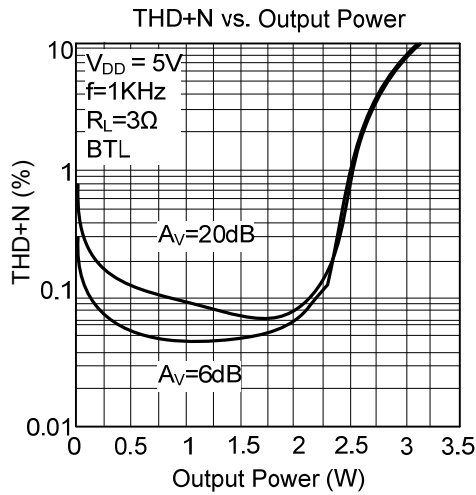
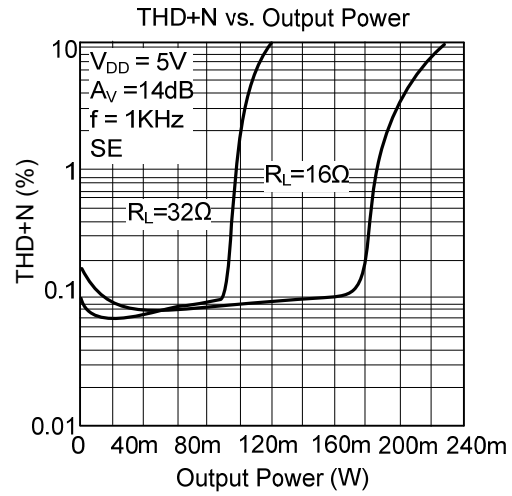
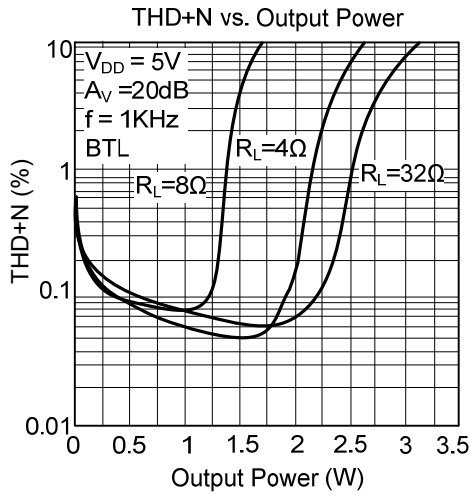



■ TYPICAL CHARACTERISTICS

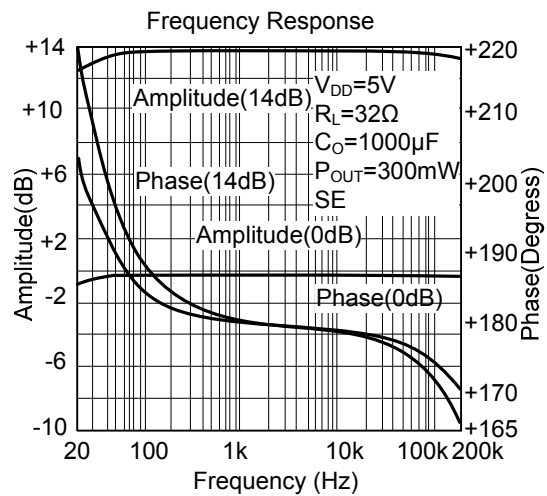
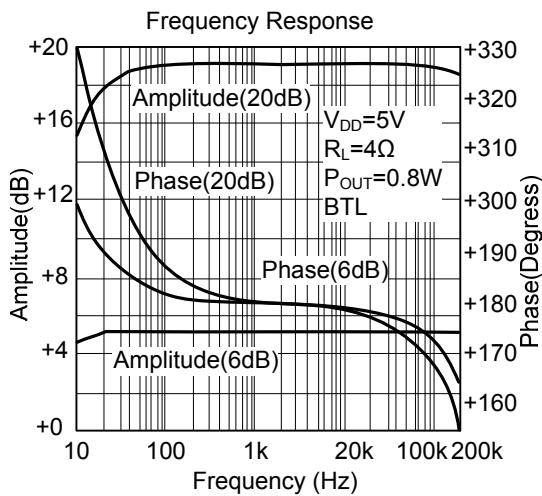
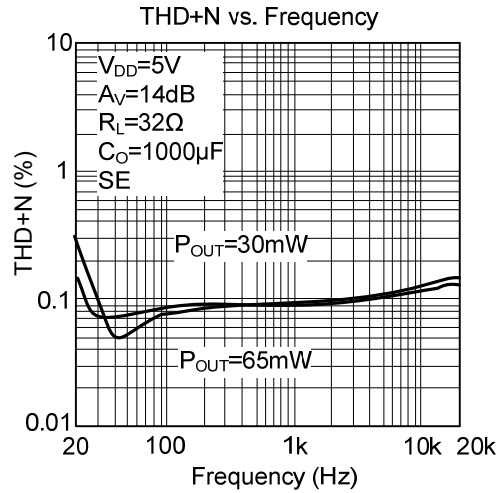
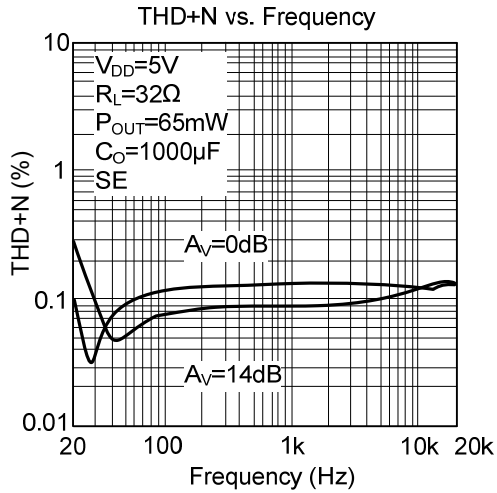
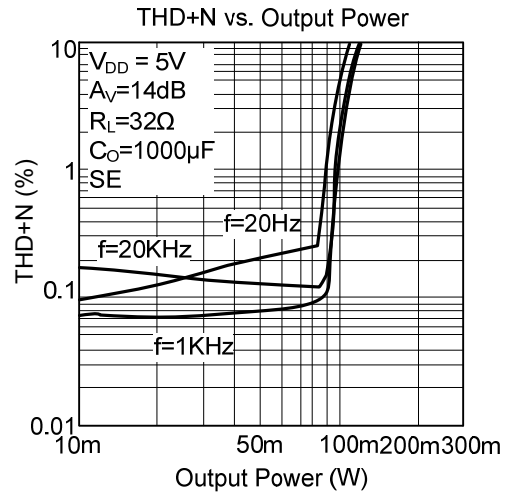
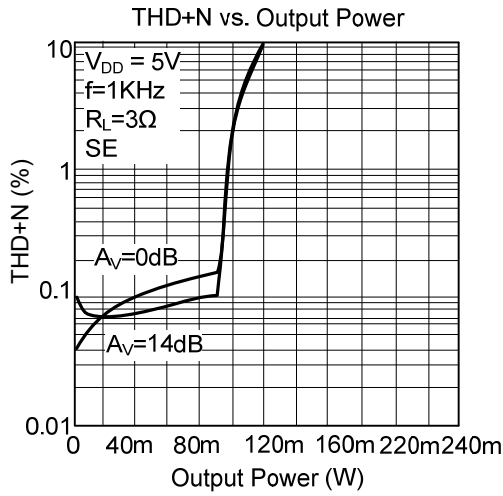

■ TYPICAL CHARACTERISTICS(Cont.)

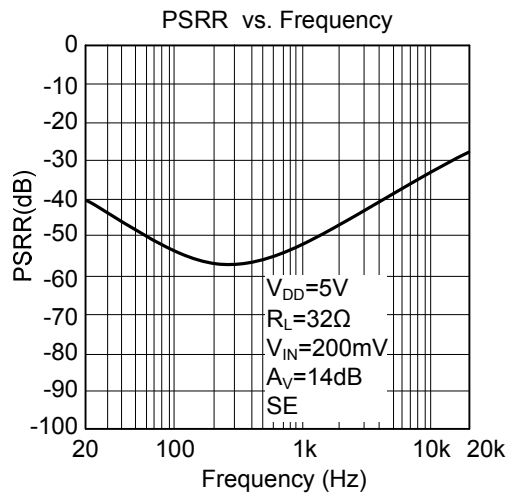
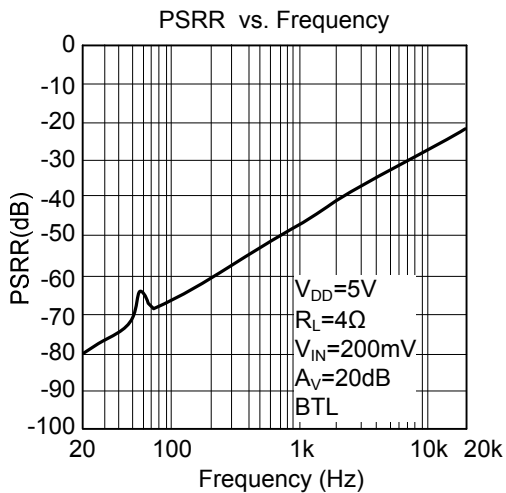
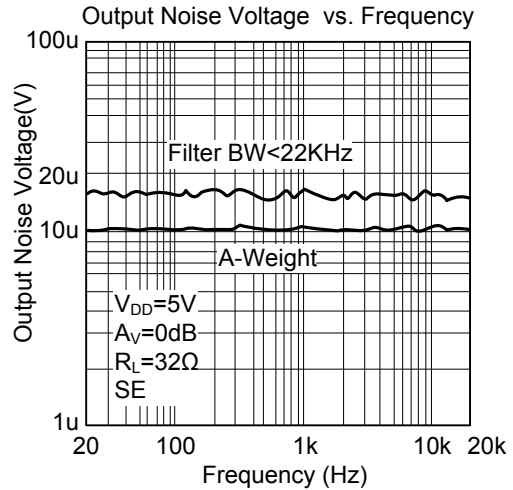
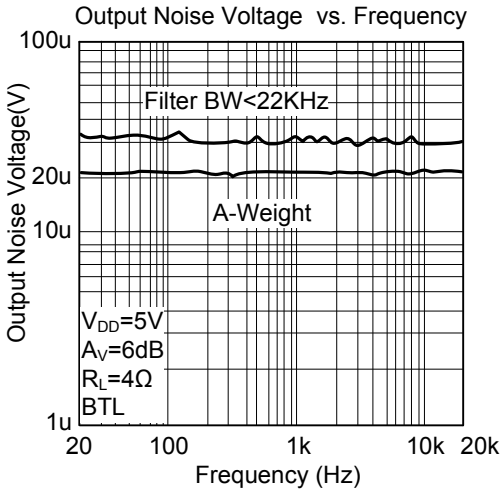
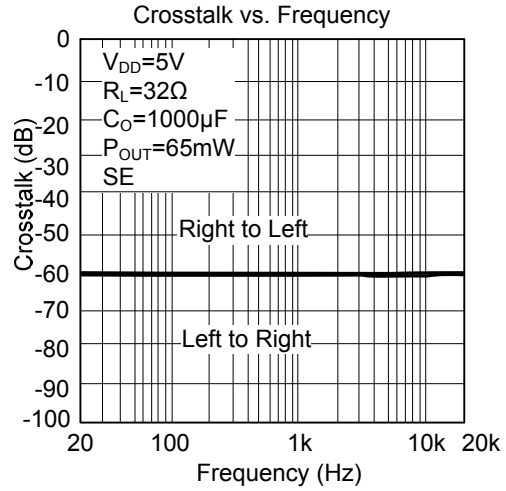
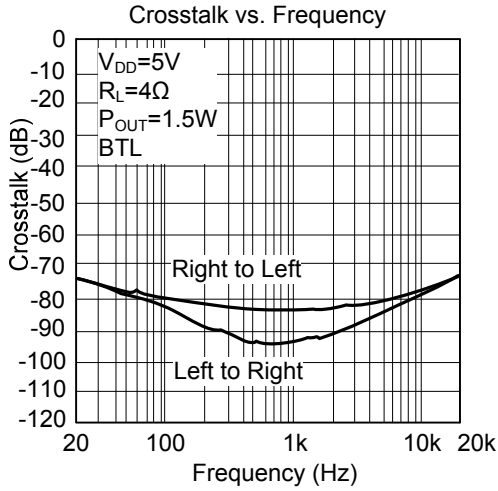

■ TYPICAL CHARACTERISTICS(Cont.)

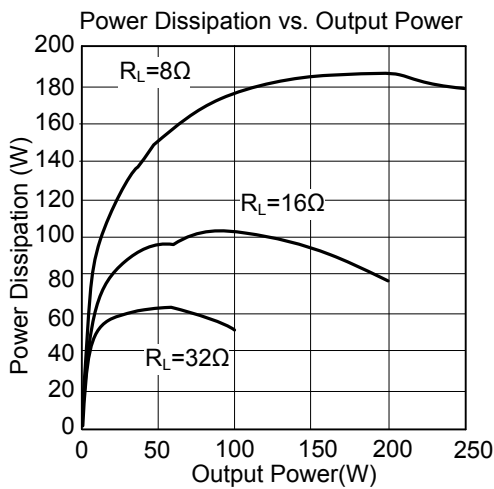
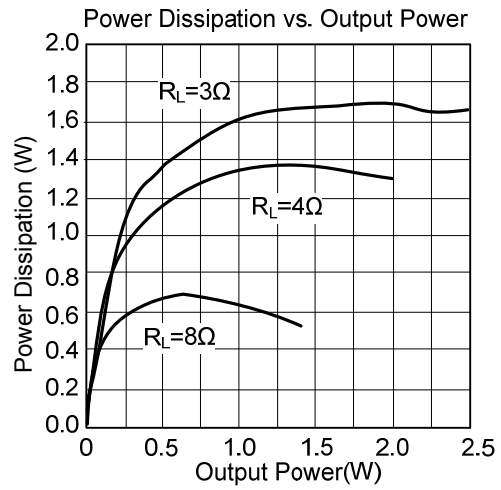
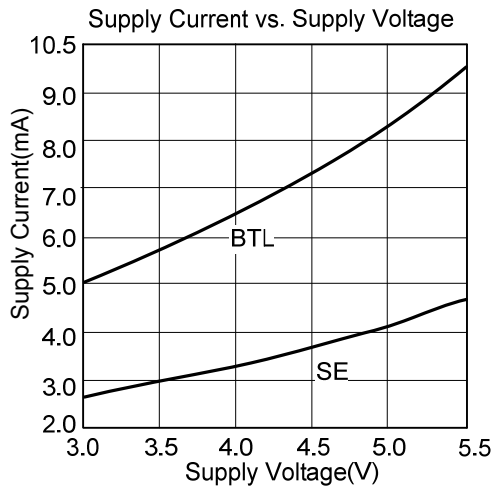
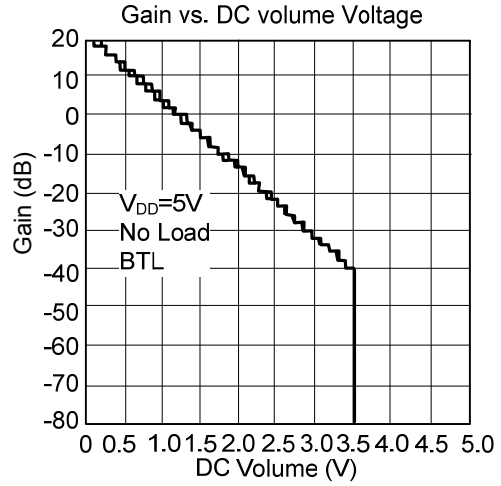
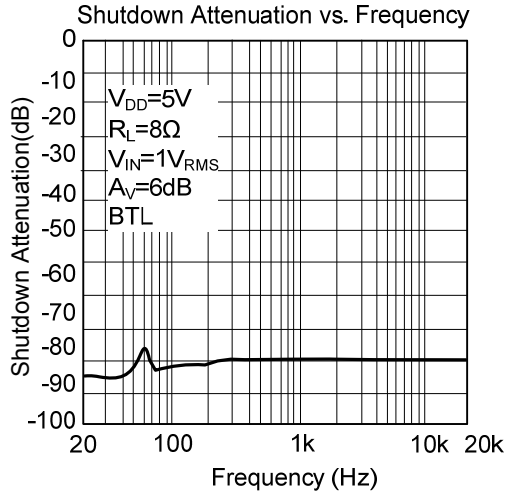

UTC assumes no responsibility for equipment failures that result from using products at values that exceed, even momentarily, rated values (such as maximum ratings, operating condition ranges, or other parameters) listed in products specifications of any and all UTC products described or contained herein. UTC products are not designed for use in life support appliances, devices or systems where malfunction of these products can be reasonably expected to result in personal injury. Reproduction in whole or in part is prohibited without the prior written consent of the copyright owner. The information presented in this document does not form part of any quotation or contract, is believed to be accurate and reliable and may be changed without notice.