

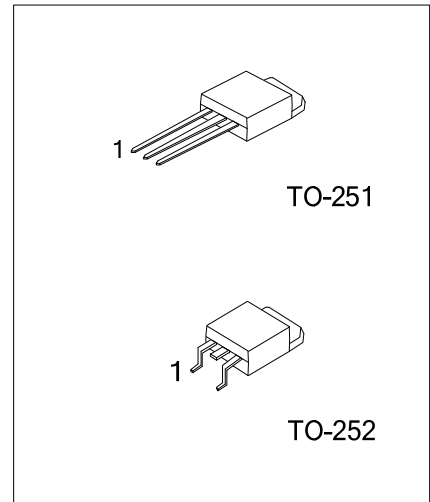

SB2202

PNP EPITAXIAL SILICON TRANSISTOR

MEDIUM POWER LOW VOLTAGE TRANSISTOR



■ **DESCRIPTION**

The UTC **SB2202** is a medium power low voltage transistor, designed for audio power amplifier, DC-DC converter and voltage regulator.

■ **FEATURES**

- *High current output up to 3A
- *Low saturation voltage

■ **ORDERING INFORMATION**

Ordering Number		Package	Pin Assignment			Packing
Lead Free	Halogen Free		1	2	3	
SB2202L-x-TM3-T	SB2202G-x-TM3-T	TO-251	B	C	E	Tube
SB2202L-x-TN3-T	SB2202G-x-TN3-T	TO-252	B	C	E	Tube
SB2202L-x-TN3-R	SB2202G-x-TN3-R	TO-252	B	C	E	Tape Reel

Note: Pin Assignment: B: Base C: Collector E: Emitter

<p>SB2202G-x-TM3-R</p>	<p>(1) T: Tube, R: Tape Reel</p> <p>(2) TM3: TO-251, TN3: TO-252</p> <p>(3) x: refer to Classification of h_{FE2}</p> <p>(4) G: Halogen Free and Lead Free, L: Lead Free</p>
------------------------	---

■ **MARKING**

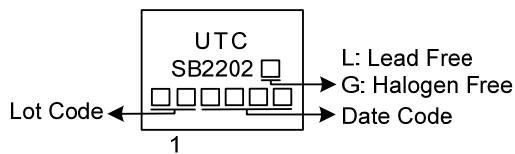

■ ABSOLUTE MAXIMUM RATINGS ($T_A=25^\circ\text{C}$, unless otherwise specified)

PARAMETER		SYMBOL	RATINGS	UNIT
Collector-Base Voltage		V_{CBO}	-40	V
Collector-Emitter Voltage		V_{CEO}	-30	V
Emitter-Base Voltage		V_{EBO}	-5	V
Base Current		I_B	-0.6	A
Collector Current	DC	I_C	-3	A
	PULSE	I_{CM}	-7	
Collector Dissipation	$T_A=25^\circ\text{C}$	P_C	1	W
	$T_C=25^\circ\text{C}$		10	
Junction Temperature		T_J	+150	$^\circ\text{C}$
Storage Temperature		T_{STG}	-40 ~ +150	$^\circ\text{C}$

■ ELECTRICAL CHARACTERISTICS ($T_A=25^\circ\text{C}$, unless otherwise specified.)

PARAMETER	SYMBOL	TEST CONDITIONS	MIN	TYP	MAX	UNIT
Collector-Emitter Saturation Voltage	$V_{CE(sat)}$	$I_C = -2A, I_B = -0.2A$		-0.3	-0.5	V
Base-Emitter Saturation Voltage	$V_{BE(sat)}$	$I_C = -2A, I_B = -0.2A$		-1.0	-2.0	V
Collector Cut-Off Current	I_{CBO}	$V_{CB} = -30V, I_E = 0$			1	mA
Emitter Cut-Off Current	I_{EBO}	$V_{EB} = -3V, I_C = 0$			1	mA
DC Current Gain(Note 1)	h_{FE1}	$V_{CE} = -2V, I_C = -20mA$	30	200		
	h_{FE2}	$V_{CE} = -2V, I_C = -1A$	100		400	
Current Gain Bandwidth Product	f_T	$V_{CE} = -5V, I_C = -0.1A$		80		MHz
Output Capacitance	C_{ob}	$V_{CB} = -10V, I_E = 0, f = 1MHz$		45		pF

Note 1: Pulse test: $PW < 300\mu s$, Duty Cycle $< 2\%$

■ CLASSIFICATION OF h_{FE2}

RANK	Q	P	E
RANGE	100 ~ 200	160 ~ 320	200 ~ 400

■ TYPICAL CHARACTERISTICS

Static characteristics

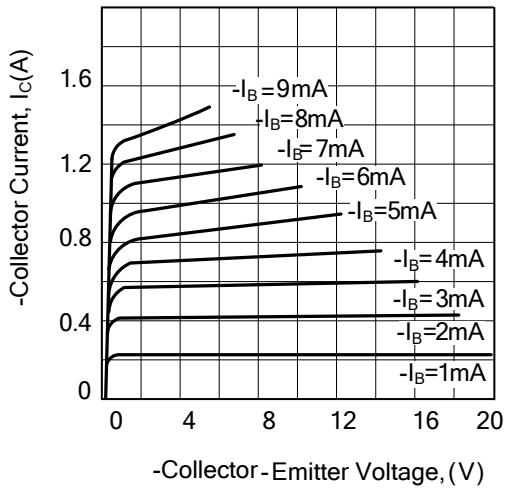

Derating curve of safe operating areas

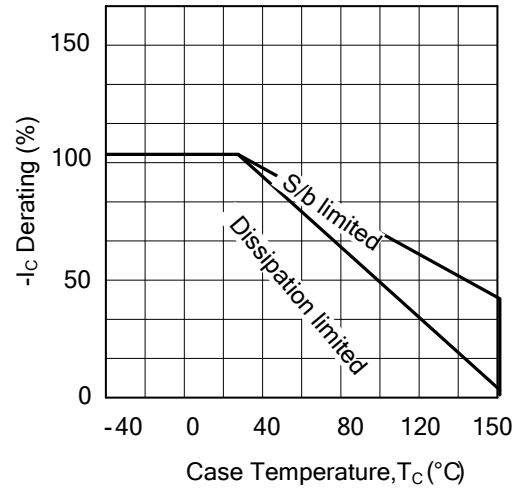

Power derating

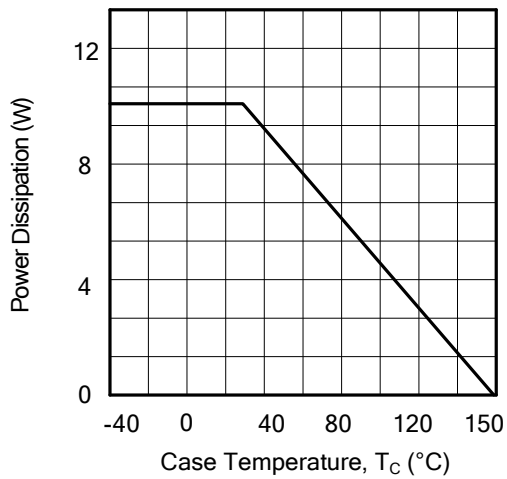

Collector output capacitance

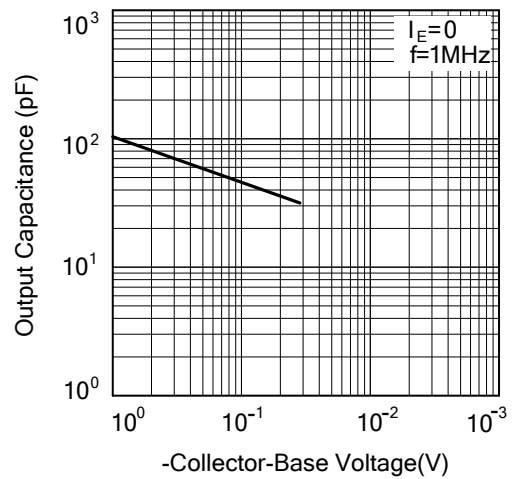

Current gain-bandwidth product

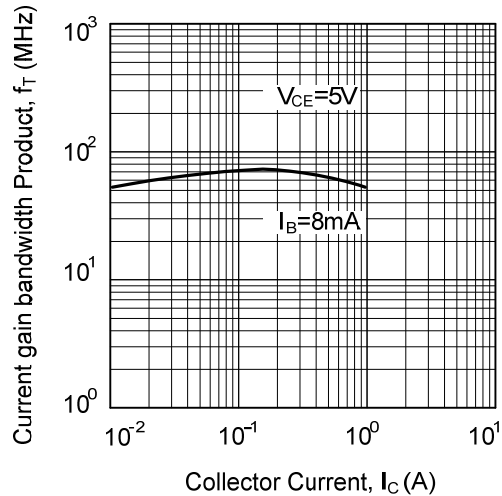

Safe operating area

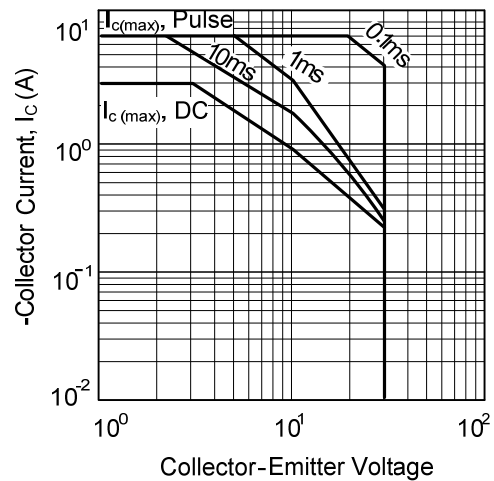

■ TYPICAL CHARACTERISTICS (Cont.)

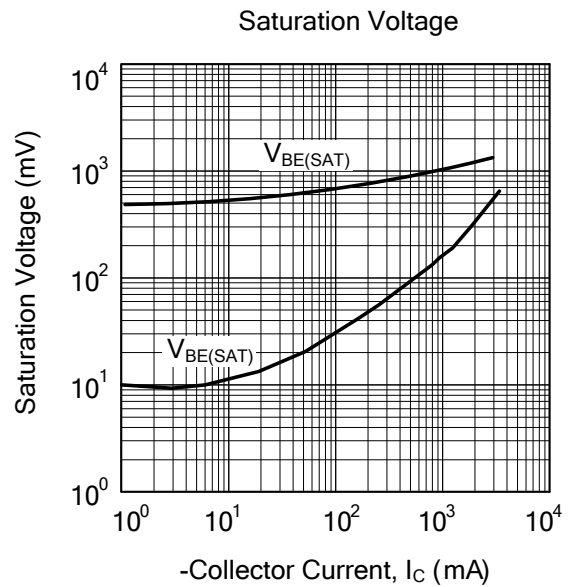
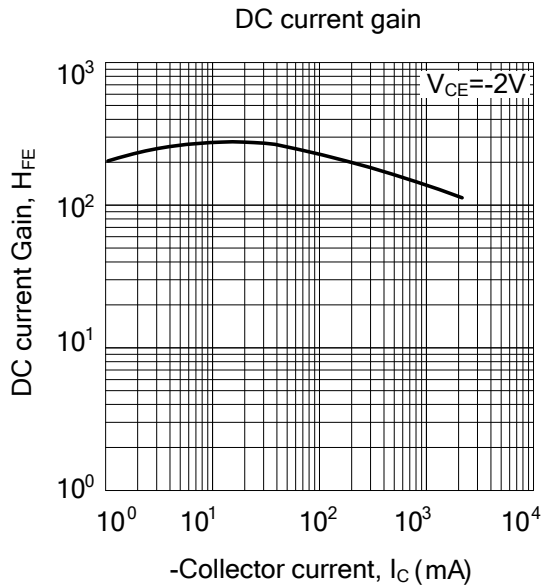

UTC assumes no responsibility for equipment failures that result from using products at values that exceed, even momentarily, rated values (such as maximum ratings, operating condition ranges, or other parameters) listed in products specifications of any and all UTC products described or contained herein. UTC products are not designed for use in life support appliances, devices or systems where malfunction of these products can be reasonably expected to result in personal injury. Reproduction in whole or in part is prohibited without the prior written consent of the copyright owner. UTC reserves the right to make changes to information published in this document, including without limitation specifications and product descriptions, at any time and without notice. This document supersedes and replaces all information supplied prior to the publication hereof.