



TA8207K

LINEAR INTEGRATED CIRCUIT

LOW FREQUENCY POWER AMPLIFIER

DESCRIPTION

The UTC **TA8207K** is an audio power IC with built-in two channels and thermal shut down protection circuit.

The IC is developed for portable radio cassette tape recorder with power ON/OFF switch.

FEATURES

- *High Power : $P_{OUT}=2.5W / CH$ (Typ.)
($V_{CC}=9V, R_L=4\Omega, f=1KHz, THD=10\%$)
: $P_{OUT}=4.6W / CH$ (Typ.)
($V_{CC}=12V, R_L=4\Omega, f=1KHz, THD=10\%$)
- *Low Popping Noise at Power ON
- *Small Quiescent Current: $IC_{CQ}=21mA$ (Typ.)
($V_{CC}=9V, V_{IN}=0$)
- *Soft Clip
- *Built-in Thermal Shut Down Protection Circuit
- *Best for Supply Voltage 9V, 12V
- *Operation Supply Voltage Range: $V_{CC}=6-15V$

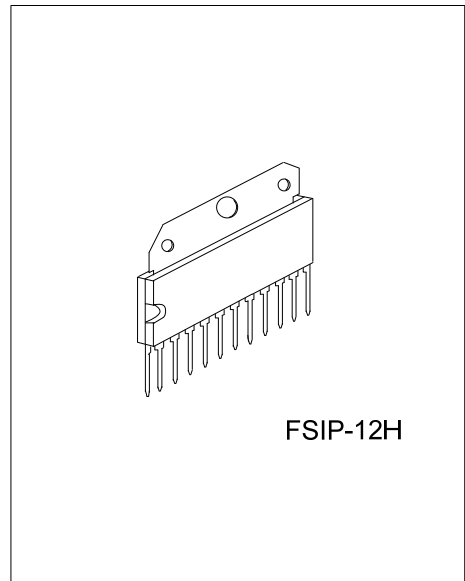

ORDERING INFORMATION

Order Number		Package	Packing
Lead Free	Halogen Free		
TA8207KL-F12-H-T	TA8207KL-F12-H-T	FSIP-12H	Tube

<p>TA8207KL-F12-H-T</p> <p>(1)Packing Type (2)Package Type (3)Green Package</p>	<p>(1) T: Tube (2) F12-H: FSIP-12H (3) L: Lead Free, G: Halogen Free and Lead Free</p>
---	--

MARKING

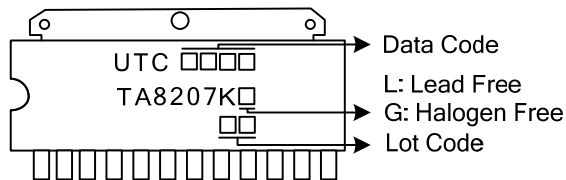

■ PIN CONFIGURATION

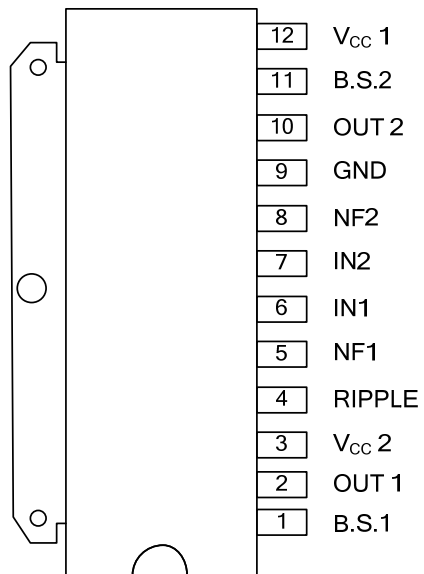

■ ABSOLUTE MAXIMUM RATINGS ($T_A=25^{\circ}\text{C}$, unless otherwise specified)

PARAMETER	SYMBOL	VALUE	UNIT
Supply Voltage	V_{CC}	20	V
Output Current (Peak / CH)	$I_{O(PEAK)}$	2.5	A
Power Dissipation	P_D	12.5	W
Operating Temperature	T_{OPR}	-20 ~ + 75	$^{\circ}\text{C}$
Storage Temperature	T_{STG}	-55 ~ + 150	$^{\circ}\text{C}$

■ ELECTRICAL CHARACTERISTICS

($V_{CC}=9\text{V}$, $R_L=4\Omega$, $R_G=600\Omega$, $f=1\text{kHz}$, $T_A=25^{\circ}\text{C}$, unless otherwise specified)

PARAMETER	SYMBOL	TEST CONDITIONS	MIN	TYP	MAX	UNIT
Quiescent Current	I_{CCQ}	$V_{IN}=0$		21	45	mA
Output Power	$P_{OUT(1)}$	THD=10%	2.0	2.5		W
	$P_{OUT(2)}$	$V_{CC}=12\text{V}$, THD=10%		4.6		W
Total Harmonic Distortion	THD	$P_{OUT}=0.4\text{W} / \text{ch}$		0.2	1.0	%
Output Noise Voltage	e_N	$R_G=10\text{k}\Omega$, $B_W=20\text{Hz} \sim 20\text{kHz}$		0.3	1.0	mV_{RMS}
Input Resistance	R_{IN}			30		$\text{k}\Omega$
Voltage Gain	$G_V(1)$	$R_F=120\Omega$ $V_{OUT}=0.775V_{RMS}$	43	45	47	dB
	$G_V(2)$	$R_F=0$, $V_{OUT}=0.775V_{RMS}$		56.5		dB
Ripple Rejection Ratio	RR	$R_G=600\Omega$ Fripple=100Hz		52		dB
Cross Talk	C_T	$R_G=600\Omega$, Amp1 \leftrightarrow 2 $V_{OUT}=0\text{dBm}$, $f=1\text{kHz}$		50		dB
Input Offset Voltage	V_6, V_7			30	60	mV
Stand-by Current	ISTDBY	SW1 \rightarrow OFF		1		μA

■ TYPICAL DC VOLTAGE OF EACH TERMINAL ($V_{CC}=9\text{V}$, $T_A=25^{\circ}\text{C}$, unless otherwise specified)

TERMINAL NO.	1	2	3	4	5	6	7	8	9	10	11	12
DC Voltage	8.7	4.5	V_{CC}	5.0	0.7	0.03	0.03	0.7	GND	4.5	8.7	V_{CC}

■ TEST CIRCUIT

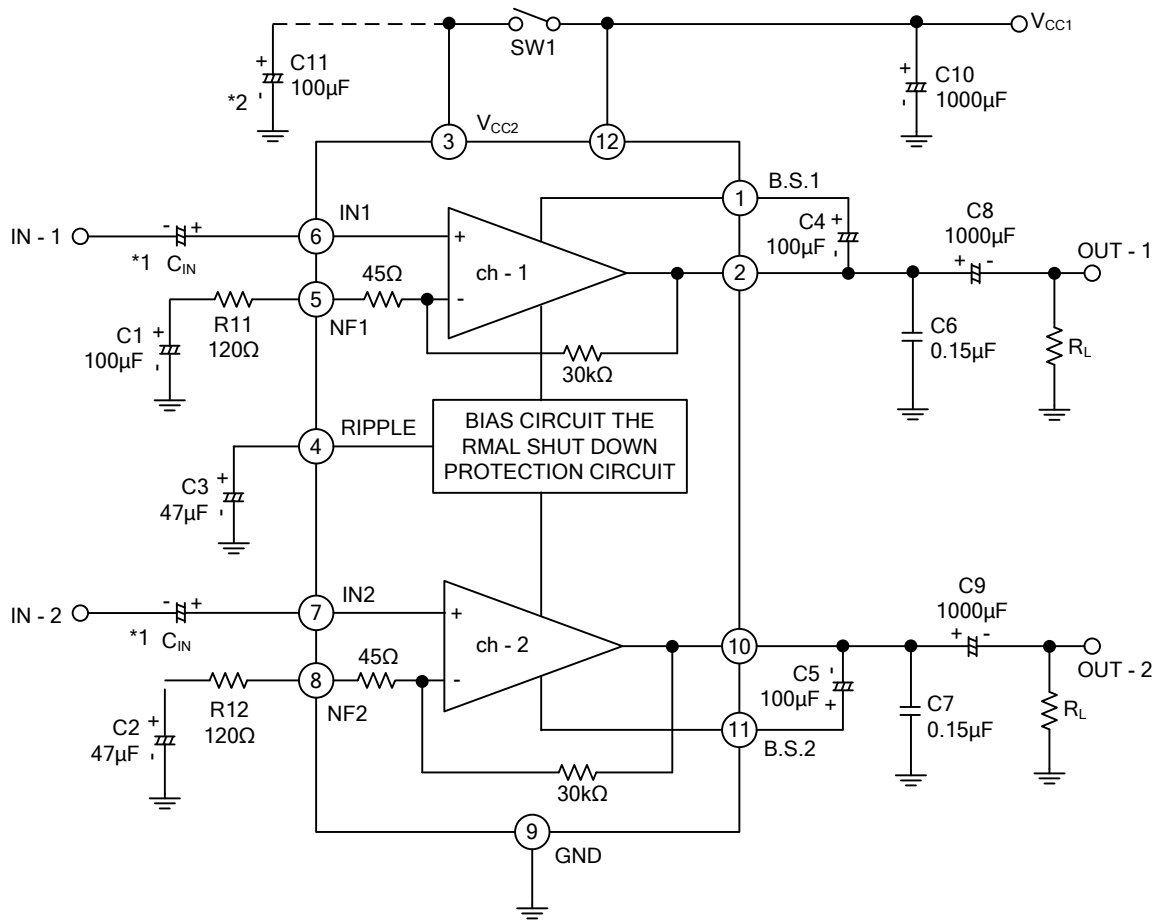

- REMARK: 1.This IC can be used without coupling capacitor (C_{IN}). If volume slide noise occurred by input offset voltage is undesirable, it needs to use the capacitor (C_{IN}).
- 2.The condenser between the pin3 and the GND (C_{11}) is for reducing pop noise when the power ON/OFF switch (SW1) is set to ON/OFF.

APPLICATION INFORMATION

1. ADJUSTMENT OF VOLTAGE GAIN

The voltage gain G_V is obtained as follows by R_1 , R_2 and R_F in Fig.1.

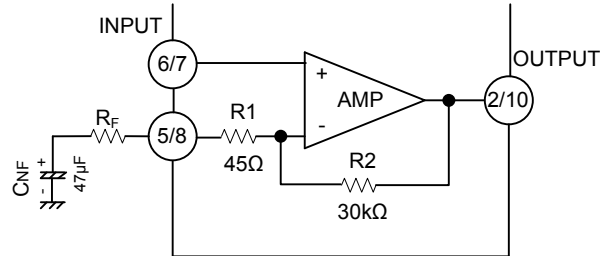

$$G_V = 20 \log \frac{R_F + R_1 + R_2}{R_F + R_1}$$

When $R_F = 0\Omega$ $G_V = 56.5\text{dB (typ.)}$

When $R_F = 120\Omega$ $G_V = 45\text{dB (typ.)}$

Reduction of G_V is possible by increasing R_F . However, it is recommended to use this at 40dB or over since the feedback increase is liable to produce oscillation.

2. THERMAL SHUTDOWN CIRCUIT

The built-in thermal shut-down circuit can prevent the destruction of IC that abnormal temperature rise when the heat radiation is insufficient. The operation temperature is set at radiation fin temperature 175°C , at this temperature or over the bias is interrupted to prevent the destruction of IC.

3. INPUT STAGE

Below circuit shows the input circuit of this IC.

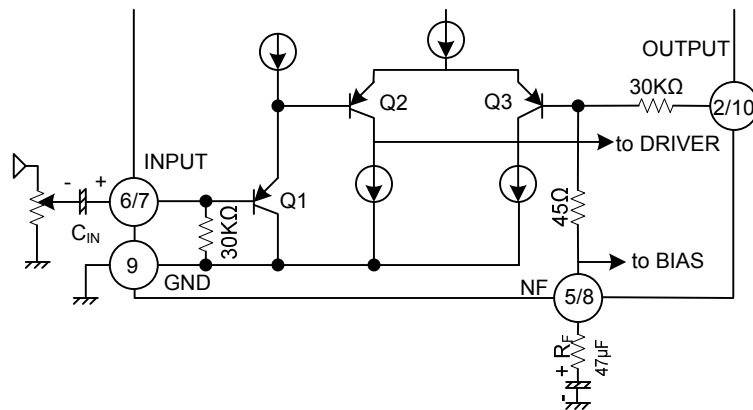

It is possible that without input coupling capacitor in the input circuit by use a PNP Transistor, Q1. However, 60mV max offset voltage is produced at pin (6) and (7). Application after checking volume slide noise is recommended. In order to cut the volume slide noise, insert the input capacitor (C_{IN}) in series to interrupt the DC component.

■ APPLICATION INFORMATION(Cont.)

4. OSCILLATION PREVENTIVE MEASURES

For oscillation preventive capacitor C6 and C7 between the output terminal and GND, polyester film capacitor is recommended due to good characteristics for temperature and for high frequency. It is better that use this capacitor after the temperature test to check the oscillation allowance due to the characteristics of the capacitor is liable to be influenced by the temperature. Besides, as the position of the electrolytic capacitor has remarkable influence on the oscillation, connect C10 to V_{CC} as close power GND as possible.

At using this application with the voltage gain reduced, oscillation is liable to be produced. Apply the capacitor after checking enough for its capacity, type and mounting position.

5. POWER ON/OFF SWITCH

There is power on/off switch at (3) pin. However, output power is changed by (3) pin supply voltage when(3) pin supply voltage I not same(12) pin supply voltage, after referring to attached date, select(3) pin supply voltage.

6. INPUT VOLTAGE

When the excessive signal is input, turning-up is produced in the clip waveform. The turning-up point is $V_{IN}=300mV_{RMS}$ (typ.): $V_{CC}=9V$, $R_L=4\Omega$, $f=1kHz$: Enough care must be taken for this phenomenon.

7. GND LINE

GND pin is not separated for pre-GND and for P_W -GND. That is liable to cause distortion and cross talk worse.

TYPICAL CHARACTERISTICS

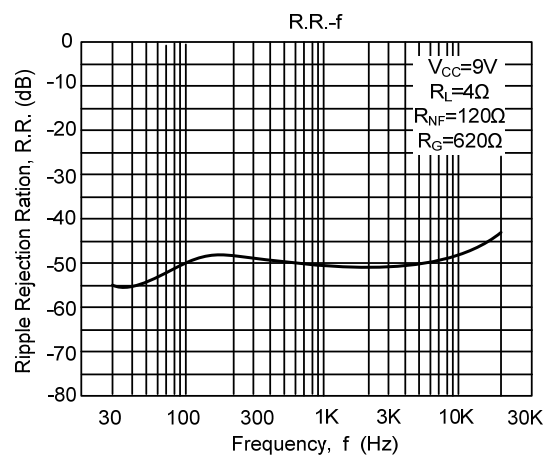
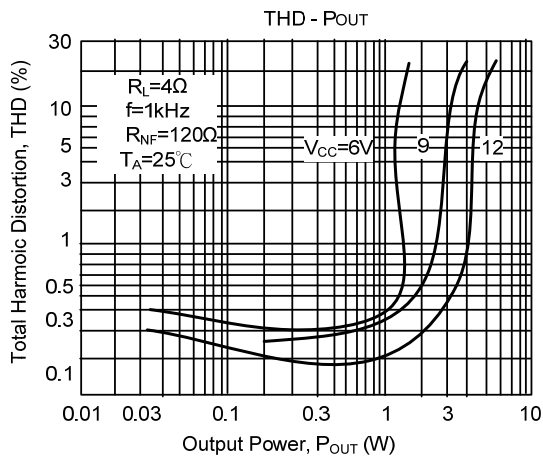
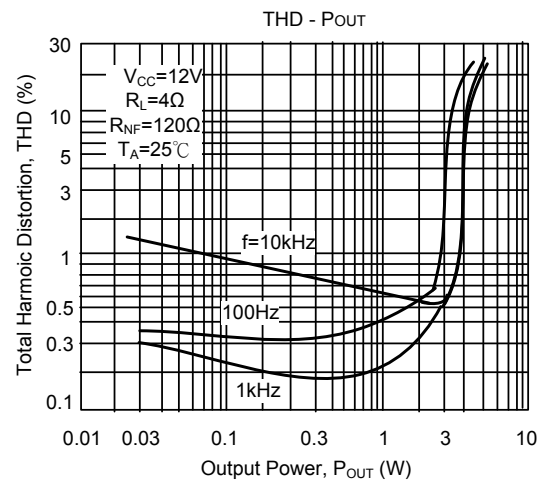
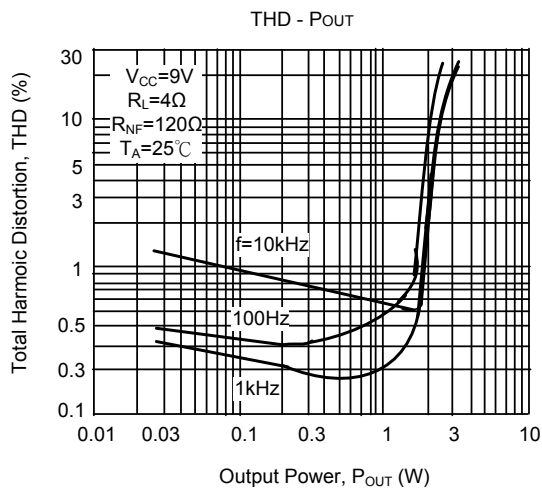
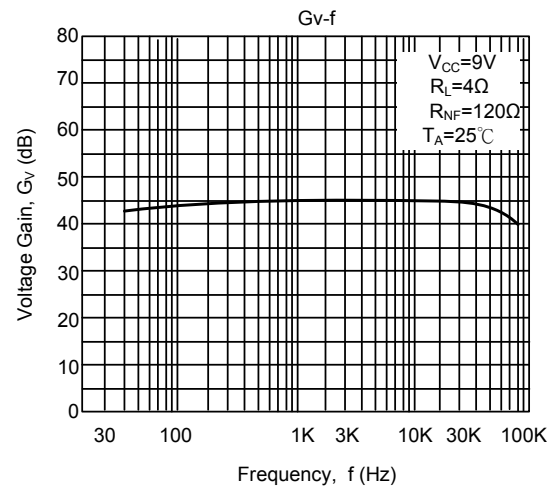
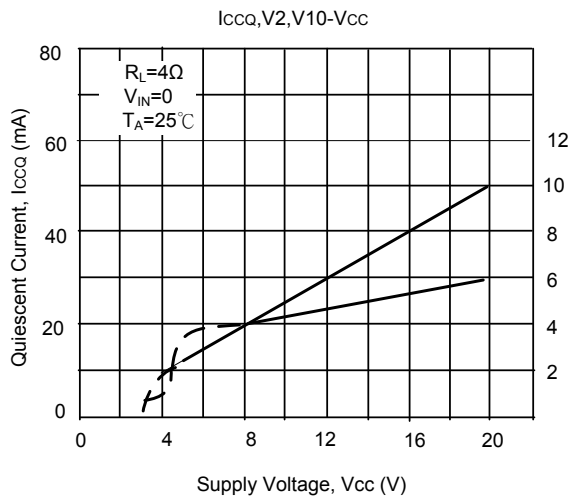

TYPICAL CHARACTERISTICS (Cont.)

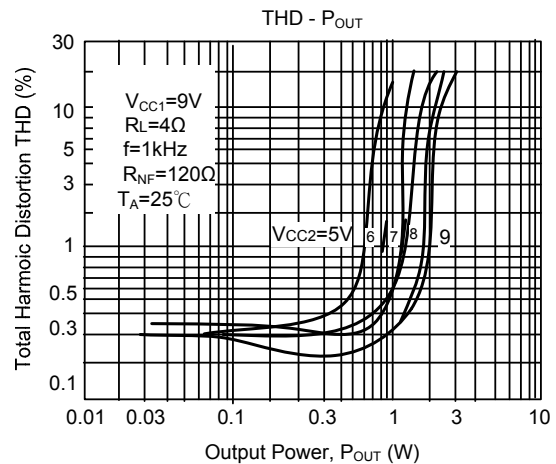
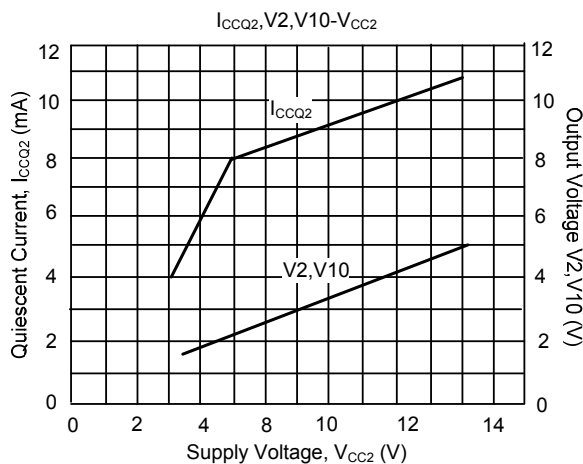
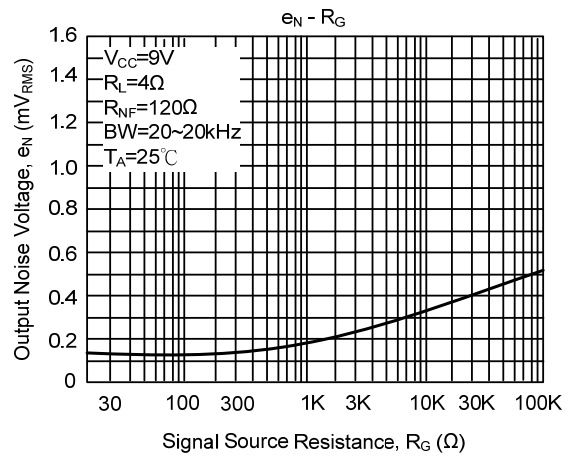
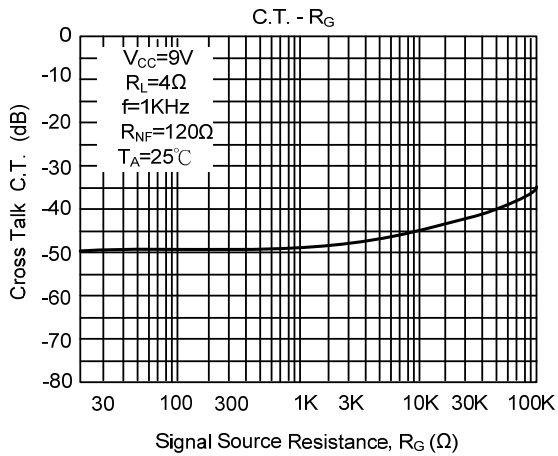
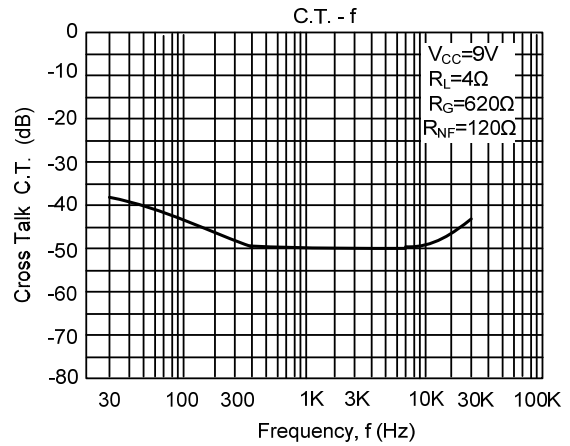
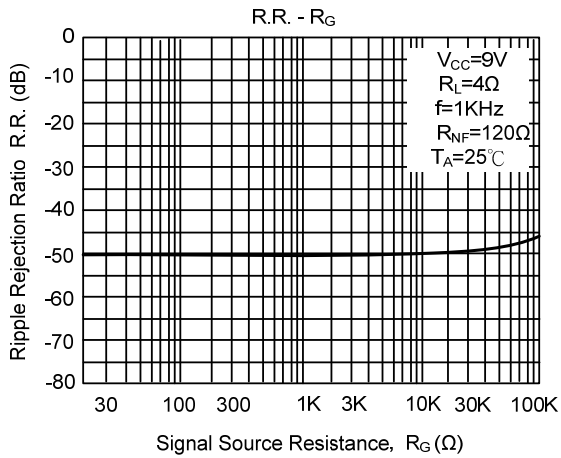

TYPICAL CHARACTERISTICS (Cont.)

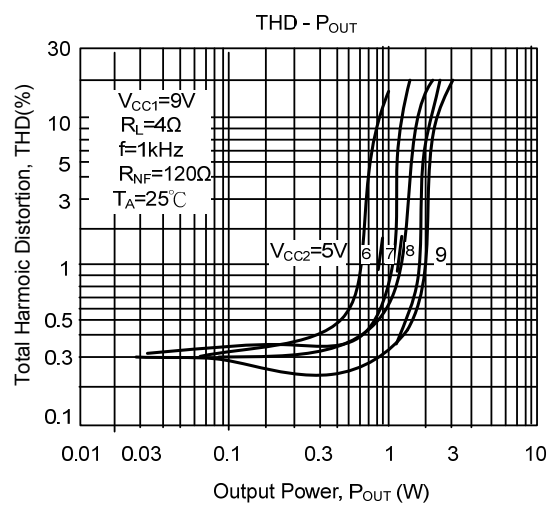
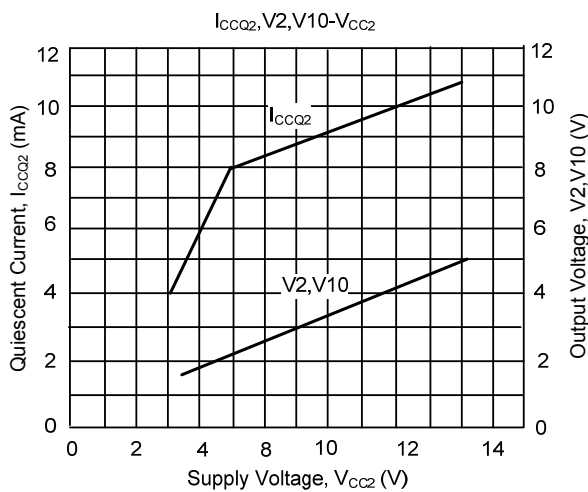
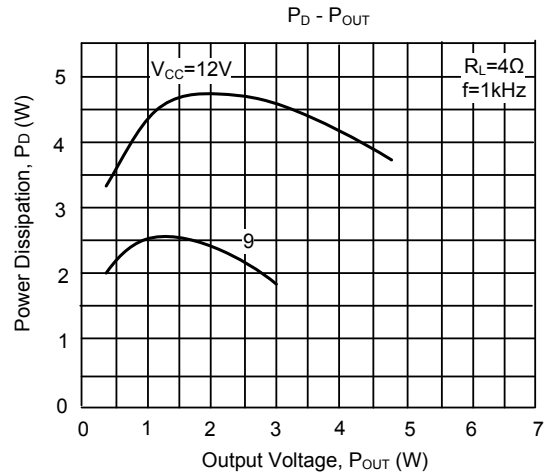
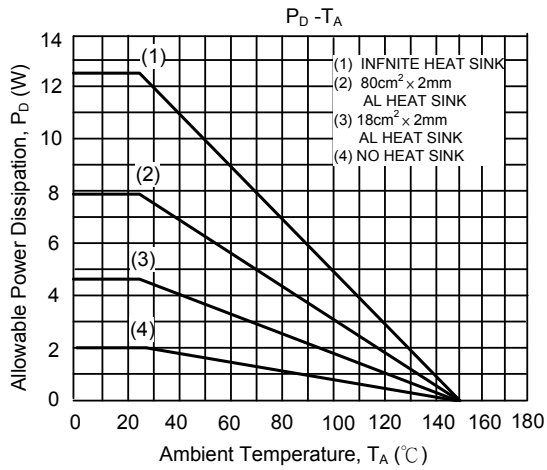
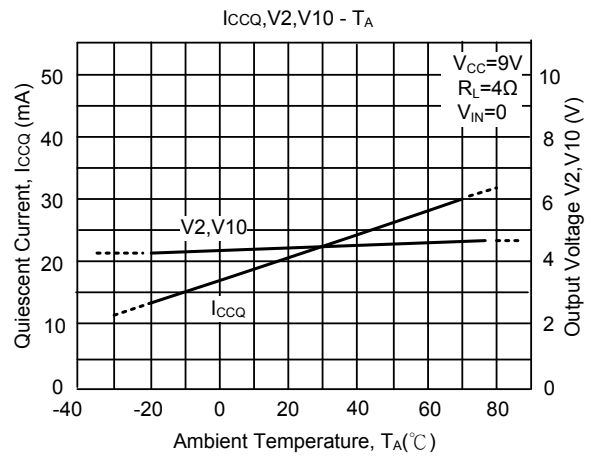
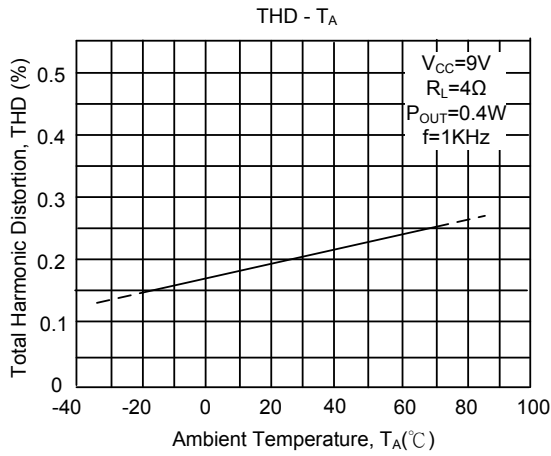

TYPICAL CHARACTERISTICS (Cont.)

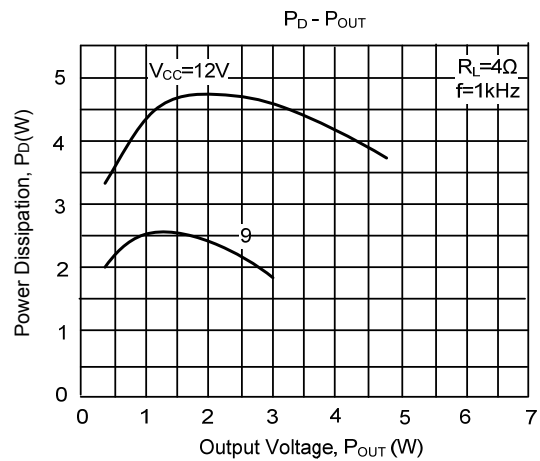
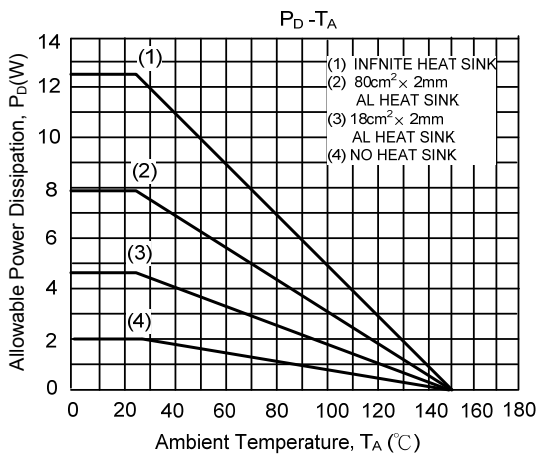
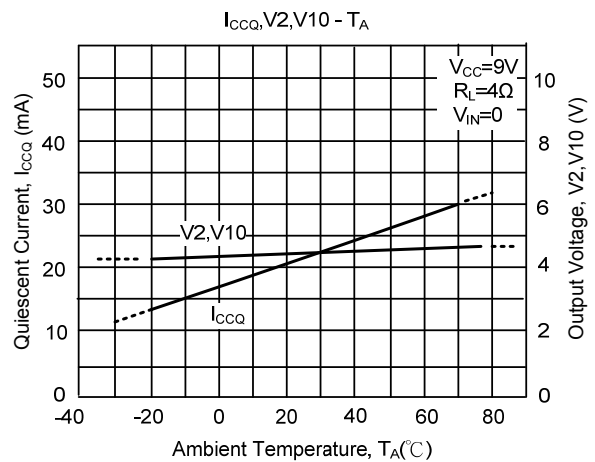
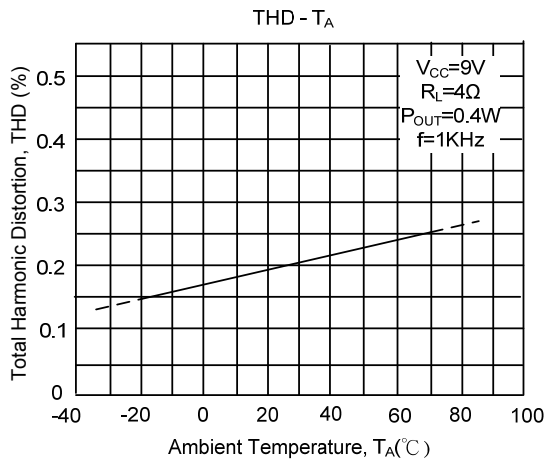

UTC assumes no responsibility for equipment failures that result from using products at values that exceed, even momentarily, rated values (such as maximum ratings, operating condition ranges, or other parameters) listed in products specifications of any and all UTC products described or contained herein. UTC products are not designed for use in life support appliances, devices or systems where malfunction of these products can be reasonably expected to result in personal injury. Reproduction in whole or in part is prohibited without the prior written consent of the copyright owner. The information presented in this document does not form part of any quotation or contract, is believed to be accurate and reliable and may be changed without notice.