

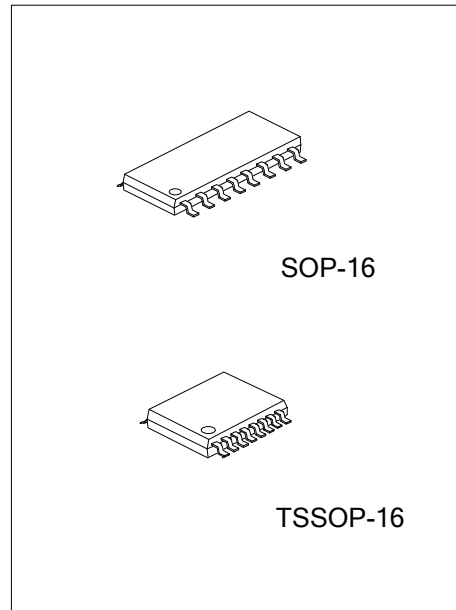

U74LVC258

CMOS IC

QUADRUPLE 2-LINE TO 1-LINE DATA SELECTORS/MULTIPLEXERS 3-STATE OUTPUTS



DESCRIPTION

The **U74LVC258** is designed for 1.65V to 3.6V V_{CC} operation.

The **U74LVC258** devices are designed to multiplex signals from 4-bit data sources to 4-output data lines in bus-organized systems. The 3-state outputs do not load the data lines when the output-enable (\overline{OE}) input is at a high logic level.

FEATURES

- * Operate From 1.65V to 3.6V
- * Input Accept Voltages to 5.5V
- * Partial-Power-Down Mode Operation
- * Max tpd is 4.6ns at 3.3V

ORDERING INFORMATION

Ordering Number		Package	Packing
Lead Free	Halogen Free		
U74LVC258L-S16-R	U74LVC258G-S16-R	SOP-16	Tape Reel
U74LVC258L-P16-R	U74LVC258G-P16-R	TSSOP-16	Tape Reel

<p>U74LVC258G-S16-R</p> <p>(1)Packing Type (2)Package Type (3)Green Package</p>	<p>(1) R: Tape Reel (2) S16: SOP-16, P16: TSSOP-16 (3) G: Halogen Free and Lead Free, L: Lead Free</p>
---	--

MARKING

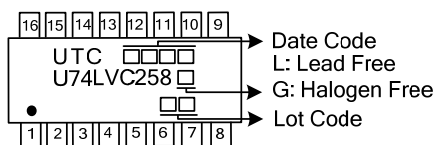

■ PIN CONFIGURATION

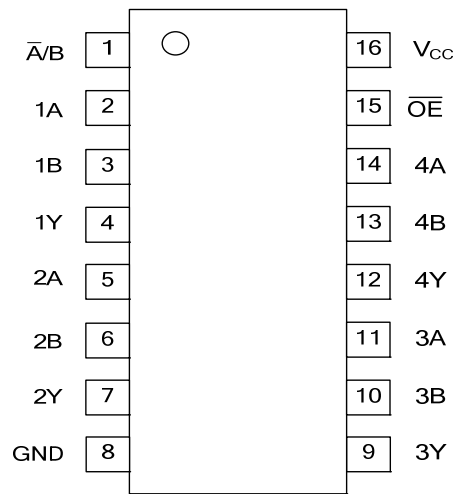

■ FUNCTION TABLE (each gate)

INPUTS				OUTPUT(Y)
INPUT(\overline{OE})	INPUT($\overline{A/B}$)	A	B	
H	X	X	X	Z
L	L	L	X	H
L	L	H	X	L
L	H	X	L	H
L	H	X	H	L

H = High voltage level ; L = Low voltage level ; X = Don't care ; Z = High-impedance OFF-state

■ LOGIC DIAGRAM (Positive Logic)

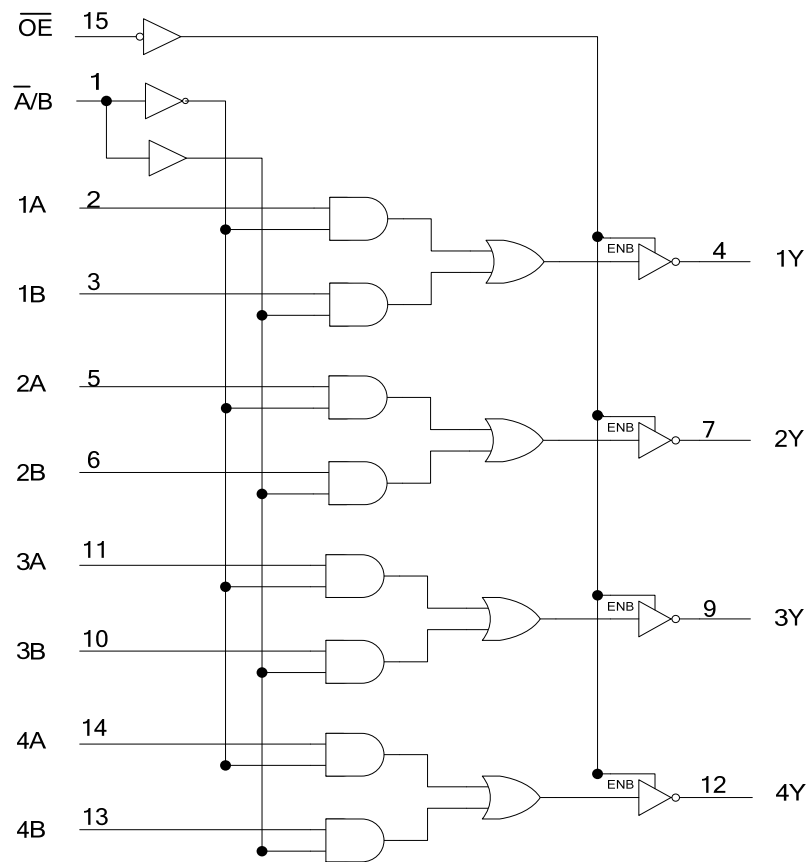

■ ABSOLUTE MAXIMUM RATING

PARAMETER	SYMBOL	CONDITIONS	RATINGS	UNIT
Supply Voltage	V_{CC}		-0.5 ~ +6.5	V
Input Voltage	V_{IN}		-0.5 ~ +6.5	V
Output Voltage	V_{OUT}	Output in the high or low state	-0.5 ~ $V_{CC} + 0.5$	V
		Output in the power-off state	-0.5 ~ +6.5	V
Continuous V_{CC} or GND Current	I_{CC}		±100	mA
Continuous Output Current	I_{OUT}	$V_{OUT}=0V \sim V_{CC}$	±50	mA
Input Clamp Current	I_{IK}	$V_{IN}<0V$	-50	mA
Output Clamp Current	I_{OK}	$V_{OUT}>V_{CC}$ or $V_{OUT}<0V$	-50	mA
Storage Temperature Range	T_{STG}		-65 ~ +150	°C

Note: Absolute maximum ratings are those values beyond which the device could be permanently damaged. Absolute maximum ratings are stress ratings only and functional device operation is not implied.

■ RECOMMENDED OPERATING CONDITIONS

PARAMETER	SYMBOL	TEST CONDITIONS	MIN	TYP	MAX	UNIT
Supply Voltage	V_{CC}	Operating	1.65		3.6	V
		Data retention only	1.5			V
Input Voltage	V_{IN}		0		5.5	V
Output Voltage	V_{OUT}		0		V_{CC}	V
Operating Temperature	T_A		-40		85	°C
Input Transition Rise or Fall Rate	$\Delta t/\Delta v$	$V_{CC}=1.65V \sim 2.7V$	0		20	ns/V
		$V_{CC}=2.7V \sim 3.6V$	0		10	ns/V

■ ELECTRICAL CHARACTERISTICS ($T_A = 25^\circ C$, unless otherwise specified)

PARAMETER	SYMBOL	TEST CONDITIONS	MIN	TYP	MAX	UNIT
High-level Input Voltage	V_{IH}	$V_{CC}=1.8V \pm 0.15V$	$0.65 \times V_{CC}$			V
		$V_{CC}=2.5V \pm 0.2V$	1.7			V
		$V_{CC}=3.3V \pm 0.3V$	2			V
Low-level Input Voltage	V_{IL}	$V_{CC}=1.8V \pm 0.15V$			$0.35 \times V_{CC}$	V
		$V_{CC}=2.5V \pm 0.2V$			0.7	V
		$V_{CC}=3.3V \pm 0.3V$			0.8	V
High-Level Output Voltage	V_{OH}	$V_{CC}=1.65V \sim 3.6V, I_{OH}=-100\mu A$	$V_{CC}-0.2$			V
		$V_{CC}=1.65V, I_{OH}=-4mA$	1.2			V
		$V_{CC}=2.3V, I_{OH}=-8mA$	1.8			V
		$V_{CC}=2.7V, I_{OH}=-12mA$	2.2			V
		$V_{CC}=3.0V$				
		$I_{OH}=-12mA$	2.4			V
		$I_{OH}=-24mA$	2.2			V
Low-Level Output Voltage	V_{OL}	$V_{CC}=1.65V \sim 3.6V, I_{OH}=100\mu A$			0.2	V
		$V_{CC}=1.65V, I_{OH}=4mA$			0.45	V
		$V_{CC}=2.3V, I_{OH}=8mA$			0.7	V
		$V_{CC}=2.7V, I_{OH}=12mA$			0.4	V
		$V_{CC}=3.0V, I_{OH}=24mA$			0.55	V
Input Leakage Current	$I_{I(LEAK)}$	$V_{CC}=3.6V, V_{IN}=5.5V$ or GND			±5	μA
Power OFF Leakage Current	I_{off}	$V_{CC}=0V, V_{IN}$ or $V_{OUT}=5.5V$			±10	μA
OFF-state output current	I_{OZ}	$V_{CC}=3.6V, V_{IN} = V_{IH}$ or $V_{IL}, V_{OUT}=V_{CC}$ or GND			±10	μA

■ ELECTRICAL CHARACTERISTICS (T_A =25°C , unless otherwise specified)

PARAMETER	SYMBOL	TEST CONDITIONS	MIN	TYP	MAX	UNIT
Quiescent Supply Current	I _{CC}	V _{CC} =3.6V, V _{IN} =V _{CC} or GND, I _{OUT} =0A			10	μA
Additional Quiescent Supply Current Per Input Pin	ΔI _{CC}	V _{CC} =2.7V~3.6V, One input at V _{CC} -0.6V, Other inputs at V _{CC} or GND			500	μA
Input Capacitance	C _I	V _{CC} = 3.3V, V _{IN} = V _{CC} or GND		5.0		pF
Output Capacitance	C _O	V _{CC} = 3.3V, V _{IN} = V _{CC} or GND		5.0		pF

■ SWITCHING CHARACTERISTICS (T_A =25°C , unless otherwise specified)

PARAMETER	SYMBOL	TEST CONDITIONS	MIN	TYP	MAX	UNIT	
Propagation delay from input (A or B) to output(Y)	t _{PD}	C _L =30pF	V _{CC} =1.8V±0.15V	1		13.5	ns
			V _{CC} =2.5V±0.2V	1		7.4	ns
		C _L =50pF	V _{CC} =2.7V	1		5.7	ns
			V _{CC} =3.3V±0.3V	1		4.6	ns
Propagation delay from input (\bar{A} / B) to output(Y)	t _{en}	C _L =30pF	V _{CC} =1.8V±0.15V	1		15.5	ns
			V _{CC} =2.5V±0.2V	1		9.6	ns
		C _L =50pF	V _{CC} =2.7V	1		7.5	ns
			V _{CC} =3.3V±0.3V	1		6.4	ns
Propagation delay from input (\overline{OE}) to output(Y)	t _{en}	C _L =30pF	V _{CC} =1.8V±0.15V	1		14.6	ns
			V _{CC} =2.5V±0.2V	1		8.7	ns
		C _L =50pF	V _{CC} =2.7V	1		6.7	ns
			V _{CC} =3.3V±0.3V	1		5.6	ns
Propagation delay from input (\overline{OE}) to output(Y)	t _{dis}	C _L =30pF	V _{CC} =1.8V±0.15V	1		15.4	ns
			V _{CC} =2.5V±0.2V	1		6.7	ns
		C _L =50pF	V _{CC} =2.7V	1		4.7	ns
			V _{CC} =3.3V±0.3V	1		4.3	ns

■ OPERATING CHARACTERISTICS (f=10MHz, T_A =25°C , unless otherwise specified)

PARAMETER	SYMBOL	TEST CONDITIONS	MIN	TYP	MAX	UNIT
Power Dissipation Capacitance	C _{PD}	V _{CC} =1.8V±0.15V		13.5		pF
		V _{CC} =2.5V±0.2V		14.5		pF
		V _{CC} =3.3V±0.3V		15.5		pF

TEST CIRCUIT AND WAVEFORMS

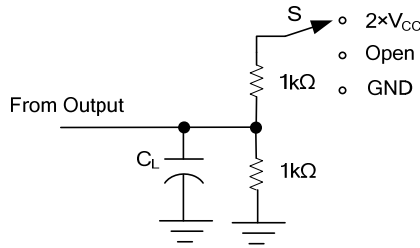

TEST CIRCUIT

TEST	S
t_{PLH}/t_{PHL}	Open
t_{PHZ}/t_{PZH}	GND
t_{PLZ}/t_{PZL}	$2 \times V_{CC}$

V_{CC}	INPUTS		V_M	V_{Δ}	C_L	R_L
	V_{IN}	t_R/t_F				
$1.8V \pm 0.15V$	V_{CC}	$\leq 2ns$	$V_{CC}/2$	0.15V	30pF	1K Ω
$2.5V \pm 0.2V$	V_{CC}	$\leq 2ns$	$V_{CC}/2$	0.15V	30pF	500 Ω
2.7V	2.7V	$\leq 2.5ns$	1.5V	0.3V	50pF	500 Ω
$3.3V \pm 0.3V$	2.7V	$\leq 2.5ns$	1.5V	0.3V	50pF	500 Ω

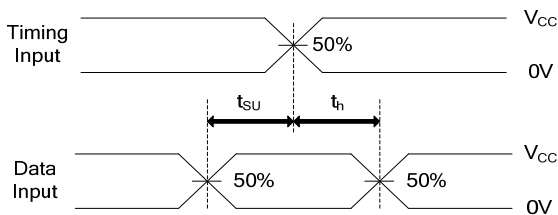

SETUP TIME AND HOLD TIME

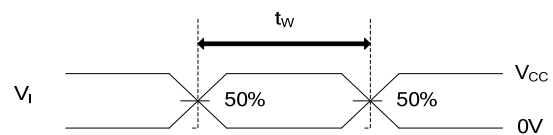

PULSE WIDTH

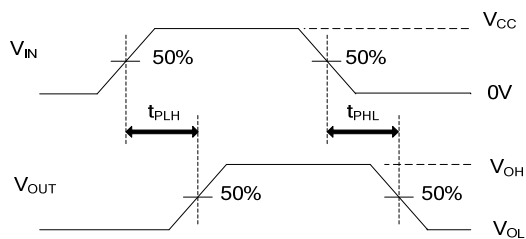

PROPAGATION DELAY TIMES

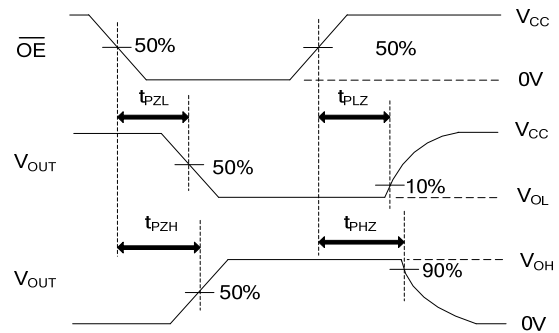

ENABLE AND DISABLE TIMES

Notes: 1. C_L includes probe and jig capacitance.

2. All input pulses are supplied by generators having the following characteristics: PRR $\leq 10MHz$, $Z_0 = 50\Omega$.

UTC assumes no responsibility for equipment failures that result from using products at values that exceed, even momentarily, rated values (such as maximum ratings, operating condition ranges, or other parameters) listed in products specifications of any and all UTC products described or contained herein. UTC products are not designed for use in life support appliances, devices or systems where malfunction of these products can be reasonably expected to result in personal injury. Reproduction in whole or in part is prohibited without the prior written consent of the copyright owner. UTC reserves the right to make changes to information published in this document, including without limitation specifications and product descriptions, at any time and without notice. This document supersedes and replaces all information supplied prior to the publication hereof.