



## U74LVC3G17

CMOS IC

### TRIPLE SCHMITT-TRIGGER BUFFER

#### DESCRIPTION

The **U74LVC3G17** is designed as three independent buffers with Schmitt-trigger action. it may have different input threshold levels for positive-going ( $V_{T+}$ ) and negative-going ( $V_{T-}$ ) signals.

This device has power-down protective circuit, preventing device destruction when it is powered down.

#### FEATURES

- \* Wide supply voltage range from 1.65V to 5.5V
- \* Inputs accept voltages up to 5.5V
- \*  $I_{OFF}$  supports partial-power-down mode
- \* Low static power consumption;  $I_{CC}=10\mu A$  (Max.)

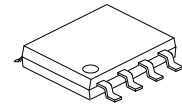

SOP-8

#### ORDERING INFORMATION

Ordering Number	Package	Packing
U74LVC3G17G-S08-R	SOP-8	Tape Reel

<p>U74LVC3G17G-S08-R</p> <p>(1) Packing Type (2) Package Type (3) Green Package</p>	<p>(1) R: Tape Reel (2) S08: SOP-8 (3) G: Halogen Free and Lead Free</p>
---	--

#### MARKING

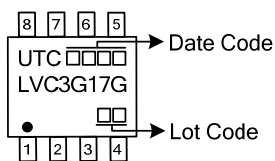

■ PIN CONFIGURATION

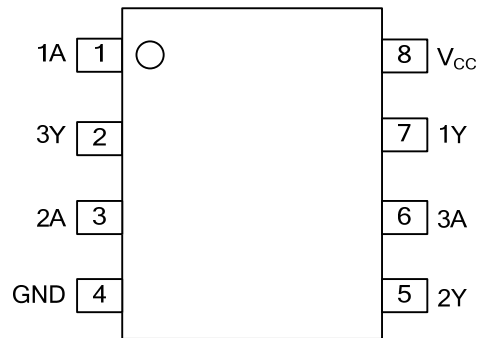

■ FUNCTION TABLE

INPUT(A)	OUTPUT(Y)
L	L
H	H

Note: H: High voltage level; L: Low voltage level.

■ LOGIC DIAGRAM (positive logic)

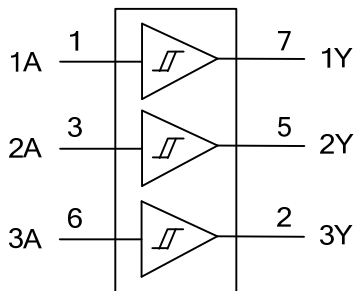

Logic symbol

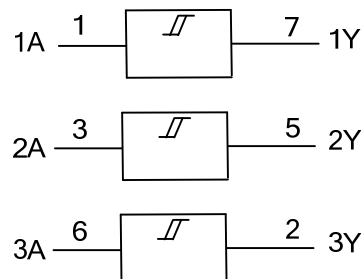

IEC logic symbol

### ■ ABSOLUTE MAXIMUM RATING

PARAMETER	SYMBOL	CONDITIONS	RATINGS	UNIT
Supply Voltage	$V_{CC}$		-0.5 ~ +6.5	V
Input Voltage	$V_{IN}$		-0.5 ~ +6.5	V
Output Voltage	$V_{OUT}$	Output in the high or low state	-0.5 ~ + $V_{CC}+0.5$	V
		Output in the power-off state	-0.5 ~ +6.5	V
Continuous $V_{CC}$ or GND Current	$I_{CC}$		±100	mA
Continuous Output Current	$I_{OUT}$	$V_{OUT}=0V \sim V_{CC}$	±50	mA
Input Clamp Current	$I_{IK}$	$V_{IN}<0V$	-50	mA
Output Clamp Current	$I_{OK}$	$V_{OUT}>V_{CC}$ or $V_{OUT}<0V$	-50	mA
Storage Temperature Range	$T_{STG}$		-65 ~ +150	°C

Note: Absolute maximum ratings are those values beyond which the device could be permanently damaged. Absolute maximum ratings are stress ratings only and functional device operation is not implied.

### ■ RECOMMENDED OPERATING CONDITIONS

PARAMETER	SYMBOL	TEST CONDITIONS	MIN	TYP	MAX	UNIT
Supply Voltage	$V_{CC}$		1.65		5.5	V
Input Voltage	$V_{IN}$		0		5.5	V
Output Voltage	$V_{OUT}$	High or low state	0		$V_{CC}$	V
Operating Temperature (Note)	$T_A$		-40		125	°C
Input Transition Rise or Fall Rate	$\Delta t/\Delta v$	$V_{CC}=1.8V\pm 0.15V, 2.5V\pm 0.2V$			20	ns/V
		$V_{CC}=3.3V\pm 0.3V$			10	ns/V
		$V_{CC}=5V\pm 0.5V$			5	ns/V

Note: This condition is only determined from design. It can't be 100% tested in mass production.

### ■ ELECTRICAL CHARACTERISTICS ( $T_A = 25^\circ C$ , unless otherwise specified)

PARAMETER	SYMBOL	TEST CONDITIONS	MIN	TYP	MAX	UNIT
Positive-Going Input Threshold Voltage	$V_{T+}$	$V_{CC}=1.65V$	0.79		1.16	V
		$V_{CC}=2.3V$	1.11		1.56	V
		$V_{CC}=3V$	1.5		1.87	V
		$V_{CC}=4.5V$	2.16		2.74	V
		$V_{CC}=5.5V$	2.61		3.33	V
Negative-Going Input Threshold Voltage	$V_{T-}$	$V_{CC}=1.65V$	0.39		0.7	V
		$V_{CC}=2.3V$	0.58		1.1	V
		$V_{CC}=3V$	0.84		1.3	V
		$V_{CC}=4.5V$	1.41		2	V
		$V_{CC}=5.5V$	1.87		2.5	V
Hysteresis Voltage ( $V_{T+}-V_{T-}$ )	$\Delta V_T$	$V_{CC}=1.65V$	0.3		0.62	V
		$V_{CC}=2.3V$	0.4		0.77	V
		$V_{CC}=3V$	0.4		0.87	V
		$V_{CC}=4.5V$	0.6		1.04	V
		$V_{CC}=5.5V$	0.7		1.11	V

### ■ ELECTRICAL CHARACTERISTICS (Cont.)

PARAMETER	SYMBOL	TEST CONDITIONS	MIN	TYP	MAX	UNIT	
High-Level Output Voltage	$V_{OH}$	$V_{CC}=1.65 \sim 5.5V, I_{OH}=-100\mu A$	$V_{CC}-0.1$			V	
		$V_{CC}=1.65V, I_{OH}=-4mA$	1.2			V	
		$V_{CC}=2.3V, I_{OH}=-8mA$	1.9			V	
		$V_{CC}=3V$	$I_{OH}=-16mA$	2.4			V
			$I_{OH}=-24mA$	2.3			V
		$V_{CC}=4.5V, I_{OH}=-32mA$	3.8				V
Low-Level Output Voltage	$V_{OL}$	$V_{CC}=1.65 \sim 5.5V, I_{OH}=100\mu A$			0.1	V	
		$V_{CC}=1.65V, I_{OH}=4mA$			0.45	V	
		$V_{CC}=2.3V, I_{OH}=8mA$			0.3	V	
		$V_{CC}=3V$	$I_{OH}=16mA$			0.4	V
			$I_{OH}=24mA$			0.55	V
		$V_{CC}=4.5V, I_{OH}=32mA$				0.55	V
Input Leakage Current	$I_{I(LEAK)}$	$V_{CC}=0 \sim 5.5V, V_{IN}=5.5V$ or GND			$\pm 5$	$\mu A$	
Power OFF Leakage Current	$I_{off}$	$V_{CC}=0V, V_{IN}$ or $V_{OUT}=5.5V$			$\pm 10$	$\mu A$	
Quiescent Supply Current	$I_{CC}$	$V_{CC}=1.65 \sim 5.5V, V_{IN}=5.5V$ or GND, $I_{OUT}=0A$			10	$\mu A$	
Additional Quiescent Supply Current Per Input Pin	$\Delta I_{CC}$	$V_{CC}=3 \sim 5.5V$ , One input at $V_{CC}-0.6V$ , Other inputs at $V_{CC}$ or GND			500	$\mu A$	
Input Capacitance	$C_I$	$V_{CC}=3.3V, V_{IN}=V_{CC}$ or GND		4		pF	

### ■ SWITCHING CHARACTERISTICS ( $T_A=25^\circ C$ , unless otherwise specified)

PARAMETER	SYMBOL	TEST CONDITIONS	MIN	TYP	MAX	UNIT
Propagation delay from input (A) to output(Y)	$t_{PD}$	$V_{CC}=1.8\pm 0.15V, C_L=30pF, R_L=1k\Omega$	4.3		9.2	ns
		$V_{CC}=2.5\pm 0.2V, C_L=30pF, R_L=500\Omega$	2		6.2	ns
		$V_{CC}=3.3\pm 0.3V, C_L=50pF, R_L=500\Omega$	1.2		5.4	ns
		$V_{CC}=5\pm 0.5V, C_L=50pF, R_L=500\Omega$	1		4.1	ns

### ■ OPERATING CHARACTERISTICS ( $f=10MHz, T_A=25^\circ C$ , unless otherwise specified)

PARAMETER	SYMBOL	TEST CONDITIONS	MIN	TYP	MAX	UNIT
Power Dissipation Capacitance	$C_{PD}$	$V_{CC}=1.8V$		18		pF
		$V_{CC}=2.5V$		19		pF
		$V_{CC}=3.3V$		19		pF
		$V_{CC}=5V$		22		pF

## TEST CIRCUIT AND WAVEFORMS

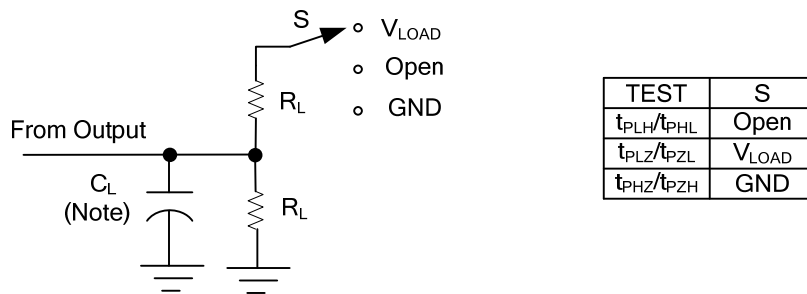

Note:  $C_L$  includes probe and jig capacitance.

$V_{CC}$	Inputs		$V_M$	$V_{LOAD}$	$C_L$	$R_L$	$V_{\Delta}$
	$V_{IN}$	$t_R, t_F$					
$1.8V \pm 0.15V$	$V_{CC}$	$\leq 2ns$	$V_{CC}/2$	$2 \times V_{CC}$	15pF	1M $\Omega$	0.15V
$2.5V \pm 0.2V$	$V_{CC}$	$\leq 2ns$	$V_{CC}/2$	$2 \times V_{CC}$	15pF	1M $\Omega$	0.15V
$3.3V \pm 0.3V$	3V	$\leq 2.5ns$	1.5V	6V	15pF	1M $\Omega$	0.3V
$5V \pm 0.5V$	$V_{CC}$	$\leq 2.5ns$	$V_{CC}/2$	$2 \times V_{CC}$	15pF	1M $\Omega$	0.3V

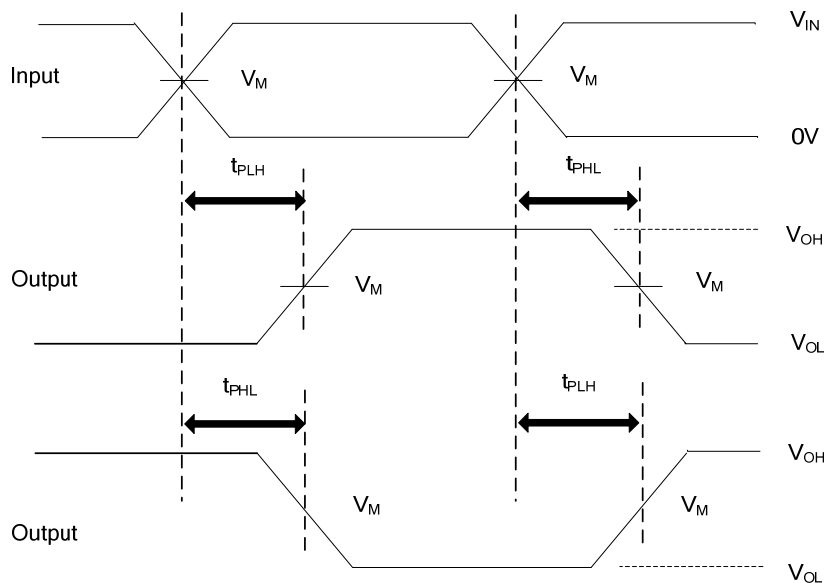

PROPAGATION DELAY TIMES

- Notes: 1.  $C_L$  includes probe and jig capacitance.  
 2. All input pulses are supplied by generators having the following characteristics: PRR  $\leq 10MHz$ ,  $Z_O = 50\Omega$ .

UTC assumes no responsibility for equipment failures that result from using products at values that exceed, even momentarily, rated values (such as maximum ratings, operating condition ranges, or other parameters) listed in products specifications of any and all UTC products described or contained herein. UTC products are not designed for use in life support appliances, devices or systems where malfunction of these products can be reasonably expected to result in personal injury. Reproduction in whole or in part is prohibited without the prior written consent of the copyright owner. The information presented in this document does not form part of any quotation or contract, is believed to be accurate and reliable and may be changed without notice.