



U7SH00

CMOS IC

2-INPUT NAND GATE

DESCRIPTION

The **U7SH00** is a 2-input NAND gate providing the Function $Y = \overline{A \cdot B}$.

This device has power-down protective circuit to prevent device destruction when it is powered down.

FEATURES

- * Operation Voltage Range: 2~5.5V
- * Low power consumption: $I_{CC} = 2\mu A(\text{Max})$
- * High Speed: $t_{PD} = 3.7\text{ns}(\text{TYP})$
- * High Noise Immunity
- * Power Down Protection

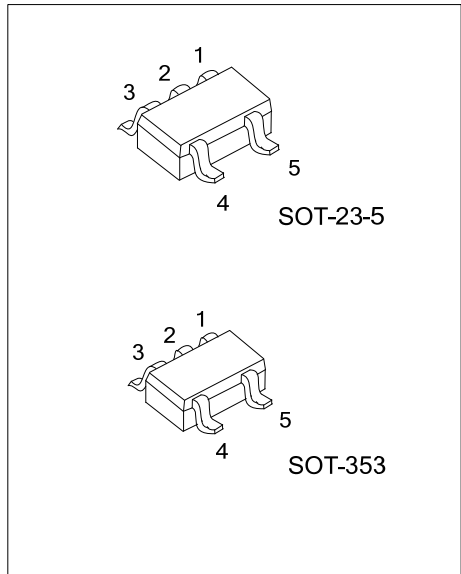

ORDERING INFORMATION

Order Number		Package	Packing
Lead Free	Halogen Free		
U7SH00L-AE5-R	U7SH00G-AE5-R	SOT-23-5	Tape Reel
U7SH00L-AL5-R	U7SH00G-AL5-R	SOT-353	Tape Reel

<p>U7SH00L-AF5-R</p> <p>(1) Packing Type (2) Package Type (3) Lead Free</p>	<p>(1) R: Tape Reel (2) AE5: SOT-23-5, AL5: SOT-353 (3) G: Halogen Free, L: Lead Free</p>
---	---

MARKING

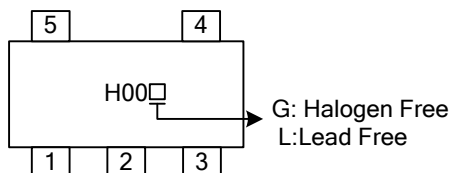

■ PIN CONFIGURATION

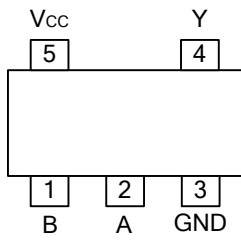

■ FUNCTION TABLE (each gate)

INPUT		OUTPUT
A	B	Y
L	L	H
L	H	H
H	L	H
H	H	L

■ LOGIC DIAGRAM (positive logic)

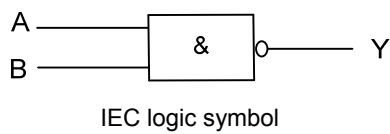
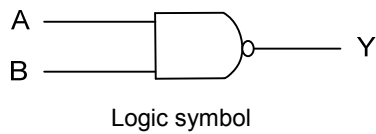

■ ABSOLUTE MAXIMUM RATING (unless otherwise specified)(Note 1)

PARAMETER	SYMBOL	RATINGS	UNIT
Supply Voltage	V _{CC}	-0.5~7	V
Input Voltage	V _{IN}	-0.5~7	V
Output Voltage	V _{OUT}	-0.5~V _{CC} +0.5	V
Input Clamp Current	I _{IK}	-20	mA
Output Clamp Current	I _{OK}	±20	mA
Output Current	I _{OUT}	±25	mA
V _{CC} or GND Current	I _{CC}	±50	mA
Power Dissipation	P _D	200	mW
Storage Temperature	T _{STG}	-65 ~ +150	°C

Note 1. The input and output voltage ratings may be exceeded if the input and output current ratings are observed.

2. Absolute maximum ratings are those values beyond which the device could be permanently damaged.

Absolute maximum ratings are stress ratings only and functional device operation is not implied.

■ RECOMMENDED OPERATING CONDITIONS

PARAMETER	SYMBOL	CONDITIONS	MIN	TYP	MAX	UNIT
Supply Voltage	V _{CC}		2		5.5	V
Input Voltage	V _{IN}		0		5.5	V
Output Voltage	V _{OUT}		0		V _{CC}	V
Input Transition Rise or Fall Rate	Δt/ΔV	V _{CC} =3.3±0.3V			100	ns/V
		V _{CC} =5.0±0.5V			20	
Operating Temperature	T _A		-40		85	°C

■ ELECTRICAL CHARACTERISTICS (T_A =25°C , unless otherwise specified)

PARAMETER	SYMBOL	TEST CONDITIONS	MIN	TYP	MAX	UNIT	
High-Level Input Voltage	V _{IH}	V _{CC} =2V	1.5			V	
		V _{CC} =3V ~ 5.5V	0.7*V _{CC}			V	
Low-Level Input Voltage	V _{IL}	V _{CC} =2V			0.5	V	
		V _{CC} =3V ~ 5.5V			0.3*V _{CC}	V	
High-Level Output Voltage	V _{OH}	I _{OH} =-50μA	V _{CC} =2V	1.9	2	V	
			V _{CC} =3V	2.9	3	V	
			V _{CC} =4.5V	4.4	4.5	V	
		I _{OH} =-4mA	V _{CC} =3.0V	2.58		V	
		I _{OH} =-8mA	V _{CC} =4.5V	3.94		V	
Low-Level Output Voltage	V _{OL}	I _{OH} =50μA	V _{CC} =2V		0	0.1	V
			V _{CC} =3V		0	0.1	V
			V _{CC} =4.5V		0	0.1	V
		I _{OH} =4mA	V _{CC} =3.0V			0.36	V
		I _{OH} =8mA	V _{CC} =4.5V			0.36	V
Input Leakage Current	I _{I(LEAK)}	V _{IN} = 5.5V or GND, V _{CC} =0 ~ 5.5V			±0.1	μA	
Quiescent Supply Current	I _{CC}	V _{IN} =V _{CC} or GND, I _{OUT} =0, V _{CC} =5.5V			2	μA	
Input Capacitance	C _{IN}	V _{IN} =V _{CC} or GND, V _{CC} =5V		4	10	pF	

■ SWITCHING CHARACTERISTICS (T_A=25°C, Input: t_R, t_F=3ns)

PARAMETER	SYMBOL	TEST CONDITIONS	MIN	TYP	MAX	UNIT
Propagation delay from input (A or B) to output(Y)	t _{PLH}	V _{CC} =3.3±0.3V, C _L =15pF		5.5	7.9	ns
	t _{PHL}	V _{CC} =5.0±0.5V, C _L =15pF		3.7	5.5	ns
Propagation delay from input (A or B) to output(Y)	t _{PLH}	V _{CC} =3.3±0.3V, C _L =50pF		8.0	11.4	ns
	t _{PHL}	V _{CC} =5.0±0.5V, C _L =50pF		5.2	7.5	ns

■ OPERATING CHARACTERISTICS

PARAMETER	SYMBOL	TEST CONDITIONS	MIN	TYP	MAX	UNIT
Power Dissipation Capacitance	C _{PD}	No load		14		pF

■ TEST CIRCUIT AND WAVEFORMS

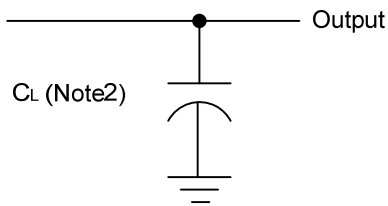

Note 2: CL includes probe and jig capacitance.

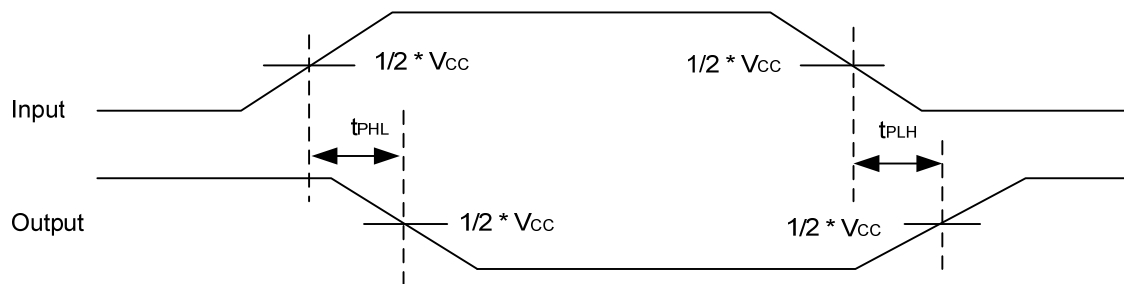

UTC assumes no responsibility for equipment failures that result from using products at values that exceed, even momentarily, rated values (such as maximum ratings, operating condition ranges, or other parameters) listed in products specifications of any and all UTC products described or contained herein. UTC products are not designed for use in life support appliances, devices or systems where malfunction of these products can be reasonably expected to result in personal injury. Reproduction in whole or in part is prohibited without the prior written consent of the copyright owner. The information presented in this document does not form part of any quotation or contract, is believed to be accurate and reliable and may be changed without notice.