



UC3873A

LINEAR INTEGRATED CIRCUIT

LOW COST POWER-SAVING MODE PWM CONTROLLER FOR FLYBACK CONVERTERS

■ DESCRIPTION

The UTC **UC3873A** is a high performance current mode PWM controller ideally suited for low standby power. Low V_{DD} startup current make the power reliable on startup design and a large value resistor could be used in the startup circuit to minimize the standby power. At no load condition, the IC operates in power-saving mode for lower standby power, decreasing frequency for Higher conversion efficiency at light load condition.

The UTC **UC3873A** contains protection with automatic recovery including OLP (over load protection), OCP (cycle-by-cycle current limiting), and UVLO (V_{DD} over voltage clamp and under voltage lockout). It also provides the protections including OTP (over temperature protection), OVP (over voltage protection) in UTC **UC3873A** with automatic recovery. To protect the power MOSFET, Gate-drive output is fixed up to 16V max.

The internal slope compensation improves system stability at high PWM duty cycle output. Leading-edge blanking on current sense input removes the signal glitch, which offering minimal external component count in the design. Excellent EMI performance is achieved with UTC proprietary frequency hopping technique (ZL201020615247.1) together with soft driver control. Audio noise is eliminated due to switch frequency more than 20kHz during operation.

The UTC **UC3873A** has such applications as: battery charger, power adaptor, set-top box power supplies, ink jet printers, open-frame SMPS.

■ FEATURES

- * UTC proprietary frequency hopping technology for Improved EMI performance.
- * Power-saving mode for high light-load and standby efficiency
- * Soft Start
- * Dynamic peak current limiting for constant output power
- * Built-in synchronized slope compensation
- * OLP with automatic recovery
- * OTP and OVP(automatic recovery)
- * V_{DD} clamp for higher security
- * Programming OTP for higher security
- * Fixed switch frequency 65kHz
- * Gate output voltage clamped at 16V
- * Low start-up current
- * Cycle-by-cycle current limiting
- * Under voltage lockout (UVLO)
- * Few external components required

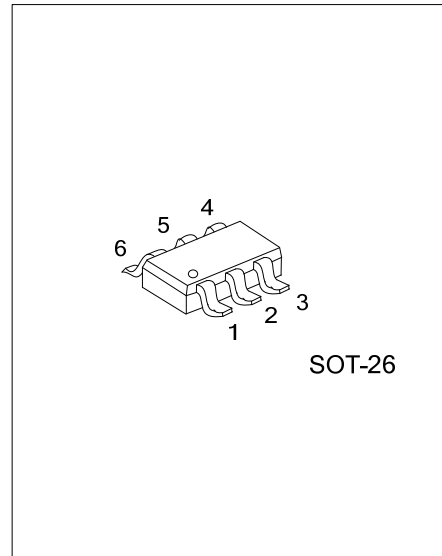

ORDERING INFORMATION

Ordering Number		Package	Packing
Lead Free	Halogen Free		
UC3873AL-AG6-R	UC3873AG-AG6-R	SOT-26	Tape Reel

<p>UC3873AG-AG6-R</p> <ul style="list-style-type: none"> (1) Packing Type (2) Package Type (3) Green Package 	<ul style="list-style-type: none"> (1) R: Tape Reel (2) AG6: SOT-26 (3) G: Halogen Free and Lead Free, L: Lead Free
-----------------------------------------------------------------------------------------------------------------------------------------------	------------------------------------------------------------------------------------------------------------------------------------------------------

MARKING

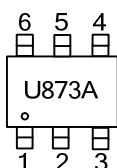

PIN CONFIGURATION

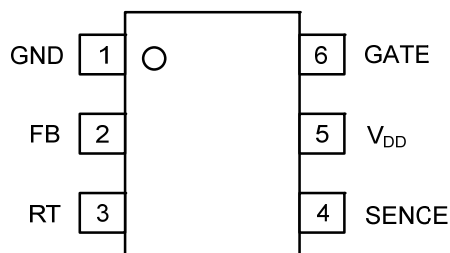

PIN DESCRIPTION

PIN NO.	PIN NAME	PIN TYPE	DESCRIPTION
1	GND	P	Ground.
2	FB	I	Feedback input pin. The PWM duty cycle is determined by voltage level into this pin and SENSE pin input.
3	RT	I	Connected through a NTC resistor to GND for OTP.
4	SENSE	I	Current sense input pin. Connected to MOSFET current sensing resistor node.
5	V _{DD}	P	Power supply.
6	GATE	O	The totem-pole output driver for driving the power MOSFET.

■ ABSOLUTE MAXIMUM RATINGS ($T_A=25^{\circ}\text{C}$, $V_{DD}=15\text{V}$, unless otherwise specified)

PARAMETER	SYMBOL	RATINGS	UNIT
Supply Voltage	V_{DD}	35	V
Input Voltage to FB Pin	V_{FB}	-0.3 ~ 7	V
Input Voltage to CS Pin	V_{SENSE}	-0.3 ~ 7	V
Junction Temperature	T_J	+150	$^{\circ}\text{C}$
Operating Temperature	T_{OPR}	-40 ~ +125	$^{\circ}\text{C}$
Storage Temperature	T_{STG}	-50 ~ +150	$^{\circ}\text{C}$

Note: Absolute maximum ratings are those values beyond which the device could be permanently damaged. Absolute maximum ratings are stress ratings only and functional device operation is not implied.

■ OPERATING RANGE

PARAMETER	SYMBOL	RATINGS	UNIT
Supply Voltage	V_{DD}	10 ~ 24	V

■ ELECTRICAL CHARACTERISTICS ($T_A=25^{\circ}\text{C}$, $V_{DD}=15\text{V}$, unless otherwise specified)

PARAMETER	SYMBOL	TEST CONDITIONS	MIN	TYP	MAX	UNIT
SUPPLY SECTION						
Start Up Current	I_{STR}	$V_{DD} = V_{DD(ON)} - 0.5\text{V}$		2	15	μA
IC Operating Current	I_{OP}	$V_{FB}=3.5\text{V}$		0.8	1.8	mA
V_{CC} Zener Clamp Voltage	$V_{CC(\text{clamp})}$	$I_{VCC}=20\text{mA}$	31	33	35	V
UNDER-VOLTAGE LOCKOUT SECTION						
Start Threshold Voltage	$V_{THD(ON)}$		16	18	20	V
Min. Operating Voltage	$V_{DD(MIN)}$		6	7	8	V
CONTROL SECTION						
V_{FB} Open Loop Voltage Level	$V_{FB-OPEN}$			5.4		V
PWM Input Gain	A_{VCS}	$\Delta V_{FB}/\Delta V_{CS}$		3		V/V
Burst-Mode Out FB Voltage	$V_{FB(OUT)}$	$V_{SENSE}=0$		1.5		V
Burst-Mode Enter FB Voltage	$V_{FB(IN)}$	$V_{SENSE}=0$		1.35		V
Switch Frequency	Normal	F_{SW}	60	65	70	KHz
	Power-Saving					
Duty Cycle	D_{MAX}	$V_{FB}=3.5\text{V}$, $V_{SENSE}=0$	70	78	90	%
Frequency Hopping	$F_{J(SW)}$		-9		+9	%
Frequency VDD Stability	F_{DV}	$V_{DD}=12\text{V}\sim 20\text{V}$			10	%
Frequency Temperature Stability	F_{DT}	$T=-40\sim 110^{\circ}\text{C}$			10	%
PROTECTION SECTION						
V_{CC} Over Voltage Protection Threshold	V_{OVP}	$V_{FB}=3.9\text{V}$	25	27	29	V
FB PIN Over Load Protection Threshold	V_{OLP}			4.2		V
Over Load Protection Delay-Time	T_{Delay}		60	88	120	mS
OTP Threshold	$T_{(THR)}$			150		$^{\circ}\text{C}$
Soft start time	T_{SS}			5		mS
CURRENT LIMITING SECTION						
Peak Current Flat Threshold Voltage	V_{CS-F}	$V_{FB}=3.9\text{V}$, Duty $\geq 60\%$		0.92		V
Peak Current Valley Threshold Voltage	V_{CS-V}	$V_{FB}=4.0\text{V}$, Duty=0%	0.60	0.65	0.70	V
Lead Edge Blanking Time	T_{LEB}		200	350	550	ns
DRIVER OUTPUT SECTION						
Output Voltage Low State	V_{OL}	$V_{DD}=15\text{V}$, $I_O=-20\text{mA}$			1	V
Output Voltage High State	V_{OH}	$V_{DD}=15\text{V}$, $I_O=20\text{mA}$	11			V
Output Voltage Rise Time	t_R	$C_L=1.0\text{nF}$		150		ns
Output Voltage Fall Time	t_F	$C_L=1.0\text{nF}$		60		ns
RT SECTION						
Output Current of RT pin	I_{RT}		93	100	107	μA
Threshold Voltage for OTP	V_{TH_OTP}		0.98	1.04	1.10	V

■ OPERATION DESCRIPTION

The UTC **UC3873A** devices integrate many useful designs into one controller for low-power switch-mode power supplies. The following descriptions highlight some of the features of the UTC **UC3873A** series.

Start-up Current

The start-up current is only 2.5 μ A. Low start-up current allows a start-up resistor with a high resistance and a low-wattage to supply the start-up power for the controller. For AC/DC adaptor with universal input range design, a 2.5~3M Ω , 1/8W startup resistor could be used together with a V_{DD} capacitor to provide a fast startup and low power dissipation solution.

Power-Saving Mode Operation

The proprietary Power-Saving Mode function provides linearly decreasing the switching frequency under light-load conditions for higher efficiency. The feedback voltage, which is sampled from the voltage feedback loop, is taken as the reference. Once the feedback voltage dropped below the threshold voltage, the switching frequency starts to decrease. This Power-Saving Mode function dramatically reduces power consumption under light-load conditions. The 20KHz minimum frequency control also eliminates the audio noise at any loading conditions.

At zero load condition, the magnitude of power loss is in proportion to the number of switching events within a fixed period of time. Reducing switching events leads to the reduction on the power loss and thus conserves the energy. The UTC **UC3873A** enter burst mode at standby condition to minimize the switching loss and reduces the standby power consumption. Power supplies using the UTC **UC3873A** can easily meet even the strictest regulations regarding standby power consumption.

Switch Frequency Set

The maximum switch frequency is fixed to 65KHz. Switch frequency is modulated by output power P_{OUT} during IC operating. At no load or light load condition, most of the power dissipation in a switching mode power supply is from switching loss on the MOSFET transistor, the core loss of the transformer and the loss on the snubber circuit. The magnitude of power loss is in proportion to the number of switching events within a fixed period of time. So lower switch frequency at lower load, which more and more improve IC's efficiency at light load. At from no load to light load condition, The IC will operate at from Burst mode to Reducing Frequency Mode. The relation curve between f_{SW} and P_{OUT}/P_{OUT (MAX)} as followed Fig.1.

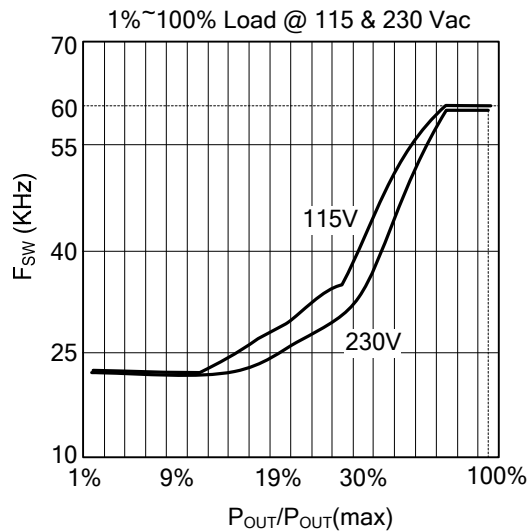

Fig.1 The relation curve between f_{SW} and relative output power P_{OUT}/P_{OUT (MAX)}

■ OPERATION DESCRIPTION (Cont.)

Frequency Hopping For EMI Improvement

The Frequency hopping is implemented in the IC; there are two oscillators built-in the IC. The first oscillator is to set the normal switching frequency; the switching frequency is modulated with a period signal generated by the 2nd oscillator. The relation between the first oscillator and the 2nd oscillator as followed Fig.2. So the tone energy is evenly spread out, the spread spectrum minimizes the conduction band EMI and therefore eases the system design in meeting stringent EMI requirement.

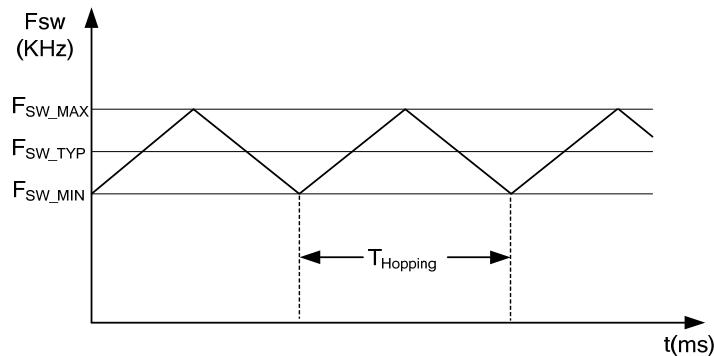

Fig.2 Frequency Hopping

Built-in Slope Compensation

Built-in slope compensation circuit greatly improves the close loop stability at CCM and prevents the sub-harmonic oscillation.

Leading-Edge Blanking

Each time the power MOSFET is switched on, a turn-on spike will inevitably occur at the sense-resistor. To avoid premature termination of the switching pulse, a 400ns leading-edge blanking time is built in. Conventional RC filtering can therefore be omitted. During this blanking period, the current-limit comparator is disabled and it cannot switch off the gate driver.

Constant Output Power Limit

When the SENSE voltage, across the sense resistor R_S , reaches the threshold voltage, around V_{CS-V} , the output GATE drive will be turned off after a small propagation delay t_D . This propagation delay will introduce an additional current proportional to $t_D \times V_{IN} / L_p$. Since the propagation delay is nearly constant regardless of the input line voltage V_{IN} . Higher input line voltage will result in a larger additional current and hence the output power limit is also higher than that under low input line voltage. To compensate this variation for wide AC input range, the threshold voltage is adjusted by the V_{IN} current. Since V_{IN} pin is connected to the rectified input line voltage through a resistor R_{VIN} , a higher line voltage will generate higher V_{IN} current into the V_{IN} pin. The threshold voltage is decreased if the V_{IN} current is increased. Smaller threshold voltage, forces the output GATE drive to terminate earlier, thus reduce the total PWM turn-on time and make the output power equal to that of low line input. This proprietary internal compensation ensures a constant output power limit for wide AC input voltage from 90VAC to 264VAC.

Under Voltage Lockout (UVLO)

The turn-on and turn-off thresholds of the UTC **UC3873A** are fixed internally at $V_{THD(ON)}/V_{DD(MIN)}$. During start-up, the hold-up capacitor must be charged to $V_{THD(ON)}$ through the start-up resistor, so that the UTC **UC3873A** will be enabled. The hold-up capacitor will continue to supply V_{DD} until power can be delivered from the auxiliary winding of the main transformer. V_{DD} must not drop below $V_{DD(MIN)}$ during this start-up process. This UVLO hysteresis window ensures that hold-up capacitor will be adequate to supply V_{DD} during start-up.

Gate Output

The UTC **UC3873A** output stage is a fast totem pole gate driver. Cross conduction has been avoided to minimize heat dissipation, increase efficiency, and enhance reliability. A good tradeoff is achieved through dead time control. The low idle loss and good EMI system design is easier to achieve with this dedicated control scheme. An internal 16V clamp is added for MOSFET gate protection at higher than expected V_{DD} input.

■ OPERATION DESCRIPTION (Cont.)

Protection Controls

The IC takes on more protection functions such as OVP, OLP and OTP etc. In case of those failure modes for continual blanking time, the driver is shut down. Driver is reset after failure is eliminated.

OVP

The OVP will shut down the switching of the power MOSFET whenever $V_{DD} > V_{OVP}$. The OVP event as followed Fig.3.

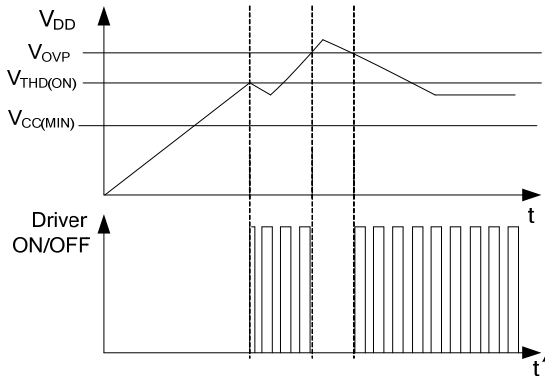

Fig.3 OVP case

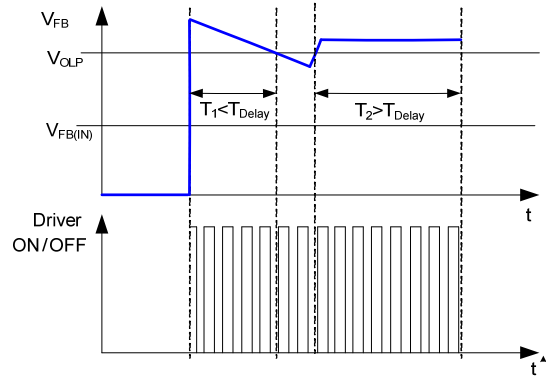

Fig.4 OLP case

OLP

OLP will shut down driver when $V_{FB} > V_{OLP}$ for continual a blanking time. The OLP event as followed Fig.4.

OTP

OTP will shut down driver when the NTC resistor temperature $T_J > T_{(THR)}$.

PCB Layout Note

Noise from the current sense or the control signal can cause significant pulse width jitter in continuous-conduction mode, and slope compensation helps alleviate these problems. Good placement and layout practices should be followed. Avoiding long PCB traces and component leads, locating compensation and filter components near the UTC **UC3873A**, and increasing the power MOS gate resistance is advised.

■ REFERENCE CIRCUIT 12W (5V/2.4A)

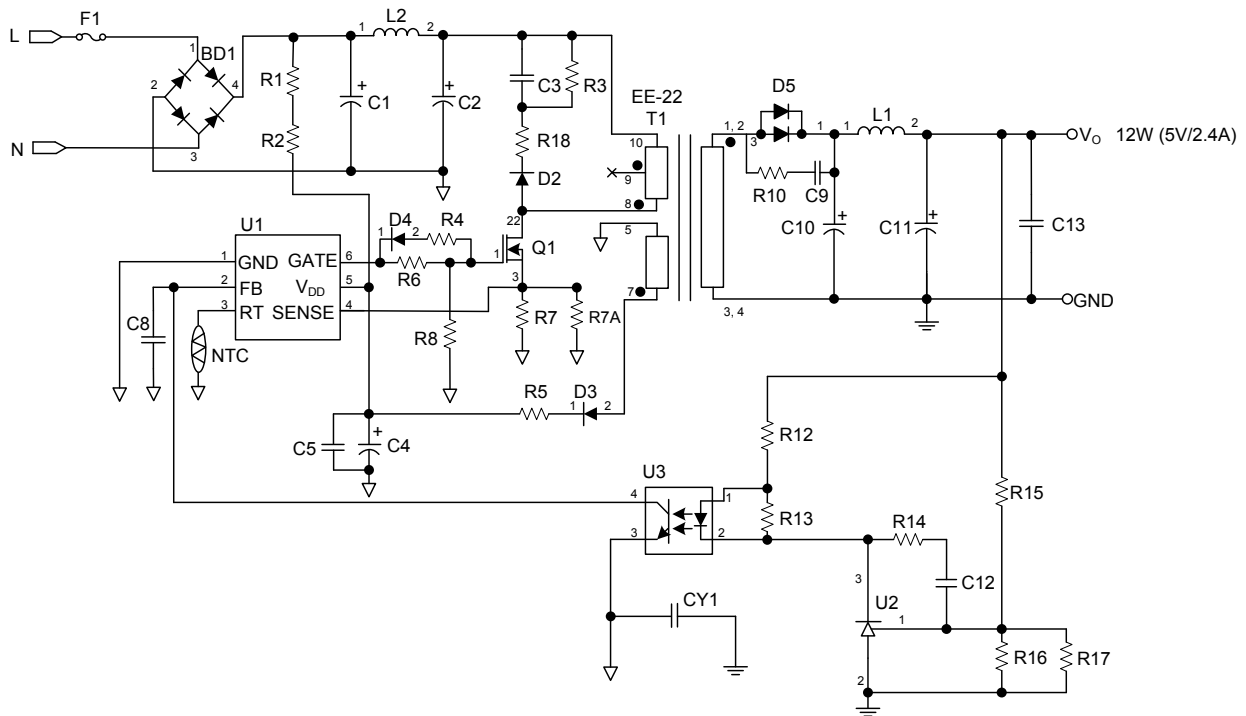

BOM

Reference	Component	Reference	Component
BD1	BD 1A/600V	L2	1mH 6×8mm
C2	EC 22μF/400V 105°C	Q1	4N60_TO-220F
C1	EC 4.7μF/400V 105°C	R1,R2	R 1.5MΩ 1206
C3	CC 0.01μF/1000V	R3	R 200KΩ 1206
C4	EC 10μF/50V	R4	R 0Ω 0805
C5,C13	CC 104P/25V 0805	R5	R 10Ω 0805
C8	CC 102P/25V 0805	R6	R 43Ω 1206
C9	CC 222P/100V 1206	R7, R7A	R 2Ω 1206
C10, C11	EC 470u/16V 105°C	R8	R 51KΩ 1206
C12	CC 222P/16V 0805	R9	NTC R 12KΩ 0805
D2	Diode FR107	R10	R 22Ω 1206
D3	Diode FR102	R12	R 820Ω 0805
D4	Diode 1N4148_SOD-123	R13	R 2.2KΩ 0805
D5	Diode SB2040_TO-220F	R14	R 1KΩ 0805
F1	Fuse 2A/250VAC	R15, R16	R 22KΩ 0805 ±1%
L1	10μH 6mm	R17	R 330KΩ 0805 ±1%
		R18	R 220Ω 1206
		T1	EE-22
		U1	IC UTC UC3873A
		U2	TL431
		U3	PC817B

■ TYPICAL CHARACTERISTICS

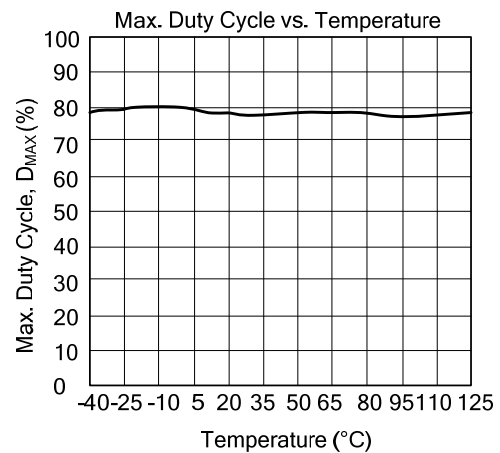
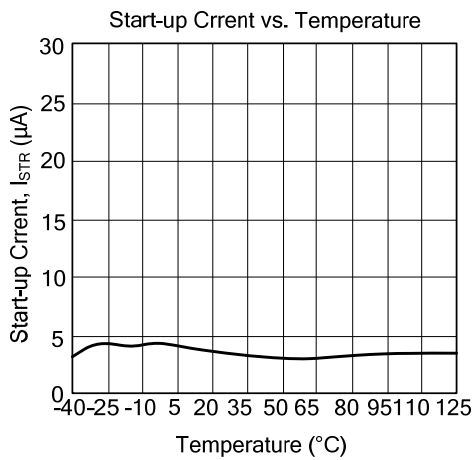
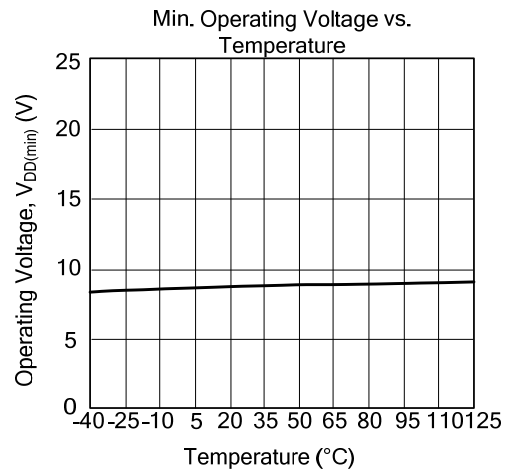
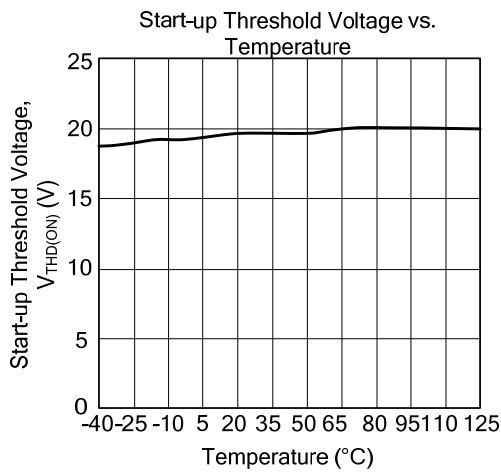
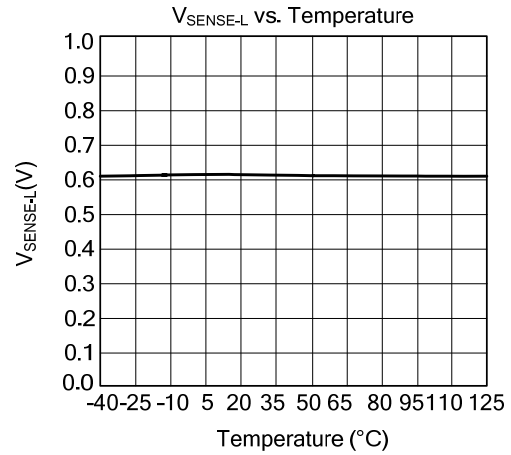
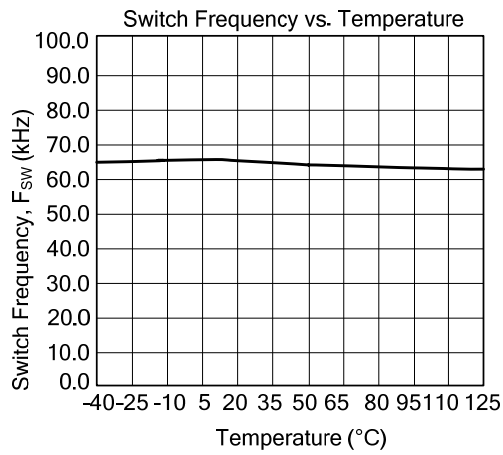

UTC assumes no responsibility for equipment failures that result from using products at values that exceed, even momentarily, rated values (such as maximum ratings, operating condition ranges, or other parameters) listed in products specifications of any and all UTC products described or contained herein. UTC products are not designed for use in life support appliances, devices or systems where malfunction of these products can be reasonably expected to result in personal injury. Reproduction in whole or in part is prohibited without the prior written consent of the copyright owner. The information presented in this document does not form part of any quotation or contract, is believed to be accurate and reliable and may be changed without notice.