



UK3018

Power MOSFET

2.5V DRIVE SILICON N-CHANNEL MOSFET

DESCRIPTION

The UTC **UK3018** is a Silicon N-channel MOSFET, designed to minimize on-state resistance while it provides rugged, reliable and fast switching performance. The product is particularly suited for low voltage and low current applications such as small servo motor controllers, power MOSFET gate drivers, and other switching applications.

FEATURES

- * Min $V_{DSS} = 30V$
- * $R_{DS(ON)} \leq 8.0 \Omega @ V_{GS}=4.0V, I_D=10mA$
 $R_{DS(ON)} \leq 13 \Omega @ V_{GS}=2.5V, I_D=1.0mA$
- * Pulsed $I_D=400mA$
- * Low voltage drive (2.5V)

SYMBOL

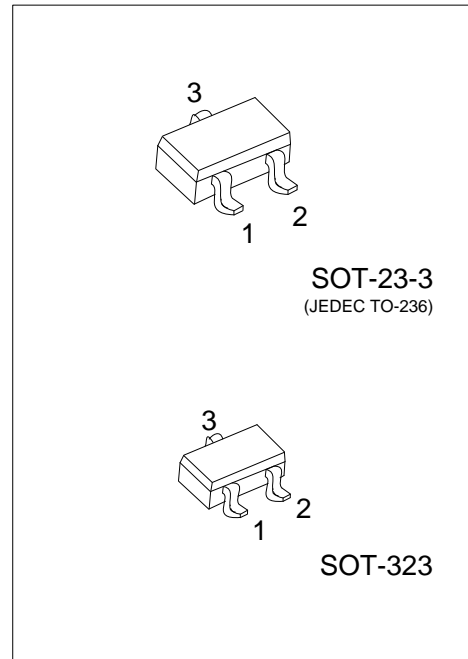
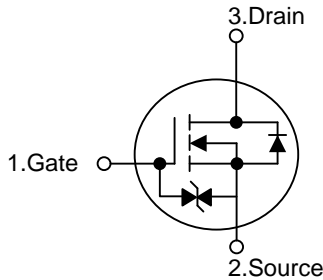

ORDERING INFORMATION

Ordering Number		Package	Pin Assignment			Packing
Lead Free	Halogen Free		1	2	3	
UK3018L-AE2-R	UK3018G-AE2-R	SOT-23-3	G	S	D	Tape Reel
UK3018L-AL3-R	UK3018G-AL3-R	SOT-323	G	S	D	Tape Reel

Note: Pin Assignment: G: Gate S: Source D: Drain

	<p>(1) R: Tape Reel</p> <p>(2) AE2: SOT-23-3, AL3: SOT-323</p> <p>(3) G: Halogen Free and Lead Free, L: Lead Free</p>
--	---

MARKING

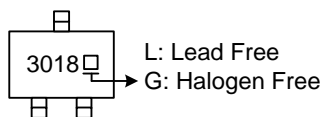

■ ABSOLUTE MAXIMUM RATING (T_A=25°C, unless otherwise specified)

PARAMETER		SYMBOL	RATINGS	UNIT
Drain-Source Voltage		V _{DSS}	30	V
Gate-Source Voltage		V _{GSS}	+20	V
			-12	V
Drain Current	Continuous	I _D	100	mA
	Pulsed (Note 2)	I _{DP}	400	mA
Power Dissipation (Note 3)		P _D	200	mW
Junction Temperature		T _J	+150	°C
Storage Temperature		T _{STG}	-55 ~ +150	°C

Notes: 1. Absolute maximum ratings are those values beyond which the device could be permanently damaged.

Absolute maximum ratings are stress ratings only and functional device operation is not implied.

2. Pw≤10μs, Duty cycle≤1%.

3. With each pin mounted on the recommended lands.

■ THERMAL DATA

PARAMETER	SYMBOL	RATINGS	UNIT
Junction to Ambient	θ _{JA}	625	°C/W

■ ELECTRICAL CHARACTERISTICS (T_A=25°C, unless otherwise specified)

PARAMETER	SYMBOL	TEST CONDITIONS	MIN	TYP	MAX	UNIT
OFF CHARACTERISTICS						
Drain-Source Breakdown Voltage	BV _{DSS}	V _{GS} =0V, I _D =10μA	30			V
Drain-Source Leakage Current	I _{DSS}	V _{DS} =30V, V _{GS} =0V			1	μA
Gate-Source Leakage Current	I _{GSS}	V _{DS} =0V, V _{GS} =+20V			1	μA
		V _{DS} =0V, V _{GS} =-12V			-1	μA
ON CHARACTERISTICS						
Gate Threshold Voltage	V _{GS(TH)}	V _{DS} =3V, I _D =100μA	0.8		1.5	V
Static drain-source on-state resistance	R _{DS(ON)}	V _{GS} =4V, I _D =10mA		5	8	Ω
		V _{GS} =2.5V, I _D =1mA		7	13	Ω
DYNAMIC PARAMETERS						
Input capacitance	C _{ISS}	V _{DS} = 5V, V _{GS} = 0V, f = 1MHz		13		pF
Output capacitance	C _{OSS}			9		pF
Reverse transfer capacitance	C _{RSS}			4		pF
SWITCHING PARAMETERS						
Turn-ON Delay Time	t _{D(ON)}	V _{GS} = 5V, V _{DD} ≈5V I _D = 10mA, R _L = 500Ω, R _G = 10Ω		15		ns
Turn-ON Rise Time	t _R			35		ns
Turn-OFF Delay Time	t _{D(OFF)}			80		ns
Turn-OFF Fall-Time	t _F			80		ns

■ TEST CIRCUITS AND WAVEFORMS

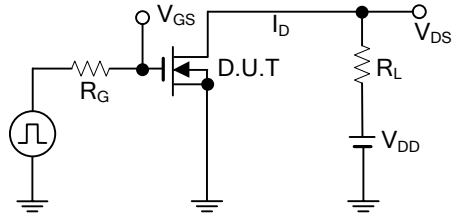

Switching Time Measurement Circuit

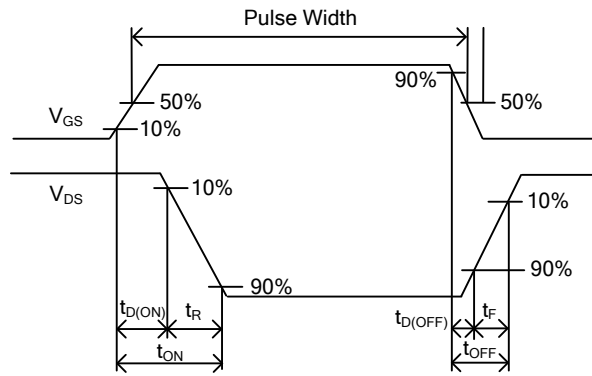

Switching Time Waveforms

■ TYPICAL CHARACTERISTICS

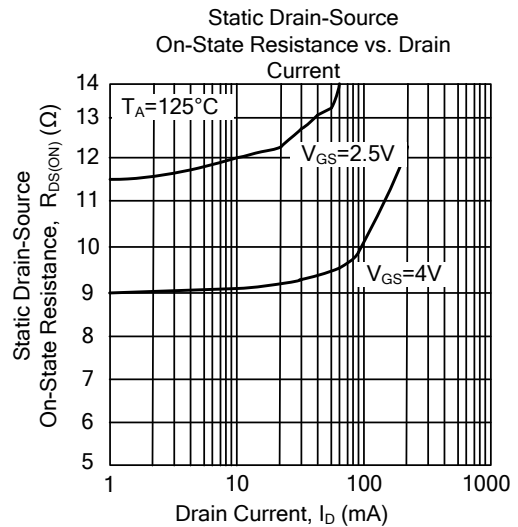
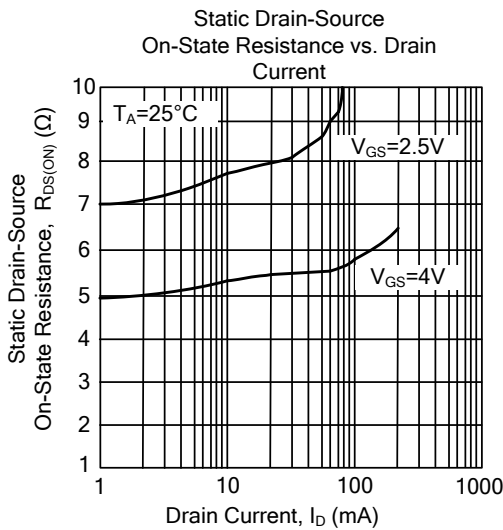
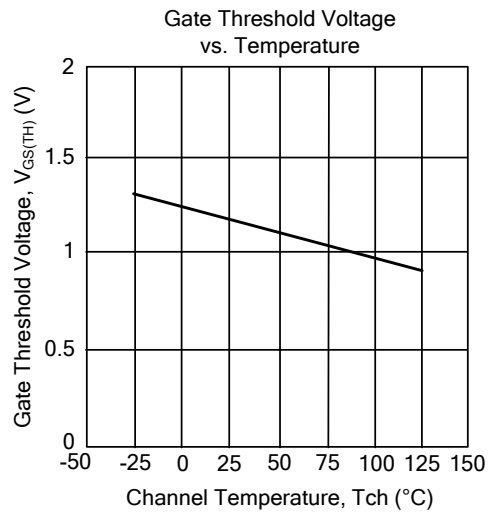
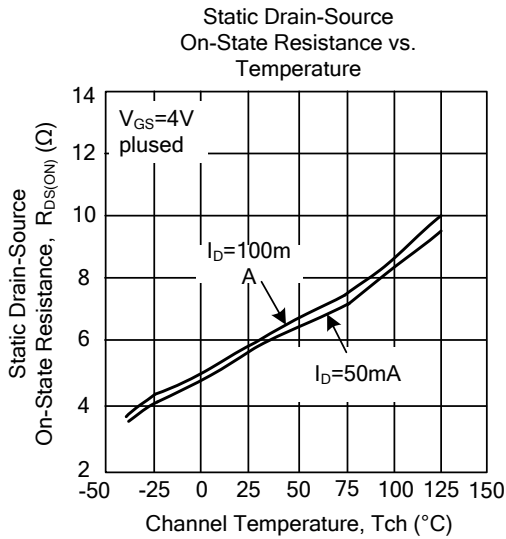
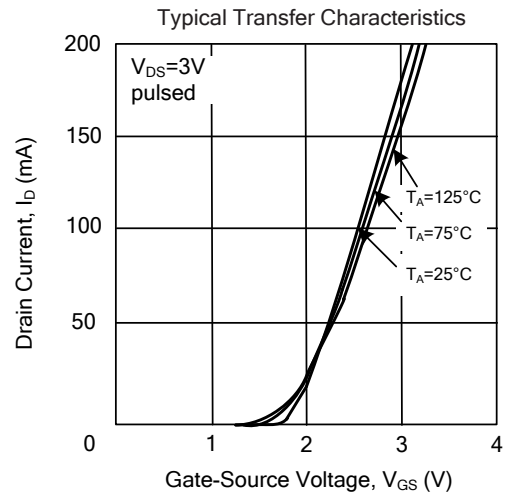
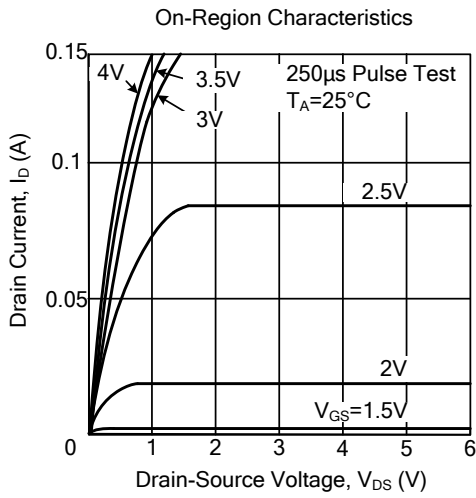

■ TYPICAL CHARACTERISTICS (Cont.)

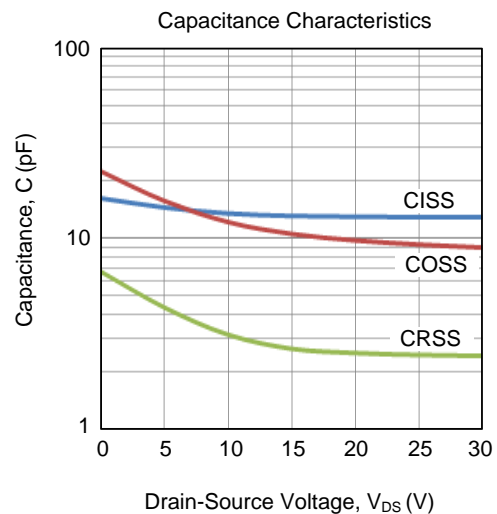
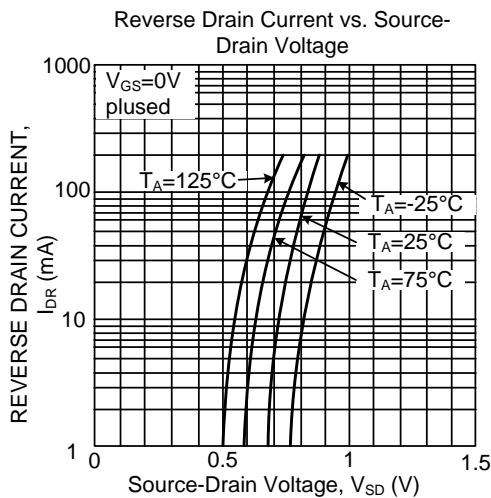
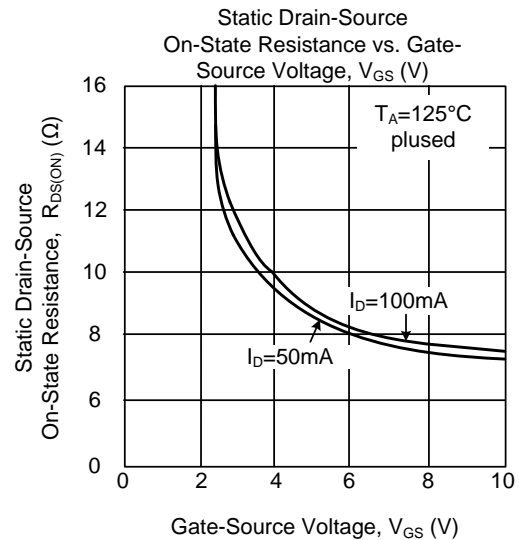
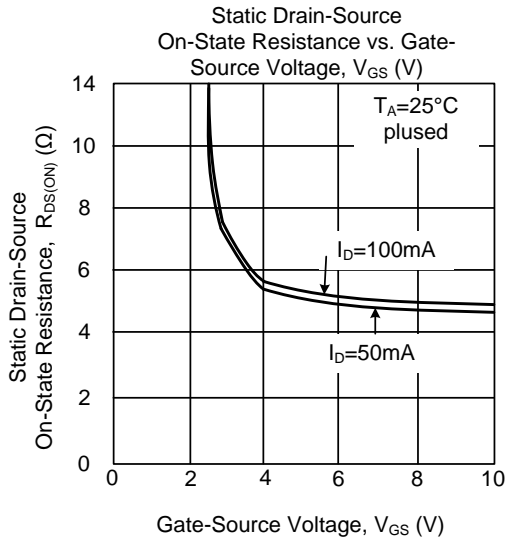
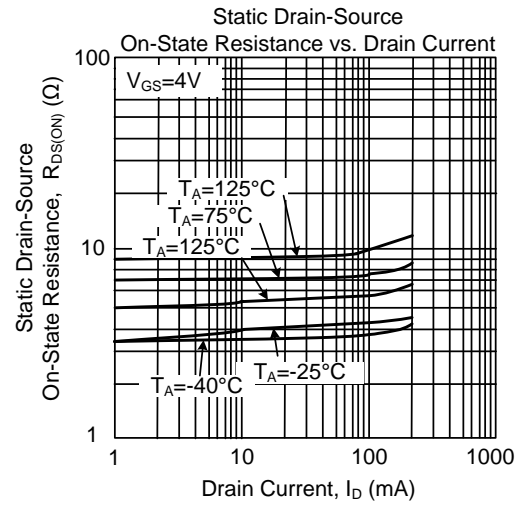
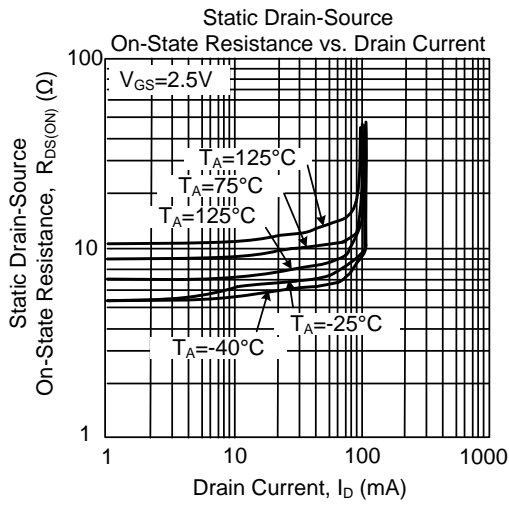

UTC assumes no responsibility for equipment failures that result from using products at values that exceed, even momentarily, rated values (such as maximum ratings, operating condition ranges, or other parameters) listed in products specifications of any and all UTC products described or contained herein. UTC products are not designed for use in life support appliances, devices or systems where malfunction of these products can be reasonably expected to result in personal injury. Reproduction in whole or in part is prohibited without the prior written consent of the copyright owner. UTC reserves the right to make changes to information published in this document, including without limitation specifications and product descriptions, at any time and without notice. This document supersedes and replaces all information supplied prior to the publication hereof.