



ULN2803

LINEAR INTEGRATED CIRCUIT

EIGHT DARLINGTON ARRAYS

■ DESCRIPTION

The UTC **ULN2803** is high-voltage, high-current Darlington drivers comprised of eight NPN Darlington pairs.

■ FEATURES

- *Output current (single output) 500mA MAX.
- *High sustaining voltage output 50V MIN.
- *Output clamp diodes
- *Inputs compatible with various types of logic

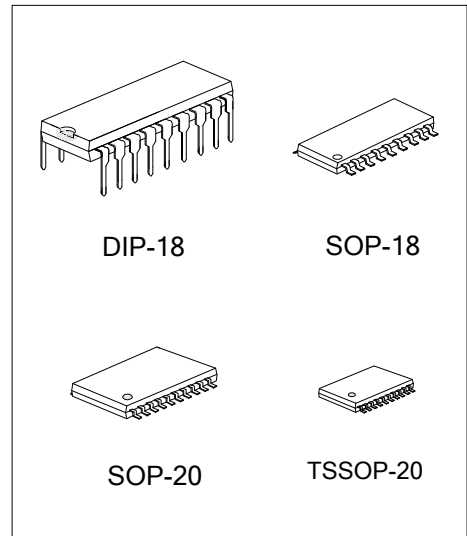

■ ORDERING INFORMATION

Ordering Number		Package	Packing
Lead Free	Halogen Free		
ULN2803L-D18-T	ULN2803G-D18-T	DIP-18	Tube
ULN2803L-S18-R	ULN2803G-S18-R	SOP-18	Tape Reel
ULN2803L-S20-R	ULN2803G-S20-R	SOP-20	Tape Reel
ULN2803L-P20-R	ULN2803G-P20-R	TSSOP-20	Tape Reel

<p>ULN2803G-D18-T</p> <p>(1) Packing Type (2) Package Type (3) Green Package</p>	<p>(1) T: Tube, R: Tape Reel (2) D18: DIP-18, S18: SOP-18, S20: SOP-20 P20: TSSOP-20 (3) G: Halogen Free and Lead Free</p>
--	--

■ MARKING

PACKAGE	MARKING
DIP-18	<p>Date Code L: Lead Free G: Halogen Free Lot Code</p>
SOP-18	<p>Date Code L: Lead Free G: Halogen Free Lot Code</p>
SOP-20 TSSOP-20	<p>Date Code L: Lead Free G: Halogen Free Lot Code</p>

PIN CONFIGURATIONS

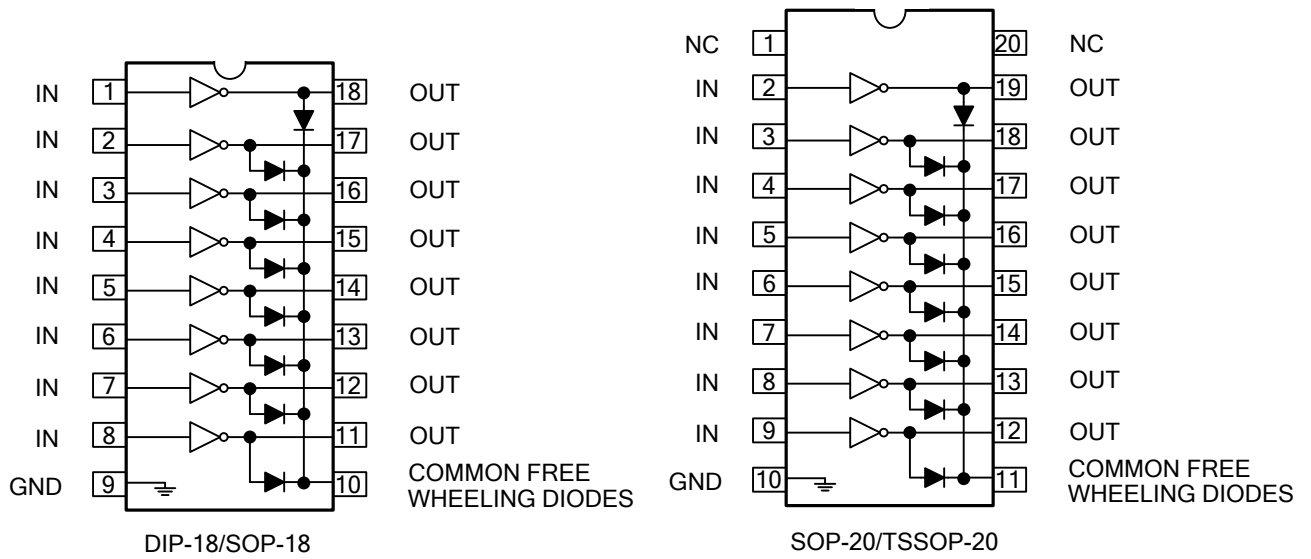

SCHEMATICS (EACH DRIVER)

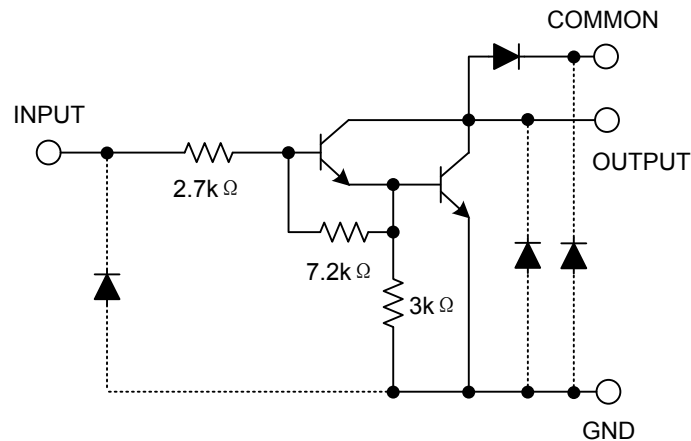

Note: The input and output parasitic diodes cannot be used as clamp diodes.

■ ABSOLUTE MAXIMUM RATINGS

PARAMETER		SYMBOL	RATINGS	UNIT
Input Voltage		V_{IN}	-0.5~30	V
Output Sustaining Voltage		$V_{CE(SUS)}$	-0.5~50	V
Output Current		I_{OUT}	500	mA/ch
Clamp Diode Reverse Voltage		V_R	50	V
Clamp Diode Forward Current		I_F	500	mA
Power Dissipation	DIP-18	P_D	1.47	W
	SOP-18		0.54/0.625(Note)	
	SOP-20		0.56	
	TSSOP-20		0.52	
Operating Temperature		T_{OPR}	-40 ~ +85	°C
Storage Temperature		T_{STG}	-40 ~ +150	°C

Notes: 1. On glass epoxy PCB (30x30x1.6mm Cu 50%)

2. Absolute maximum ratings are stress ratings only and functional device operation is not implied. The device could be damaged beyond Absolute maximum ratings.

■ ELECTRICAL CHARACTERISTICS ($T_A=25^\circ\text{C}$, unless otherwise specified)

PARAMETER		SYMBOL	TEST CIRCUIT	TEST CONDITIONS	MIN	TYP	MAX	UNIT
Output Leakage Current		I_{CEX}	1	$V_{CE}=50\text{V}, T_A=25^\circ\text{C}$ $V_{CE}=50\text{V}, T_A=85^\circ\text{C}$			50 100	μA
Collector-Emitter Saturation Voltage		$V_{CE(SAT)}$	2	$I_{OUT}=350\text{mA}, I_{IN}=500\mu\text{A}$ $I_{OUT}=200\text{mA}, I_{IN}=350\mu\text{A}$ $I_{OUT}=100\text{mA}, I_{IN}=250\mu\text{A}$		1.3 1.1 0.9	1.6 1.3 1.1	V
Input Current	ON	$I_{IN(ON)}$	3	$V_{IN}=3.85\text{V}, I_{OUT}=350\text{mA}$		0.93	1.35	mA
	OFF	$I_{IN(OFF)}$	4	$I_{OUT}=500\mu\text{A}, T_A=85^\circ\text{C}$	50	65		μA
Input Voltage (output on)		$V_{IN(ON)}$	5	$V_{CE}=2.0\text{V}$ $I_{OUT}=200\text{mA}$ $I_{OUT}=250\text{mA}$ $I_{OUT}=300\text{mA}$			2.4 2.7 3.0	V
Clamp Diode Reverse Current		I_R	6	$V_R=50\text{V}, T_A=25^\circ\text{C}$ $V_R=50\text{V}, T_A=85^\circ\text{C}$			50 100	μA
Clamp Diode Forward Voltage		V_F	7	$I_F=350\text{mA}$			2.0	V
Input Capacitance		C_{IN}				15	25	pF
Turn-On Delay		t_{ON}	8	$V_{OUT}=50\text{V}, R_L=125\Omega, C_L=15\text{pF}$		0.1	1	μs
Turn-Off Delay		t_{OFF}	8	$V_{OUT}=50\text{V}, R_L=125\Omega, C_L=15\text{pF}$		0.2	1	μs

■ TEST CIRCUIT

1. I_{CEX}

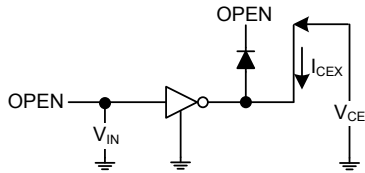

2. $V_{CE(sat)}$, h_{FE}

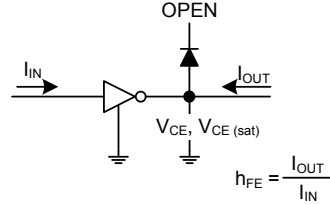

3. $I_{IN(ON)}$

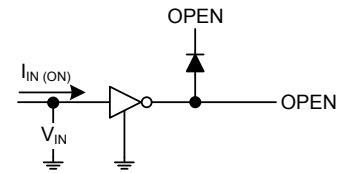

4. $I_{IN(OFF)}$

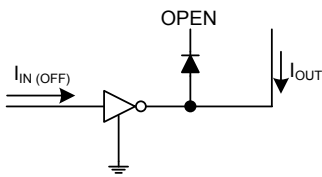

5. $V_{IN(ON)}$

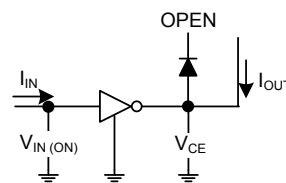

6. I_R

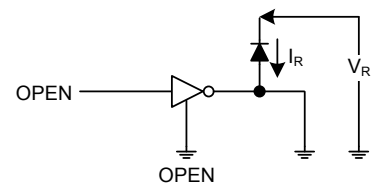

7. V_F

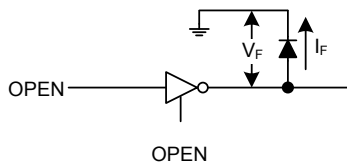

8. t_{ON} , t_{OFF}

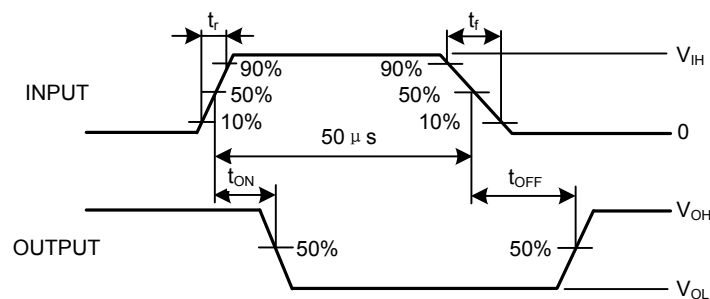
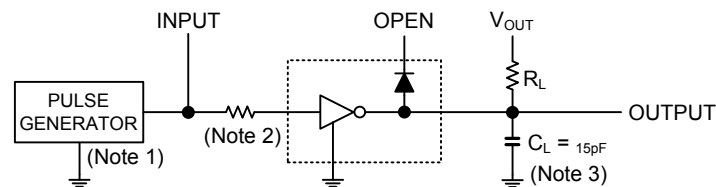

- Notes: 1. Pulse width $50\mu s$, duty cycle 10%
 Output impedance 50Ω , $t_r \leq 5ns$, $t_f \leq 10ns$
 2. $R_L: 0$, $V_{IH}: 3V$
 3. C_L includes probe and jig capacitance.

TYPICAL CHARACTERISTICS

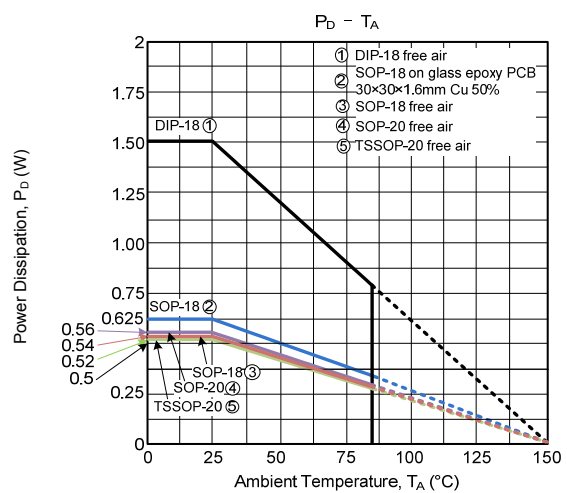
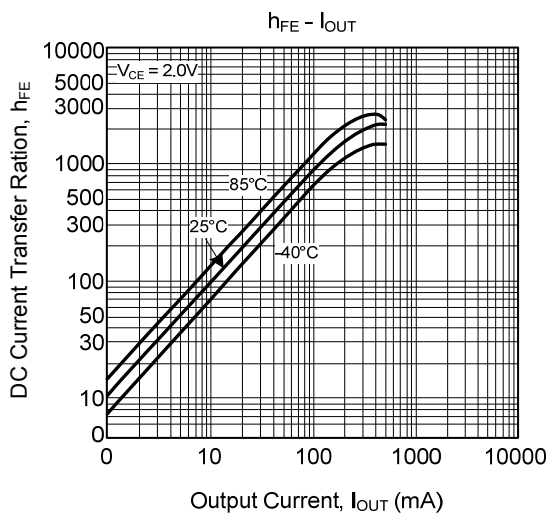
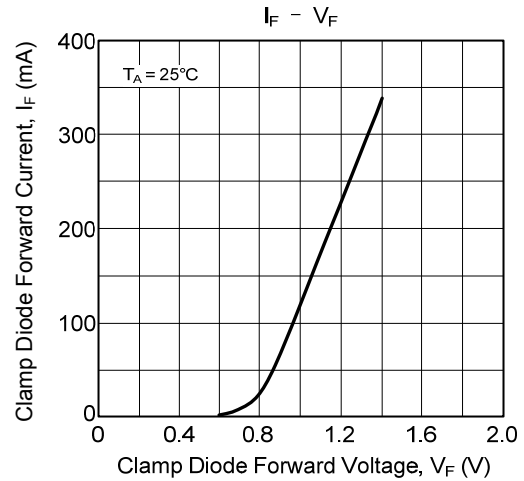
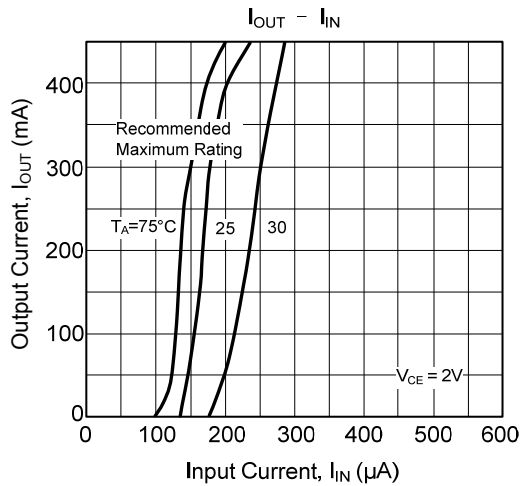
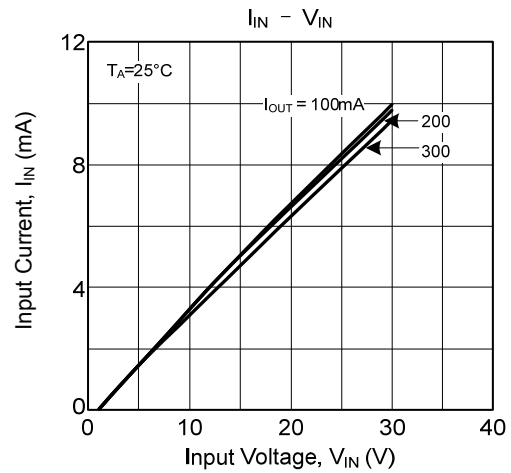
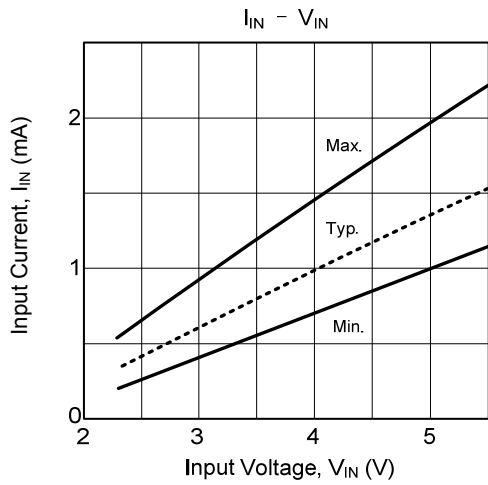

UTC assumes no responsibility for equipment failures that result from using products at values that exceed, even momentarily, rated values (such as maximum ratings, operating condition ranges, or other parameters) listed in products specifications of any and all UTC products described or contained herein. UTC products are not designed for use in life support appliances, devices or systems where malfunction of these products can be reasonably expected to result in personal injury. Reproduction in whole or in part is prohibited without the prior written consent of the copyright owner. UTC reserves the right to make changes to information published in this document, including without limitation specifications and product descriptions, at any time and without notice. This document supersedes and replaces all information supplied prior to the publication hereof.