

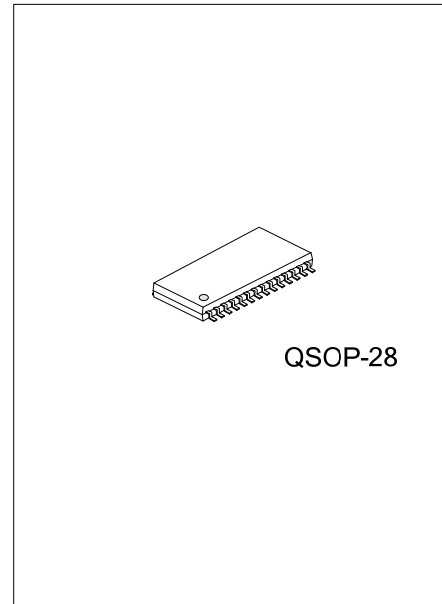

URCZ1284-XX

LINEAR INTEGRATED CIRCUIT

PARALLEL PORT SINGLE TERMINATION NETWORK WITH $\pm 15KV$ ESD PROTECTION



DESCRIPTION

The UTC **URCZ1284-XX** is a high-speed parallel port single termination .Here is two basic cells in the integrated termination, Cell 1 and Cell 2(See Fig1 &Fig 2). The UTC **URCZ1284-XX** contains the proper termination for 8 data lines, 1 strobe line, 4 control lines and 4 statut lines; The UTC **URCZ1284-XX** has an extra protection against ESD.

The UTC **URCZ1284-XX** is ideally suitable for Notebooks, PC Peripherals, Servers and Desktops, etc.

FEATURES

- * Highly integrated termination
- * EMI noise filtering
- * RFI noise filtering
- * Withstand ± 8 kV contact-discharge

ORDERING INFORMATION

Ordering Number		Package	Packing
Lead Free	Halogen Free		
URCZ1284L-XX-SQ8-T	URCZ1284G-XX-SQ8-T	QSOP-28	Tube
URCZ1284L-XX- SQ8-R	URCZ1284G-XX-SQ8-R	QSOP-28	Tape & Reel

<p>URCZ1284L-XX-SQ8-T</p> <ul style="list-style-type: none"> (1) Packing Type (2) Package Type (3) Resistance Code (4) Green Package 	<ul style="list-style-type: none"> (1) T: Tube, R: Tape Reel (2) SQ8: QSOP-28 (3) Code: 01, 02, 03 (4) L: Lead Free, G: Halogen Free and Lead Free
--	--

MARKING

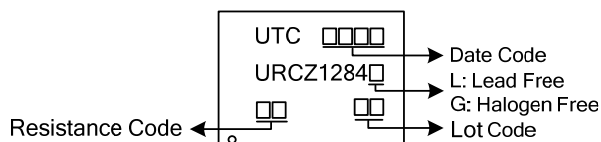

■ PIN CONFIGURATION

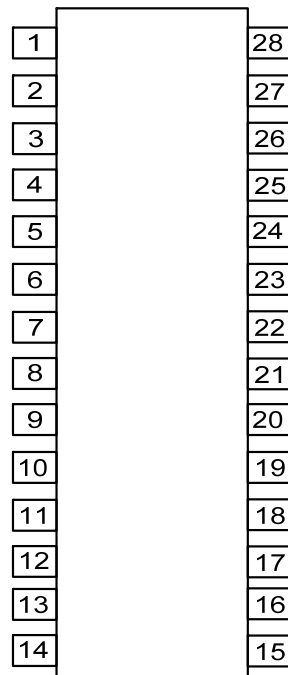

■ PIN DESCRIPTION

PIN NO.	PIN NAME	DESCRIPTION
1	Select in	Terminal of Select input
2	Error	Terminal of Error
3	Strobe	Input of Strobe(before EMI filtering)
4	Bit 1	Input of Bit 1 (before EMI filtering)
5	Bit 2	Input of Bit 2 (before EMI filtering)
6	Bit 3	Input of Bit 3 (before EMI filtering)
7	Bit 4	Input of Bit 4 (before EMI filtering)
8	Acknowledge	Terminal of Acknowledge
9	Bit 5	Input of Bit 5 (before EMI filtering)
10	Paper out	Terminal of Paper out
11	Bit 6	Input of Bit 6 (before EMI filtering)
12	Busy	Terminal of Busy
13	Bit 7	Input of Bit 7 (before EMI filtering)
14	Bit 8	Input of Bit 8 (before EMI filtering)
15	Select paper	Terminal of Select paper
16	Bit 8'	Output of Bit 8 (after EMI filtering)
17	Bit 7'	Output of Bit 7 (after EMI filtering)
18	Bit 6'	Output of Bit 6 (after EMI filtering)
19	Bit 5'	Output of Bit 5 after EMI filtering)
20	Vcc	Supply Voltage
21	Bit 4'	Output of Bit 4 (after EMI filtering)
22	Gnd	Ground
23	Bit 3'	Output of Bit 3 (after EMI filtering)
24	Bit 2'	Output of Bit 2 (after EMI filtering)
25	Bit 1'	Output of Bit 1 (after EMI filtering)
26	Strobe'	Output of Strobe (after EMI filtering)
27	Autofeed	Terminal of Autofeed
28	Reset	Terminal of Reset

■ BLOCK DIAGRAM

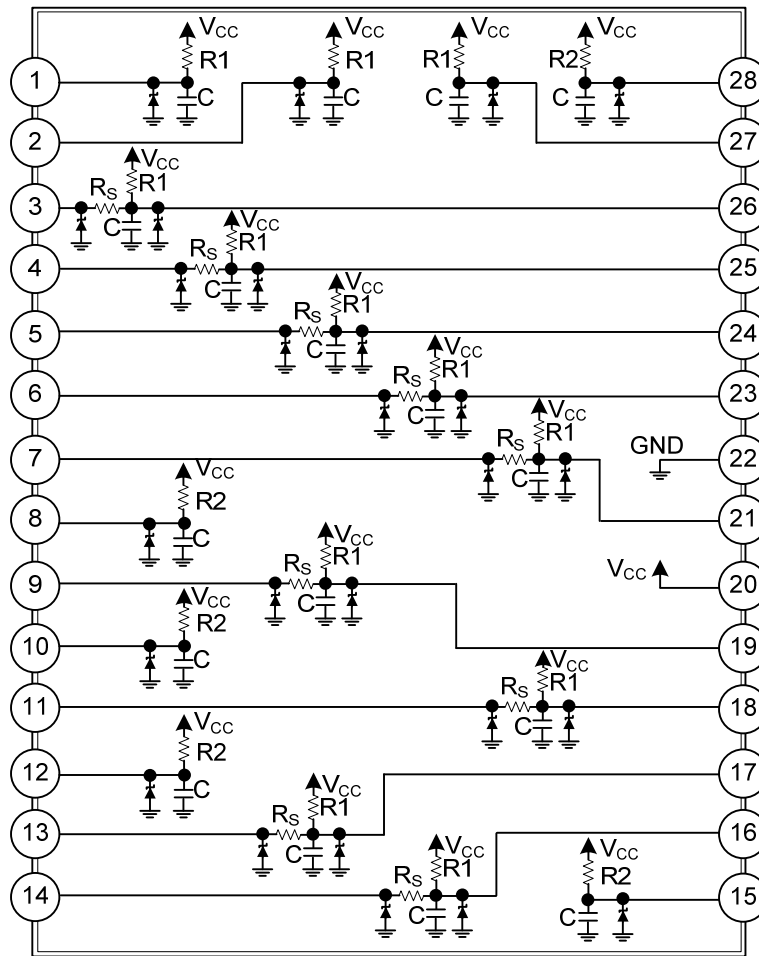

NO	R1	R2	Rs	C
Code 01	4.7KΩ	4.7KΩ	33Ω	180pF
Code 02	2.2KΩ	2.2KΩ	33Ω	220pF
Code 03	1KΩ	5.1KΩ	39Ω	150pF

■ ABSOLUTE MAXIMUM RATING ($T_A=25^{\circ}\text{C}$, unless otherwise specified.)

PARAMETER	SYMBOL	RATINGS	UNIT
Supply Voltage	V_{CC}	5.5	V
Power Rating Per Resistor	P_R	100	mW
Package POWER Rating	P_P	1	W
Maximum Operating Junction Temperature	T_J	125	$^{\circ}\text{C}$
Operating Temperature Range	T_{OPR}	0 ~ +70	$^{\circ}\text{C}$
Storage Temperature Range	T_{STG}	-55 ~ +150	$^{\circ}\text{C}$
ESD Discharge IEC61000-4-2, Contact Discharge	V_{PP}	± 8	KV

Note: Absolute maximum ratings are those values beyond which the device could be permanently damaged. Absolute maximum ratings are stress ratings only and functional device operation is not implied.

■ ELECTRICAL CHARACTERISTICS ($T_A=25^{\circ}\text{C}$, unless otherwise specified.)

PARAMETER	SYMBOL	TEST CONDITIONS	MIN	TYP	MAX	UNIT
Leakage Current	I_R	$V_{CC}=5.0\text{V}$			10	μA
Breakdown Voltage	V_{BR}	$I_R=1\text{mA}$	6			V
Forward Voltage Drop	V_F	$I_F=50\text{mA}$		0.9		V

■ BASIC CELL CONFIGURATIONS

The UTC **URCZ1284-XX** is built around the two basic cells described by Fig 1 & Fig 2.

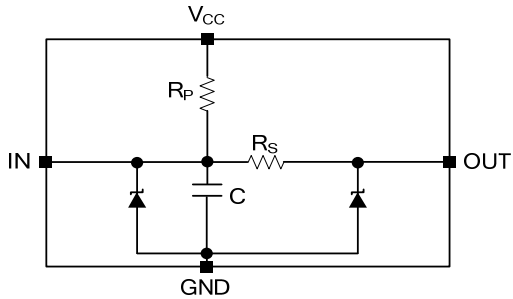

Fig 1. Cell 1 for line termination, EMI filtering and ESD protection for the Datalines and Strobe signals. There are 9 of these cells inside the UTC URCZ1284-XX

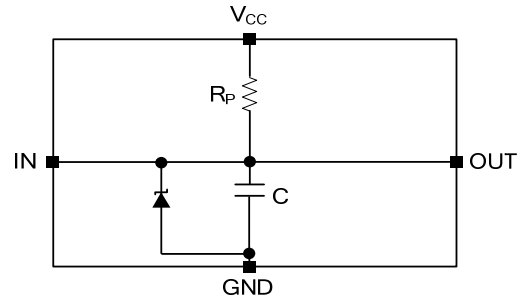
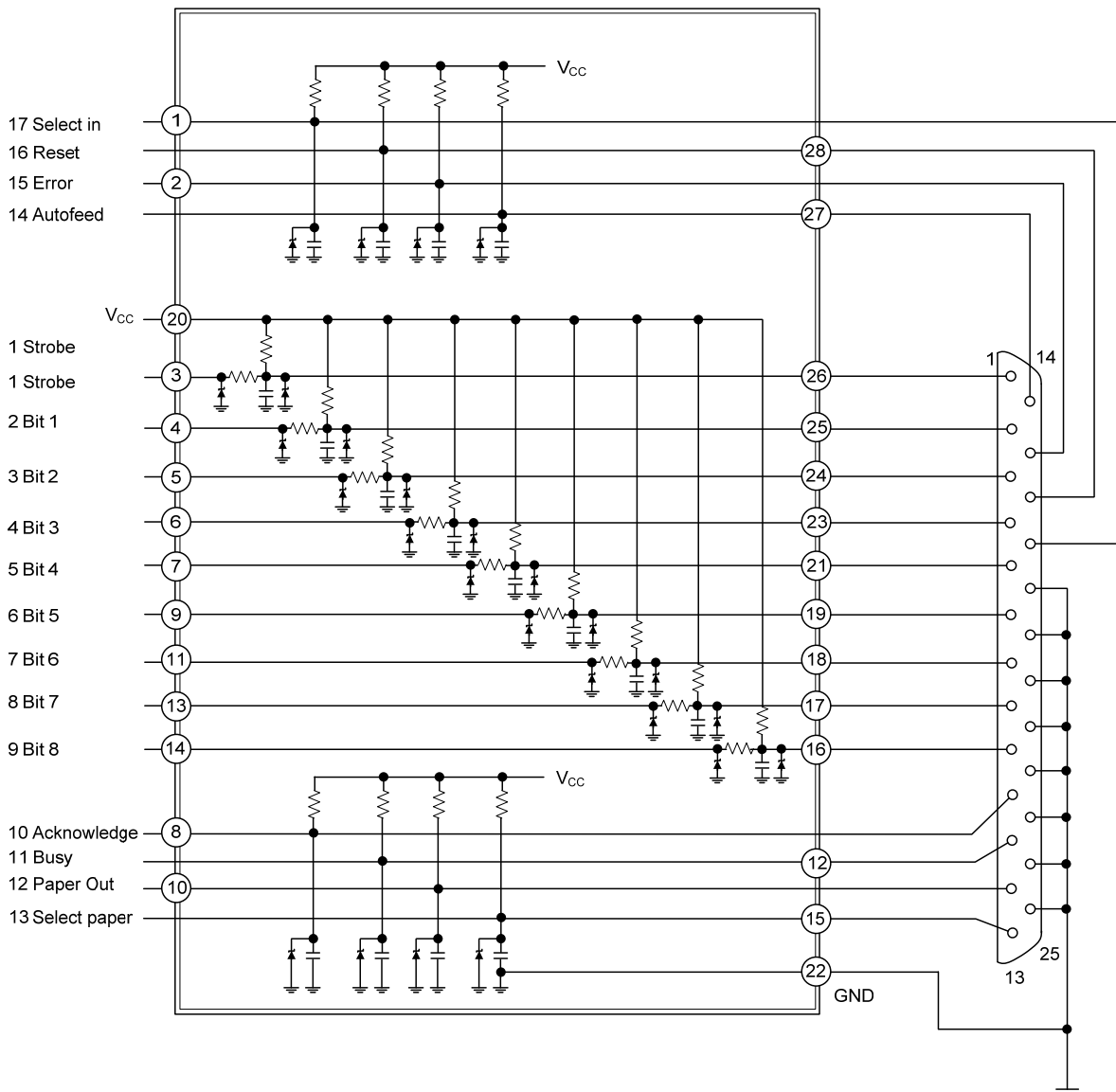

Fig 2. Cell 2 for EMI filtering and ESD protection of the Control and Status signals. There are 8 of these cells inside the UTC URCZ1284-XX

■ TYPICAL APPLICATION CIRCUIT



■ TYPICAL CHARACTERISTICS(Cont.)

UTC assumes no responsibility for equipment failures that result from using products at values that exceed, even momentarily, rated values (such as maximum ratings, operating condition ranges, or other parameters) listed in products specifications of any and all UTC products described or contained herein. UTC products are not designed for use in life support appliances, devices or systems where malfunction of these products can be reasonably expected to result in personal injury. Reproduction in whole or in part is prohibited without the prior written consent of the copyright owner. The information presented in this document does not form part of any quotation or contract, is believed to be accurate and reliable and may be changed without notice.