



## USRB01

Preliminary

LINEAR INTEGRATED CIRCUIT

### HIGH PRECISION CC/CV PRIMARY SIDE SWITCH

#### DESCRIPTION

The UTC **USRB01** is a primary controller for charger and adapter applications. The controlled variable is transferred by an auxiliary winding from the secondary to the primary side. The device uses Pulse Frequency Modulation (PFM) method to build discontinuous conduction mode (DCM) flyback power supplies.

The UTC **USRB01** operates in primary-side sensing and regulation. Opto-coupler and TL431 could be eliminated. It also eliminates the need of loop compensation circuitry while maintaining stability.

The UTC **USRB01** achieves high precision CV/CC regulation and high power efficiency. It offers comprehensive protection coverage with auto-recovery features including Cycle-by-cycle current limiting, output over voltage protection, V<sub>DD</sub> over voltage protection, feedback loop open protection, short circuit protection, leading edge blanking, OTP, V<sub>DD</sub> under voltage lockout, etc.

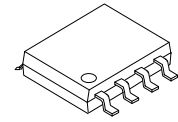

SOP-8

#### FEATURES

- \* ±5% constant voltage regulation at universal AC input
- \* Primary side control without TL431 and opto-coupler
- \* High precision constant current regulation at universal AC input
- \* Programmable CV and CC regulation
- \* Eliminates control loop compensation circuitry
- \* Flyback topology in DCM operation
- \* Random frequency modulation to reduce system EMI
- \* Built-in power NPN
- \* Programmable cable drop compensation
- \* Built-in leading edge blanking
- \* Built-in primary winding inductance compensation
- \* Open circuit protection
- \* Output over voltage protection
- \* V<sub>DD</sub> over voltage protection
- \* Short circuit protection
- \* Over temperature protection

#### ORDERING INFORMATION

Ordering Number	Package	Packing
USRB01G-S08-R	SOP-8	Tape Reel

<p>USRB01G-S08-R</p> <ul style="list-style-type: none"> <li>(1)Packing Type</li> <li>(2)Package Type</li> <li>(3)Green Package</li> </ul>	<ul style="list-style-type: none"> <li>(1) R: Tape Reel</li> <li>(2) S08: SOP-8</li> <li>(3) G: Halogen Free and Lead Free</li> </ul>
---	---

#### MARKING

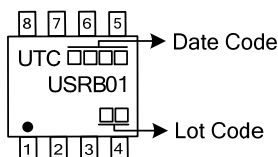

■ PIN CONFIGURATION

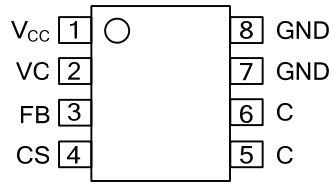

■ PIN DESCRIPTION

PIN NO.	PIN NAME	DESCRIPTION
1	V <sub>CC</sub>	Power supply
2	VC	Low pass filter capacitor for cable compensation
3	FB	The voltage feedback from the auxiliary winding
4	CS	Current sense input
5~6	C	The collector of the power NPN
7~8	GND	Ground

■ BLOCK DIAGRAM

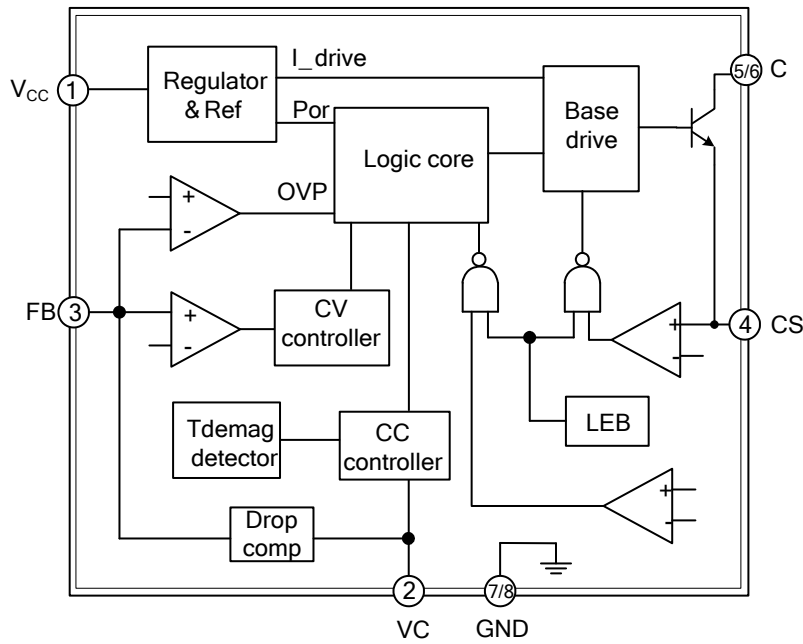

### ■ ABSOLUTE MAXIMUM RATING

PARAMETER	SYMBOL	RATINGS	UNIT
V <sub>DD</sub> Voltage		-0.3~30	V
VC Voltage		-0.3~7	V
C Voltage		-0.3~700	V
CS Input Voltage		-0.3~7	V
FB Input Voltage		-0.3~7	V
Junction Temperature	T <sub>J</sub>	-40~150	°C
Storage Temperature	T <sub>STG</sub>	-55~150	°C
Lead Temperature (Soldering, 10 secs)	T <sub>OPR</sub>	260	°C

Note: Absolute maximum ratings are those values beyond which the device could be permanently damaged. Absolute maximum ratings are stress ratings only and functional device operation is not implied.

### ■ THERMAL DATA

PARAMETER	SYMBOL	RATINGS	UNIT
Junction to Ambient	$\theta_{JC}$	150	°C/W

### ■ ELECTRICAL CHARACTERISTICS (T<sub>A</sub>=25°C, V<sub>DD</sub>=15V, if not otherwise noted)

PARAMETER	SYMBOL	TEST CONDITIONS	MIN	TYP	MAX	UNIT
<b>Supply Voltage (V<sub>DD</sub>) Section</b>						
Start up Current	I <sub>ST</sub>	V <sub>DD</sub> =11V		1	3	μA
Static Current	I <sub>OP</sub>	V <sub>DD</sub> =15V		300	400	μA
Turn-off Threshold Voltage	V <sub>TH(OFF)</sub>		6.0	6.8	7.6	V
Turn-on Threshold Voltage	V <sub>TH(ON)</sub>		11.5	12.5	13.5	V
V <sub>DD</sub> Over Protect Voltage	V <sub>DD_OVP</sub>		25	27	29	V
Operating Voltage					25	V
<b>Current Sense Input Section</b>						
LEB Time	T <sub>LEB</sub>			2.5		μS
Over Current Threshold	V <sub>CS</sub>		470	500	520	mV
OCP Propagation Delay	T <sub>D_OC</sub>	From OCP Comparator to Base Drive		200		nS
<b>FB Input Section</b>						
Reference Voltage for Feedback Threshold	V <sub>FB</sub>		1.98	2.00	2.02	V
Maximum Cable Compensation Current	I <sub>cable</sub>		47	52	56	μA
<b>Power BJT Section</b>						
Collector-emitter breakdown voltage	V <sub>CEO</sub>	I <sub>C</sub> =10mA, I <sub>B</sub> =0	450			V
Collect Peak Current	I <sub>C</sub>			0.6		A
Collector-Base Breakdown Voltage	V <sub>CB0</sub>	I <sub>C</sub> =10mA	700			V
<b>On Chip Over Temperature Section</b>						
Over Temperature Protection	T <sub>otp</sub>			150		°C

### ■ OPERATION DESCRIPTION

The UTC **USRB01** is a primary control unit for switch mode charger and adapter applications. It operates in primary-side sensing and regulation. Opto-coupler and TL431 could be eliminated. Proprietary built-in CV and CC control can achieve high precision CV/CC performance. It uses Pulse Frequency Modulation (PFM) method to build discontinuous conduction mode (DCM) flyback power supplies.

#### Startup control

The  $V_{DD}$  pin of UTC **USRB01** is connected to the line input through a resistor. A large value startup resistor can be used to minimize the power loss in application because the start current of UTC **USRB01** is very low. When the  $V_{DD}$  voltage reaches  $V_{TH(ON)}$ , the internal startup circuit is disabled and the IC turns on.

#### Operating Current

The Operating current of UTC **USRB01** is as low as 400 $\mu$ A. Good efficiency and very low standby power can be achieved.

#### Constant Voltage Operation

The output voltage is defined by the transmission ratio between the secondary and auxiliary winding. The UTC **USRB01** captures the auxiliary winding feedback voltage at FB pin and operates in constant-voltage (CV) mode to regulate the output voltage. The auxiliary voltage reflects the output voltage is given by:

$$V_{AUX} = \frac{N_A}{N_S} \times (V_O + \Delta V) \tag{1}$$

Where  $\Delta V$  indicates the drop voltage of the output diode.

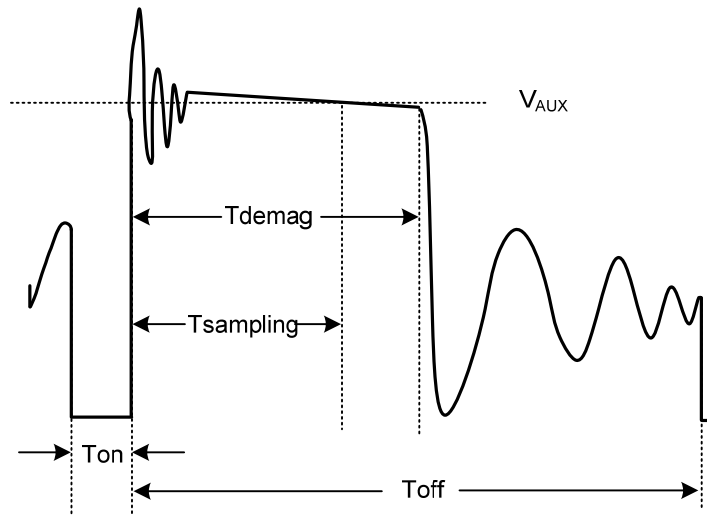

Figure 2. Auxiliary voltage waveform

Via a resistor divider connected between the auxiliary winding and FB, the  $V_{AUX}$  is sampled at the  $T_{sampling}$  end and it is hold until the next sampling. The sampled voltage is compared with 2V reference voltage and the error is amplified. The error amplifier output reflects the load condition and controls the  $T_{off}$  time to regulate the output voltage, thus constant output voltage can be achieved.

#### Constant Current Operation

When the sampled voltage is below 2V reference voltage and the error amplifier output reaches its maximum, thus UTC **USRB01** operates in constant-current (CC) mode. The CC point and maximum output power can be externally adjusted by external current sense resistor  $R_{cs}$ . The larger  $R_{cs}$ , the smaller CC point is, and the smaller output power becomes.

■ OPERATION DESCRIPTION (Cont.)

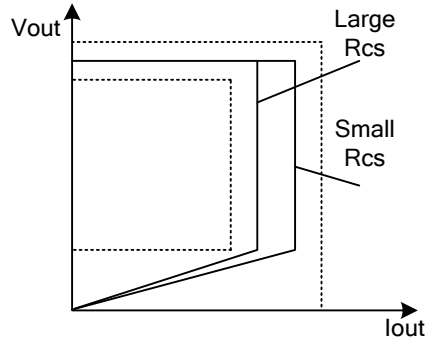

Figure3. Adjustable output power by changing Rcs

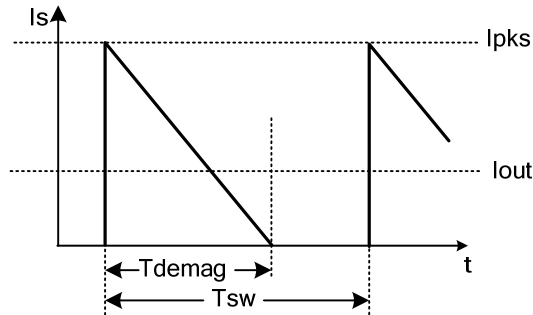

Figure4. Secondary current waveform

In CC operation, the CC loop control function of UTC **USRB01** will keep a fixed proportion between secondary inductance de-magnetization time (Tdemag) and switching cycle time (Tsw). The fixed proportion is

$$\frac{T_{demag}}{T_{sw}} = \frac{1}{2} \tag{2}$$

Thus the output current is given by:

$$I_{out} = \frac{1}{2} \times \frac{N_p}{N_s} \times I_{PK} \times \frac{T_{demag}}{T_{sw}} = \frac{1}{4} \times \frac{N_p}{N_s} \times I_{PK} \tag{3}$$

**Programmable Cable drop Compensation**

UTC **USRB01** has a built-in cable voltage drop compensation to achieve good load regulation. An offset voltage is generated at FB pin by an internal current flowing into the resistor divider. The current is inversely proportional to the voltage of VC pin. As a result, it is inversely proportional to the output load current. The voltage drop across the cable is compensated by this offset voltage at FB pin. It can also be programmed by adjusting the resistance of the divider to compensate the drop for various cable lines used.

**Current Sensing and Leading Edge Blanking**

Cycle-by-cycle current limiting is offered in UTC **USRB01**. The switch current is detected by a sense resistor into the CS pin. When the power switch is turned on, a turn-on spike will occur on this resistor. A 500ns leading-edge blanking is built in to avoid false-termination of the switching pulse so that the external RC filtering is no longer needed.

## ■ OPERATION DESCRIPTION (Cont.)

**Drive BJT**

The driver is a push pull stage with the supply voltage  $V_{DD}$ . It provides the driving current for the external power bipolar transistor. The output signal is current-limited to  $I_{OUT(SOURCE)}$ .

**Protection Control**

Good power supply system reliability is achieved with its comprehensive protection features including  $V_{DD}$  over voltage protection, OTP, feedback loop open protection, Cycle-by-cycle current limiting, short circuit protection, leading edge blanking and UVLO, etc.

$V_{DD}$  is supplied by transformer auxiliary winding output. The output of UTC **USRB01** is shutdown when  $V_{DD}$  drops below  $V_{TH(OFF)}$  and the power converter enters power on start-up sequence thereafter.

