



UT06P03

Power MOSFET

P-CHANNEL ENHANCEMENT MODE

■ DESCRIPTION

The **UT06P03** is P-Channel Power MOSFET, designed with high density cell with fast switching speed, ultra low on-resistance, excellent thermal and electrical capabilities.

■ SYMBOL

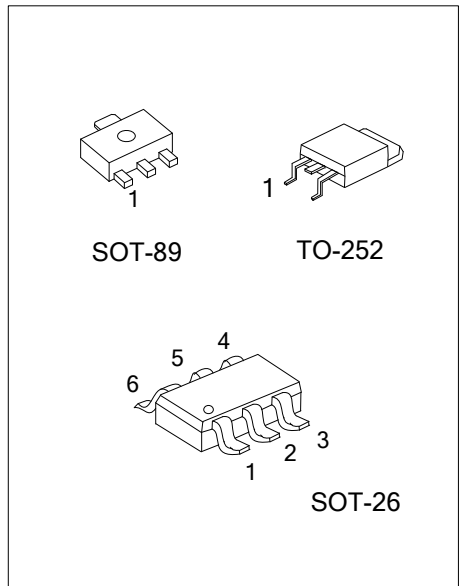
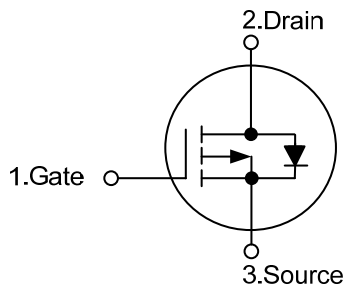

■ ORDERING INFORMATION

Ordering Number		Package	Pin Assignment						Packing
Lead Free	Halogen Free		1	2	3	4	5	6	
-	UT06P03G-AB3-R	SOT-89	G	D	S	-	-	-	Tape Reel
-	UT06P03G-AG6-R	SOT-26	D	D	G	S	D	D	Tape Reel
UT06P03L-TN3-R	UT06P03G-TN3-R	TO-252	G	D	S	-	-	-	Tape Reel

Note: Pin Assignment: G: Gate D: Drain S: Source

<p>UT06P03G-AB3-R</p>	<p>(1) R: Tape Reel, T: Tube (2) AB3: SOT-89, AG6: SOT-26, TN3: TO-252 (3) G: Halogen Free and Lead Free, L: Lead Free</p>
-----------------------	--

■ MARKING

SOT-89	SOT-26	TO-252

■ ABSOLUTE MAXIMUM RATINGS ($T_C = 25^\circ\text{C}$, unless otherwise specified)

PARAMETER		SYMBOL	RATINGS	UNIT
Drain-Source Voltage		V_{DSS}	-30	V
Gate-Source Voltage		V_{GSS}	± 20	V
Continuous Drain Current		I_D	-4	A
Pulsed Drain Current (Note 1, 2)		I_{DM}	-20	A
Total Power Dissipation ($T_A = 25^\circ\text{C}$)	SOT-89	P_D	0.78	W
	SOT-26		0.41	W
	TO-252		1	W
Junction Temperature		T_J	+150	$^\circ\text{C}$
Storage Temperature		T_{STG}	-55 ~ +150	$^\circ\text{C}$

Note: Absolute maximum ratings are those values beyond which the device could be permanently damaged.

Absolute maximum ratings are stress ratings only and functional device operation is not implied.

■ THERMAL DATA

PARAMETER		SYMBOL	MAX	UNIT
Junction to Ambient	SOT-89	θ_{JA}	160	$^\circ\text{C/W}$
	SOT-26		300	$^\circ\text{C/W}$
	TO-252		110	$^\circ\text{C/W}$
Junction to Case	SOT-89	θ_{JC}	18	$^\circ\text{C/W}$
	SOT-26		110	$^\circ\text{C/W}$
	TO-252		7.93	$^\circ\text{C/W}$

■ ELECTRICAL CHARACTERISTICS (T_c =25°C, unless otherwise noted)

PARAMETER	SYMBOL	TEST CONDITIONS	MIN	TYP	MAX	UNIT
OFF CHARACTERISTICS						
Drain-Source Breakdown Voltage	BV _{DSS}	V _{GS} =0 V, I _D =-250μA	-30			V
Drain-Source Leakage Current	I _{DSS}	V _{DS} =-24V, V _{GS} =0 V			1	μA
Gate-Source Leakage Current	I _{GSS}	V _{DS} =0 V, V _{GS} = ±20V			±100	nA
ON CHARACTERISTICS						
Gate Threshold Voltage	V _{GS(TH)}	V _{DS} =V _{GS} , I _D =-250 μA	-0.9	-1.5	-3	V
Drain-Source On-State Resistance (Note 2)	R _{DS(ON)}	V _{GS} =-4.5V, I _D =-3A		60	75	mΩ
		V _{GS} =-10V, I _D =-4A		37	45	
DYNAMIC PARAMETERS						
Input Capacitance	C _{ISS}	V _{DS} =-15V, V _{GS} =0V, f=1MHz		530		pF
Output Capacitance	C _{OSS}			135		
Reverse Transfer Capacitance	C _{RSS}			70		
SWITCHING PARAMETERS						
Turn-ON Delay Time (Note 2)	t _{D(ON)}	V _{GS} =-10V, V _{DS} =-15V, R _G =6Ω, I _D =-1A		5.7		ns
Turn-ON Rise Time	t _R			10		
Turn-OFF Delay Time	t _{D(OFF)}			18		
Turn-OFF Fall Time	t _F			5		
Total Gate Charge (Note 2)	Q _G	V _{DS} =0.5BV _{DSS} , V _{GS} =-10V, I _D =-4A		10	14	nC
Gate-Source Charge	Q _{GS}			2.2		
Gate-Drain Charge	Q _{GD}			2		
SOURCE-DRAIN DIODE RATINGS AND CHARACTERISTICS						
Drain-Source Diode Forward Voltage	V _{SD}	I _F = -1A, V _{GS} = 0V			-1.2	V
Maximum Body-Diode Continuous Current	I _S				-2.1	A
Maximum Pulsed Drain-Source Diode Forward Current (Note 1)	I _{SM}				-4	
Reverse Recovery Time	t _{RR}	I _F =-4 A, dI _F /dt=100A/μs		15.5		ns
Recovery Charge	Q _{RR}				7.9	

- Notes: 1. Pulse width limited by T_{J(MAX)}
 2. Pulse width ≤300us, duty cycle ≤2%.
 3. Surface mounted on 1 in² copper pad of FR4 board.

TYPICAL CHARACTERISTICS

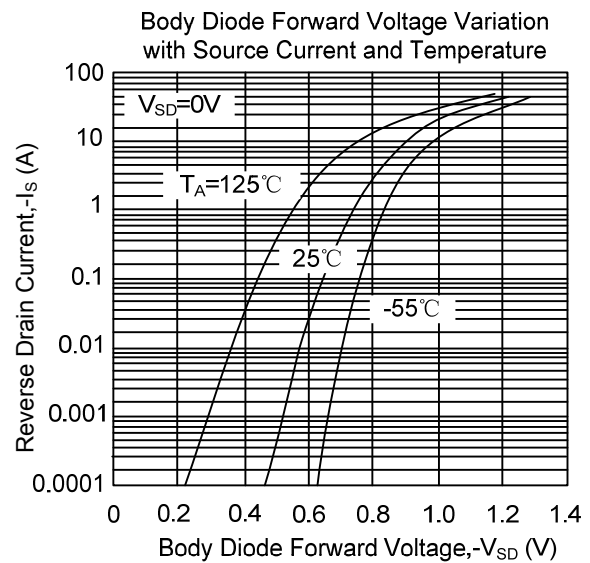
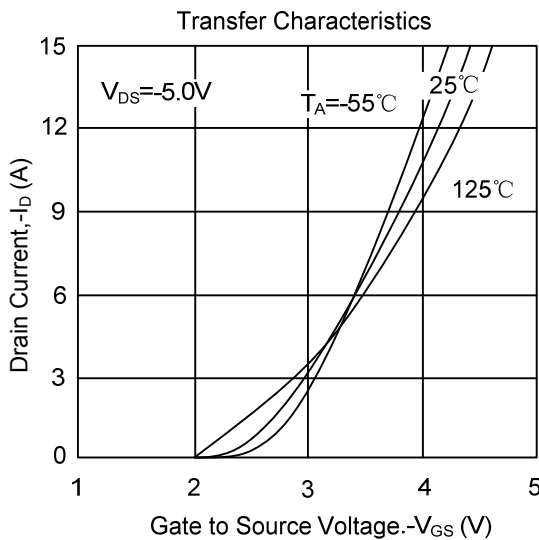
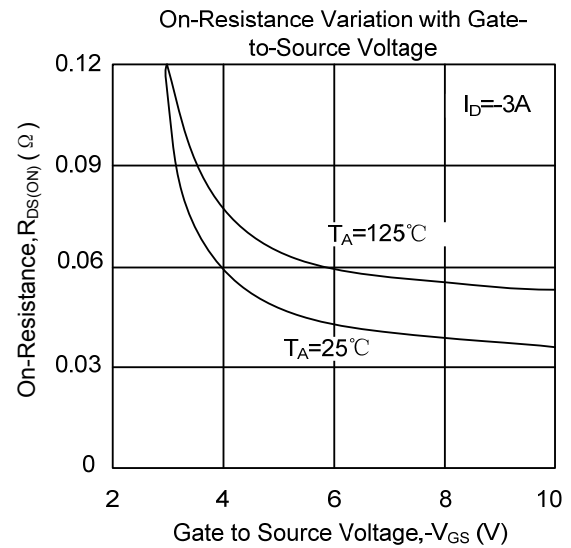
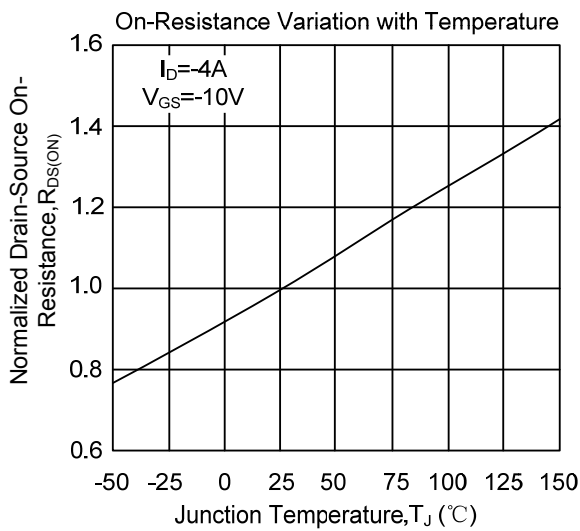
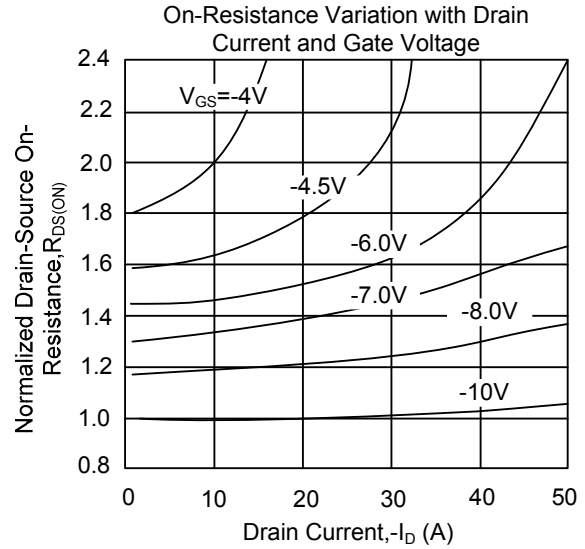
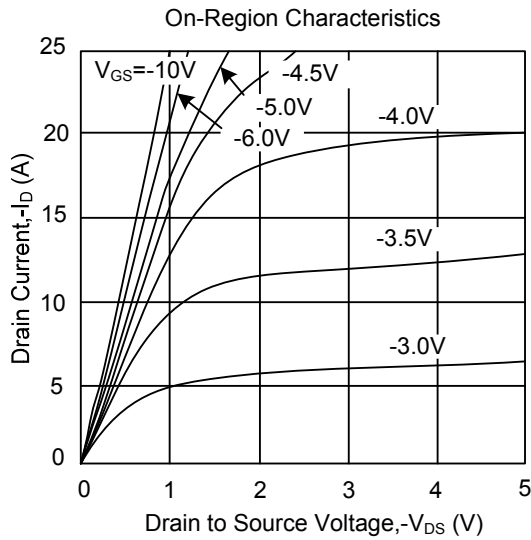

■ TYPICAL CHARACTERISTICS(Cont.)

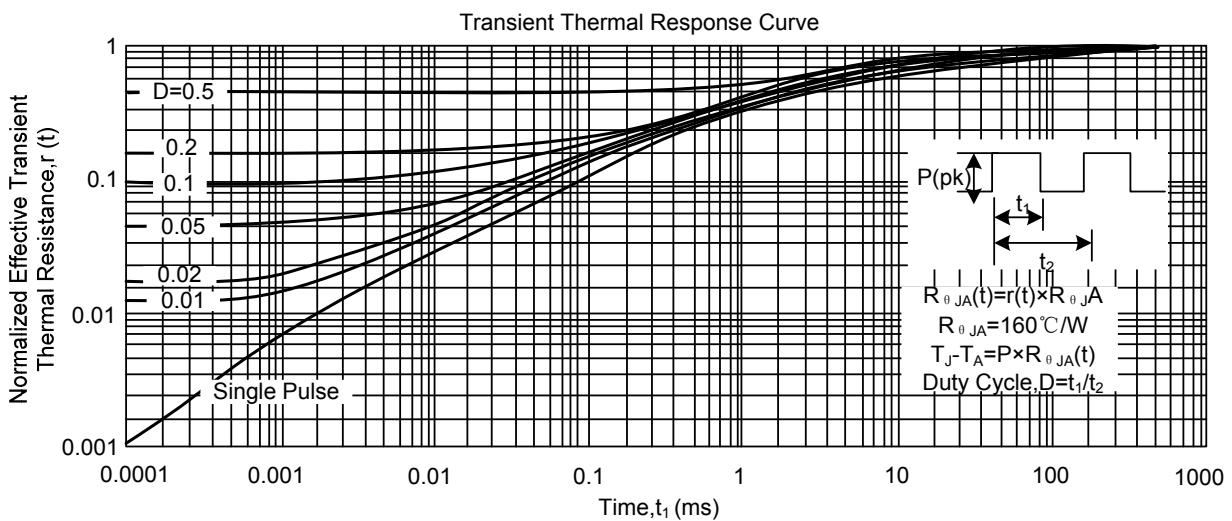
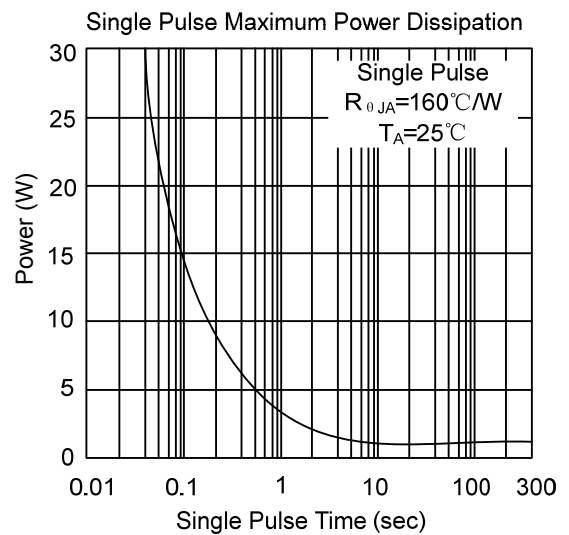
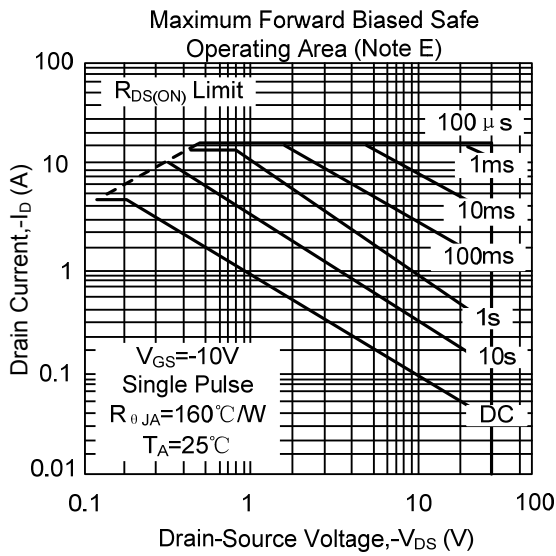
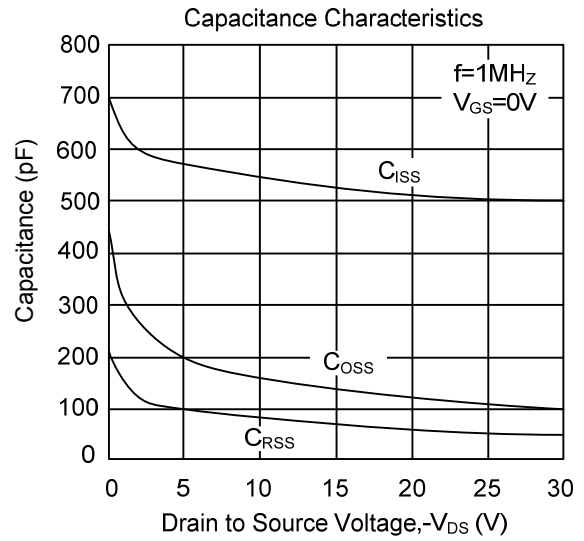
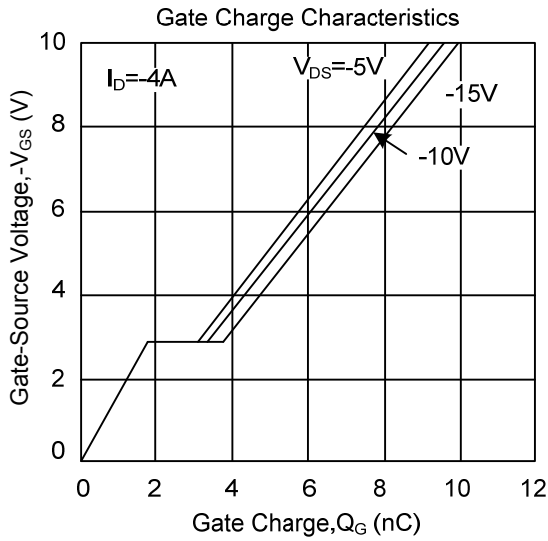

UTC assumes no responsibility for equipment failures that result from using products at values that exceed, even momentarily, rated values (such as maximum ratings, operating condition ranges, or other parameters) listed in products specifications of any and all UTC products described or contained herein. UTC products are not designed for use in life support appliances, devices or systems where malfunction of these products can be reasonably expected to result in personal injury. Reproduction in whole or in part is prohibited without the prior written consent of the copyright owner. The information presented in this document does not form part of any quotation or contract, is believed to be accurate and reliable and may be changed without notice.