



UT108N03

Power MOSFET

30V, 108A N-CHANNEL POWER MOSFET

■ DESCRIPTION

As advanced N-channel level power MOSFET, the **UT108N03** is produced using UTC's advanced trench technology, which has been specially tailored to minimize the on-resistance and maintain low gate charge for superior switching performance.

■ FEATURES

- * $R_{DS(ON)} < 5.3m\Omega @ V_{GS} = 10V, I_D = 25A$
- * Low Capacitance
- * Optimized Gate Charge
- * Fast Switching Capability
- * Avalanche Energy Specified

■ SYMBOL

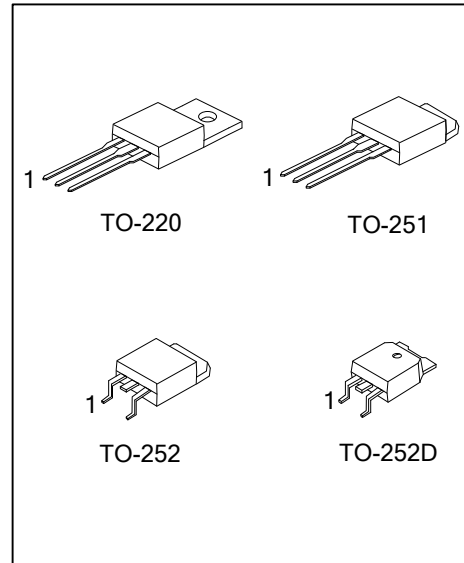
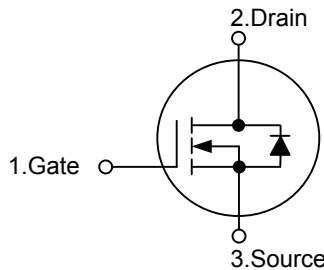

■ ORDERING INFORMATION

Ordering Number		Package	Pin Assignment			Packing
Lead Free	Halogen Free		1	2	3	
UT108N03L-TA3-T	UT108N03G-TA3-T	TO-220	G	D	S	Tube
UT108N03L-TM3-T	UT108N03G-TM3-T	TO-251	G	D	S	Tube
UT108N03L-TN3-R	UT108N03G-TN3-R	TO-252	G	D	S	Tape Reel
UT108N03L-TND-R	UT108N03G-TND-R	TO-252D	G	D	S	Tape Reel

Note: Pin Assignment: G: Gate D: Drain S: Source

<p>UT108N03L-TA3-T</p>	<p>(1) R: Tape Reel, T: Tube</p> <p>(2) TA3: TO-220, TM3: TO-251, TN3: TO-252</p> <p>TND: TO-252D</p> <p>(3) L: Lead Free, G: Halogen Free and Lead Free</p>
------------------------	--

■ MARKING

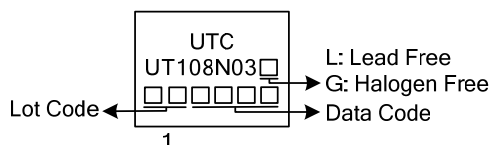

■ ABSOLUTE MAXIMUM RATINGS ($T_J=25^\circ\text{C}$, unless otherwise specified)

PARAMETER		SYMBOL	RATINGS	UNIT
Drain-Source Voltage		V_{DSS}	30	V
Gate-Source Voltage		V_{GSS}	± 20	V
Drain Current		I_D	108	A
Pulsed Drain Current (Note 2)		I_{DM}	432	A
Avalanche Energy (Note 3)		E_{AS}	580	mJ
Power Dissipation	TO-220	P_D	107	W
	TO-251/TO-252		60	
	TO-252D			
Junction Temperature		T_J	+150	$^\circ\text{C}$
Storage Temperature		T_{STG}	-55 ~ +150	$^\circ\text{C}$

Notes: 1. Absolute maximum ratings are those values beyond which the device could be permanently damaged. Absolute maximum ratings are stress ratings only and functional device operation is not implied.

2. $t_p \leq 10\mu\text{s}$, pulsed, $T_A=25^\circ\text{C}$

3. $V_{GS}=10\text{V}$, $T_J=25^\circ\text{C}$, $I_D=35\text{A}$, $V_S \leq 25\text{V}$, $t_p=0.25\text{ms}$, $R_{GS}=50\Omega$

■ THERMAL DATA

PARAMETER		SYMBOL	RATINGS	UNIT
Junction to Ambient	TO-220	θ_{JA}	62.5	$^\circ\text{C/W}$
	TO-251/TO-252		100	$^\circ\text{C/W}$
	TO-252D			
Junction to Case	TO-220	θ_{JC}	1.4	$^\circ\text{C/W}$
	TO-251/TO-252		2.5	$^\circ\text{C/W}$
	TO-252D			

■ ELECTRICAL CHARACTERISTICS (T_J =25°C, unless otherwise specified)

PARAMETER	SYMBOL	TEST CONDITIONS	MIN	TYP	MAX	UNIT
OFF CHARACTERISTICS						
Drain-Source Breakdown Voltage	BV _{DSS}	V _{GS} =0V, I _D =250μA	30			V
Drain-Source Leakage Current	I _{DSS}	V _{DS} =30V, V _{GS} =0V		0.05	1	μA
Gate-Source Leakage Current	I _{GSS}	V _{DS} =0V, V _{GS} =±20V		0.02	100	nA
ON CHARACTERISTICS						
Gate Threshold Voltage	V _{GS(TH)}	V _{DS} =V _{GS} , I _D =1mA	1		3	V
Static Drain-Source On-Resistance	R _{DS(ON)}	V _{GS} =10V, I _D =25A		4.2	5.3	mΩ
		V _{GS} =5V, I _D =25A			6.6	mΩ
DYNAMIC PARAMETERS						
Input Capacitance	C _{ISS}	V _{DS} =25V, V _{GS} =0V, f=1.0MHz		2900		pF
Output Capacitance	C _{OSS}			500		pF
Reverse Transfer Capacitance	C _{RSS}			350		pF
SWITCHING PARAMETERS						
Turn-ON Delay Time	t _{D(ON)}	V _{DD} =15V, R _G =10Ω, V _{GS} =5V, R _D =0.6Ω, I _D =1A		60		ns
Turn-ON Rise Time	t _R			100		ns
Turn-OFF Delay Time	t _{D(OFF)}			650		ns
Turn-OFF Fall-Time	t _F			300		ns
Total Gate Charge	Q _G	V _{DD} =15V, V _{GS} =5V, I _D =40A		310		nC
Gate Source Charge	Q _{GS}			50		nC
Gate Drain Charge	Q _{GD}			90		nC
SOURCE- DRAIN DIODE RATINGS AND CHARACTERISTICS						
Drain-Source Diode Forward Voltage	V _{SD}	I _S =108A, V _{GS} =0 V			1.25	V
Maximum Pulsed Drain-Source Diode Forward Current	I _{SM}	(Note)			432	A
Body Diode Reverse Recovery Time	t _{rr}	I _S =20A, di _S /dt=-100A/μs, V _{GS} =0V		34		ns
Body Diode Reverse Recovery Charge	Q _{RR}				27	

Note: t_p≤10μs, pulsed

TYPICAL CHARACTERISTICS

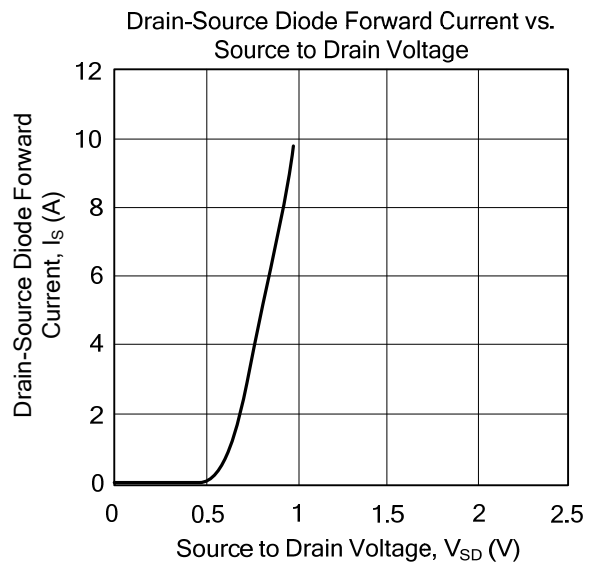
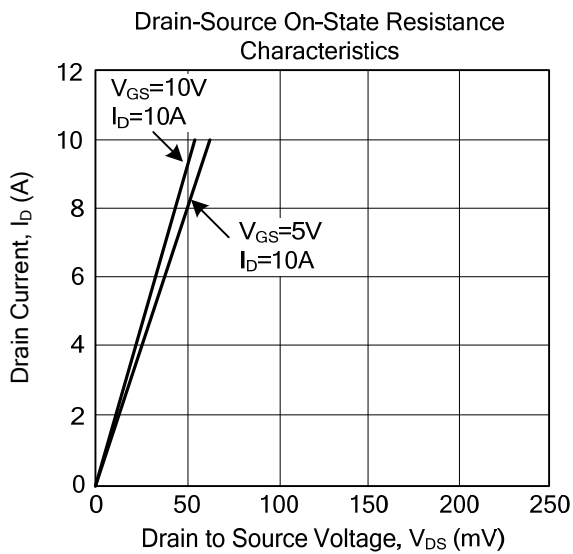
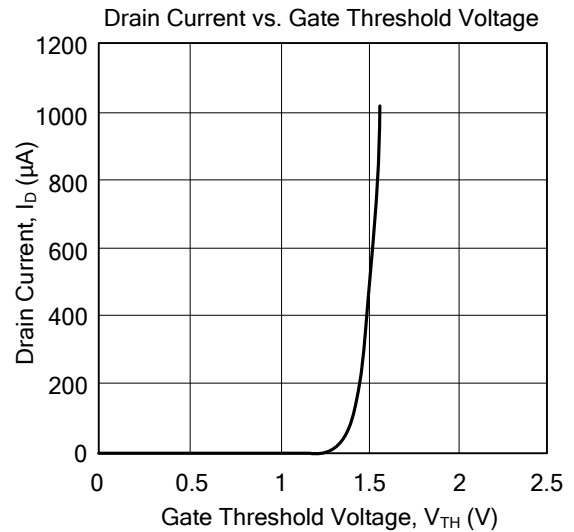
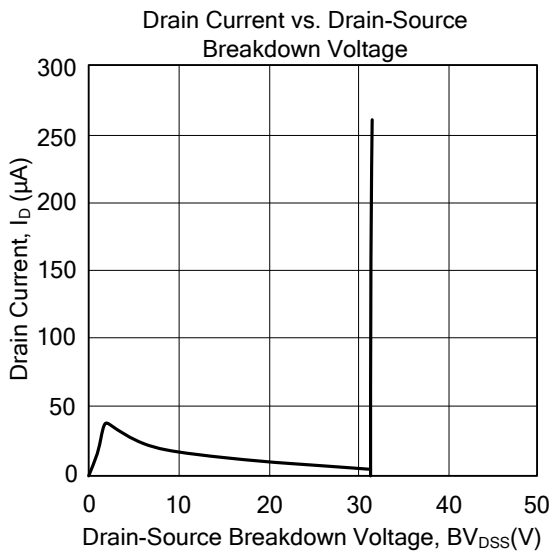

UTC assumes no responsibility for equipment failures that result from using products at values that exceed, even momentarily, rated values (such as maximum ratings, operating condition ranges, or other parameters) listed in products specifications of any and all UTC products described or contained herein. UTC products are not designed for use in life support appliances, devices or systems where malfunction of these products can be reasonably expected to result in personal injury. Reproduction in whole or in part is prohibited without the prior written consent of the copyright owner. The information presented in this document does not form part of any quotation or contract, is believed to be accurate and reliable and may be changed without notice.