



UT3401

Power MOSFET

P-CHANNEL ENHANCEMENT MODE

DESCRIPTION

The UTC **UT3401** is P-channel enhancement mode Power MOSFET, designed with high density cell, with fast switching speed, low on-resistance, excellent thermal and electrical capabilities and operation with low gate voltages.

This device is suitable for use as a load switch or in PWM applications.

SYMBOL

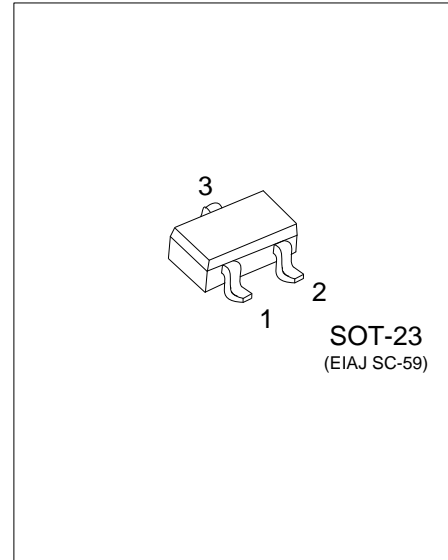
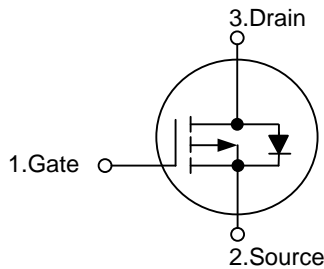

ORDERING INFORMATION

Ordering Number		Package	Pin Assignment			Packing
Lead Free	Halogen Free		1	2	3	
UT3401L-AE3-R	UT3401G-AE3-R	SOT-23	G	S	D	Tape Reel

Note: Pin Assignment: G: Gate S: Source D: Drain

	<p>(1) Packing Type</p> <p>(2) Package Type</p> <p>(3) Green Package</p>	<p>(1) R: Tape Reel</p> <p>(2) AE3: SOT-23</p> <p>(3) G: Halogen Free and Lead Free, L: Lead Free</p>
--	--	---

MARKING

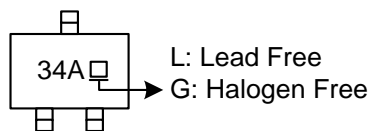

■ ABSOLUTE MAXIMUM RATINGS (T_A=25°C, unless otherwise specified)

PARAMETER	SYMBOL	RATINGS	UNIT
Drain-Source Voltage	V _{DSS}	-30	V
Gate-Source Voltage	V _{GSS}	±12	V
Continuous Drain Current (Note 1)	I _D	-4.2	A
Pulsed Drain Current (Note 2)	I _{DM}	-30	A
Power Dissipation (Note 1)	P _D	1.25	W
Junction Temperature	T _J	+150	°C
Storage Temperature	T _{STG}	-55 ~ +150	°C

Note: Absolute maximum ratings are those values beyond which the device could be permanently damaged. Absolute maximum ratings are stress ratings only and functional device operation is not implied.

■ THERMAL DATA

PARAMETER	SYMBOL	RATINGS	UNIT
Junction-to-Ambient	θ _{JA}	100	°C/W

Notes: Surface mounted on 1 in² copper pad of FR4 board with 2oz. Copper, in a still air environment with T_A=25°C.

■ ELECTRICAL CHARACTERISTICS (T_A=25°C, unless otherwise specified)

PARAMETER	SYMBOL	TEST CONDITIONS	MIN	TYP	MAX	UNIT
OFF CHARACTERISTICS						
Drain-Source Breakdown Voltage	BV _{DSS}	I _D =-250μA, V _{GS} =0V	-30			V
Drain-Source Leakage Current	I _{DSS}	V _{DS} =-24V, V _{GS} =0V			-1	μA
Gate-Source Leakage Current	I _{GSS}	V _{DS} =0V, V _{GS} =±12V			±100	nA
ON CHARACTERISTICS						
Gate Threshold Voltage	V _{GS(TH)}	V _{DS} =V _{GS} , I _D =-250μA	-0.7	-1	-1.3	V
Drain-Source On-State Resistance (Note 2)	R _{DS(ON)}	V _{GS} =-10V, I _D =-4.2A		42	50	mΩ
		V _{GS} =-4.5V, I _D =-4A		53	65	mΩ
		V _{GS} =-2.5V, I _D =-1A		80	120	mΩ
DYNAMIC PARAMETERS						
Input Capacitance	C _{ISS}	V _{GS} =0V, V _{DS} =-15V, f=1MHz		875		pF
Output Capacitance	C _{OSS}			125		pF
Reverse Transfer Capacitance	C _{RSS}			100		pF
SWITCHING PARAMETERS						
Total Gate Charge (Note 2)	Q _G	V _{GS} =-4.5V, V _{DS} =-15V, I _D =-4A		10.6		nC
Gate-Source Charge	Q _{GS}			2		nC
Gate-Drain Charge	Q _{GD}			2.5		nC
Turn-ON Delay Time (Note 2)	t _{D(ON)}	V _{GS} =-10V, V _{DS} =-15V R _L =3.6Ω, R _G =6Ω		1.6		ns
Turn-ON Rise Time	t _R			16		ns
Turn-OFF Delay Time	t _{D(OFF)}			38		ns
Turn-OFF Fall Time	t _F			24		ns
SOURCE- DRAIN DIODE RATINGS AND CHARACTERISTICS						
Maximum Continuous Drain-Source Diode Forward Current	I _S				-2.2	A
Drain-Source Diode Forward Voltage (Note2)	V _{SD}	V _{DS} =0V, I _S =-1A		-0.75	-1	V
Reverse Recovery Time	t _{rr}	I _F =-4A, dI/dt=100A/μs		20.2		ns
Reverse Recovery Charge	Q _{rr}				11.2	

Notes: 1. Repetitive Rating : Pulse width limited by maximum junction temperature.

2. Pulse width ≤300μs, duty cycle ≤2%.

3. Surface mounted on 1 in² copper pad of FR4 board with 2oz. Copper, in a still air environment with T_A=25°C.

TYPICAL CHARACTERISTICS

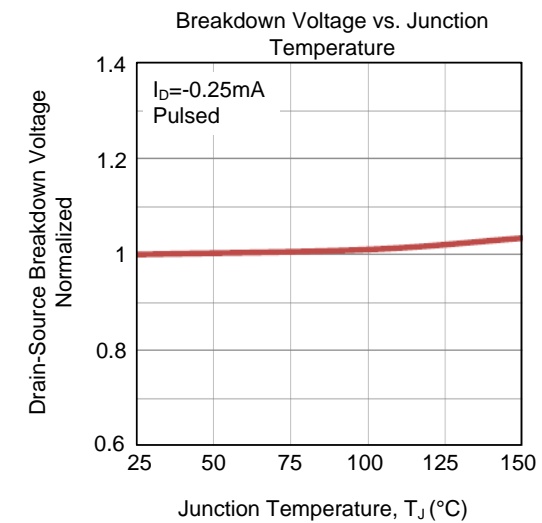
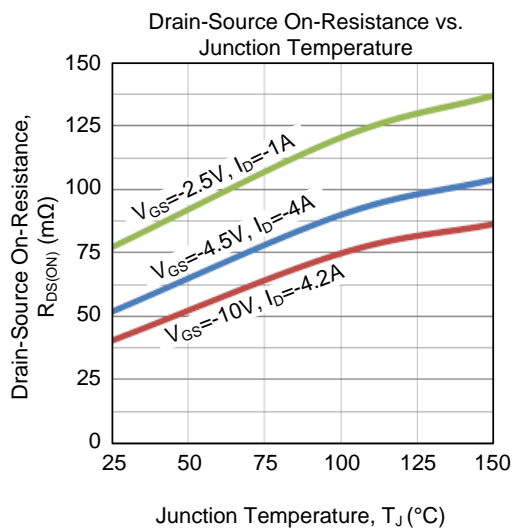
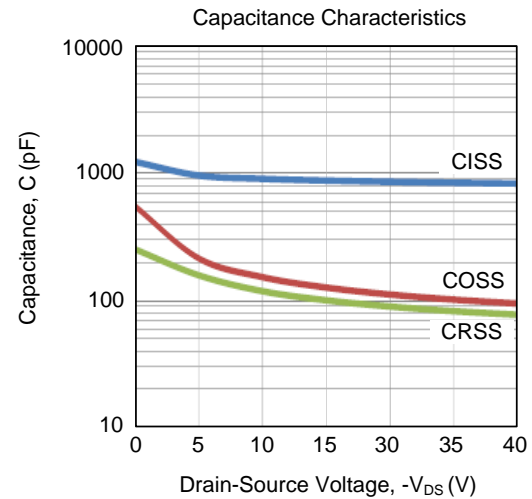
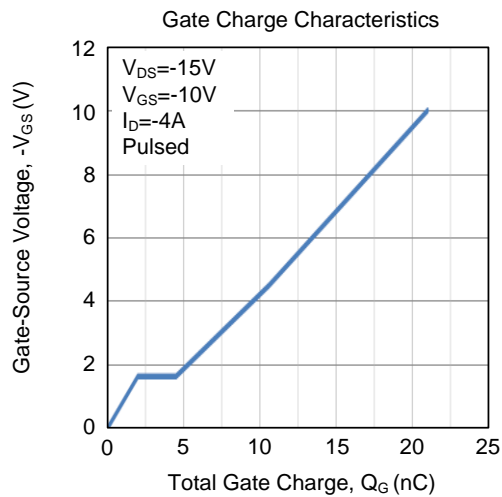
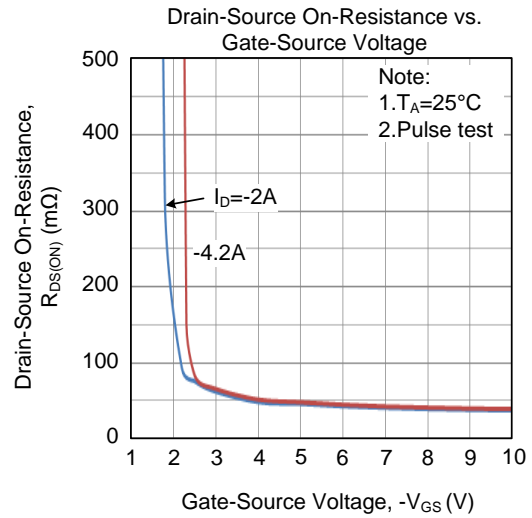
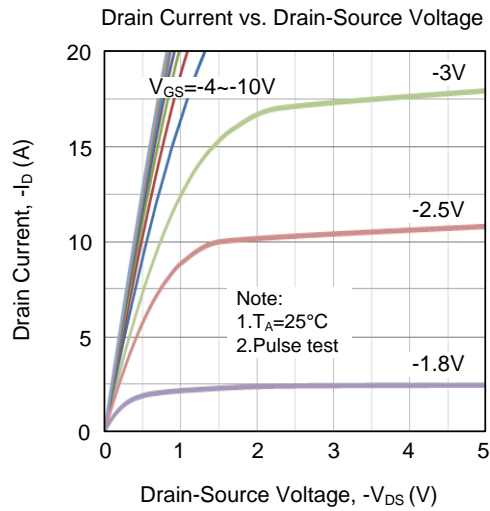

■ TYPICAL CHARACTERISTICS (Cont.)

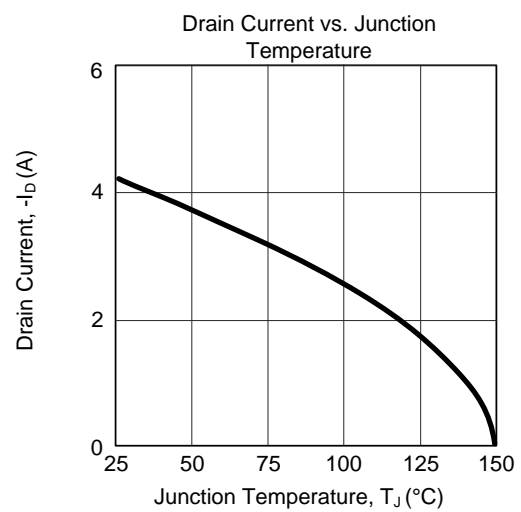
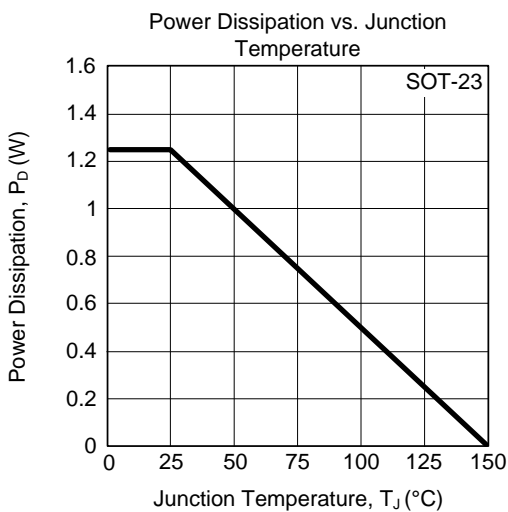
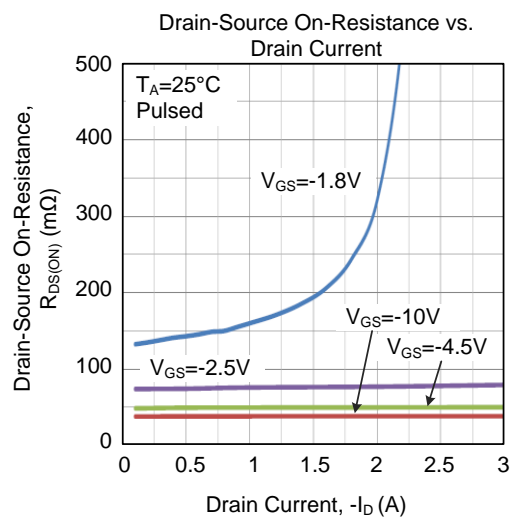
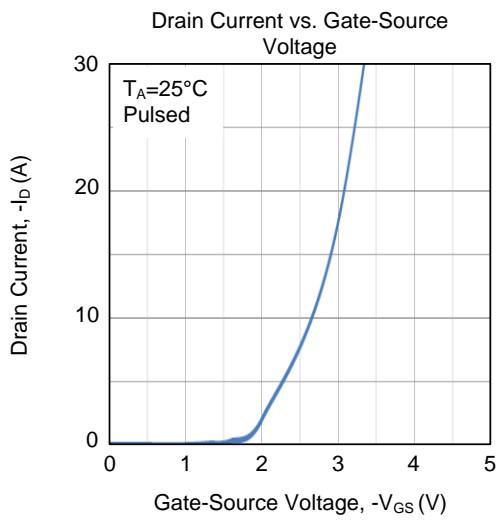
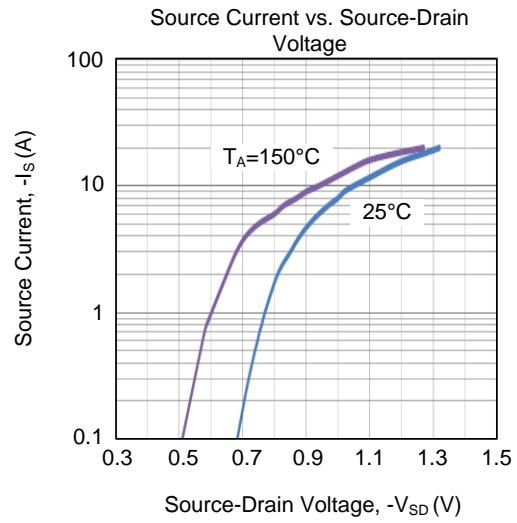
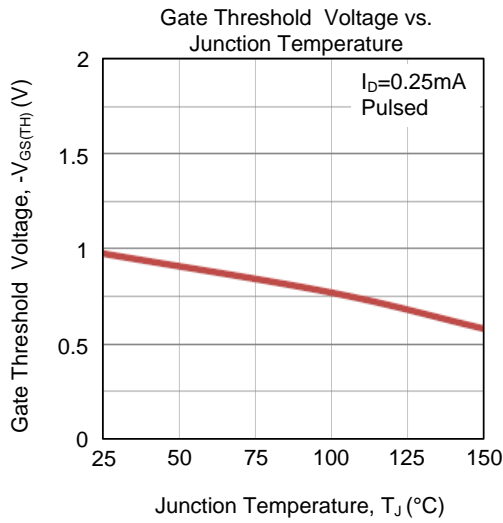

■ **TYPICAL CHARACTERISTICS (Cont.)**

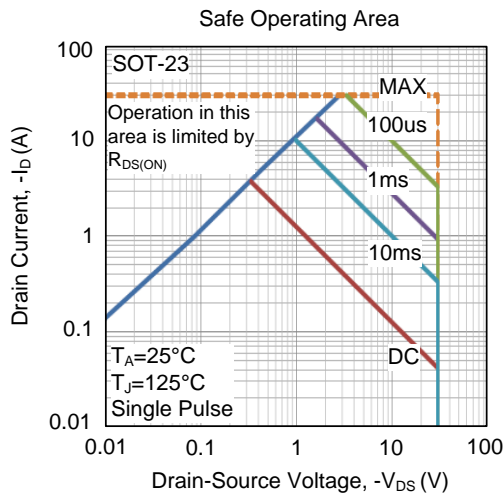

UTC assumes no responsibility for equipment failures that result from using products at values that exceed, even momentarily, rated values (such as maximum ratings, operating condition ranges, or other parameters) listed in products specifications of any and all UTC products described or contained herein. UTC products are not designed for use in life support appliances, devices or systems where malfunction of these products can be reasonably expected to result in personal injury. Reproduction in whole or in part is prohibited without the prior written consent of the copyright owner. UTC reserves the right to make changes to information published in this document, including without limitation specifications and product descriptions, at any time and without notice. This document supersedes and replaces all information supplied prior to the publication hereof.