



UTC654

Power MOSFET

P-CHANNEL ENHANCEMENT MODE POWER MOSFET

■ DESCRIPTION

As P-Channel Logic Level MOSFET, **UTC654** has been optimized for battery power management applications. And it's produced using UTC's advanced Power Trench process.

■ SYMBOL

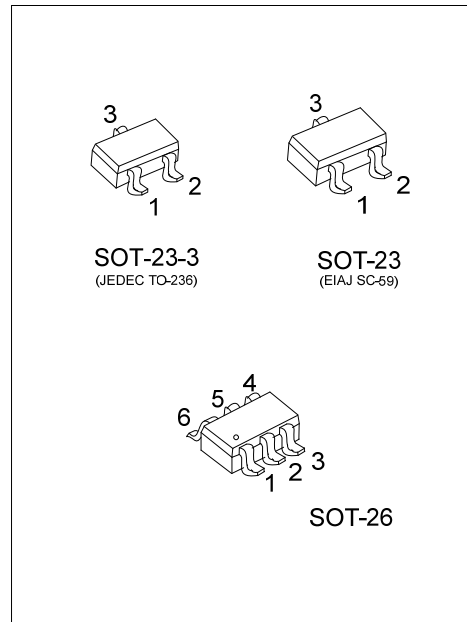
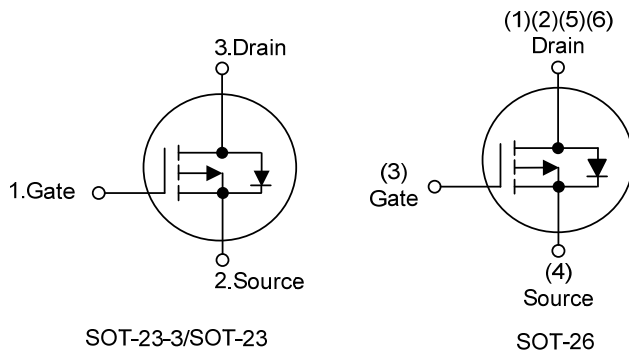

■ ORDERING INFORMATION

Ordering Number		Package	Pin Assignment						Packing
Lead Free	Halogen Free		1	2	3	4	5	6	
UTC654L-AE2-R	UTC654G-AE2-R	SOT-23-3	G	S	D	-	-	-	Tape Reel
UTC654L-AE3-R	UTC654G-AE3-R	SOT-23	G	S	D	-	-	-	Tape Reel
UTC654L-AG6-R	UTC654G-AG6-R	SOT-26	D	D	G	S	D	D	Tape Reel

Note: Pin Assignment: G: Gate S: Source D: Drain

<p>UTC654G-AE2-R</p> <ul style="list-style-type: none"> (1) Packing Type (2) Package Type (3) Green Package 	<ul style="list-style-type: none"> (1) R: Tape Reel (2) AE2: UTC654G-AE2-R, AE3: SOT-23, AG6: SOT-26 (3) G: Halogen Free and Lead Free, L: Lead Free
--	---

■ MARKING

SOT-23-3 / SOT-23	SOT-26
<p>L: Lead Free G: Halogen Free</p>	<p>L: Lead Free G: Halogen Free</p>

■ ABSOLUTE MAXIMUM RATINGS ($T_A = 25^\circ\text{C}$, unless otherwise specified)

PARAMETER		SYMBOL	RATINGS	UNIT
Drain-Source Voltage		V_{DSS}	-30	V
Gate-Source Voltage		V_{GSS}	± 20	
Continuous Drain Current (Note 3)		I_D	-3.6	A
Pulsed Drain Current (Note 2)		I_{DM}	-10	
Power Dissipation	SOT-23-3	P_D	1.1	W
	SOT-23		1.38	W
	SOT-26		1.6	W
Junction Temperature		T_J	+150	$^\circ\text{C}$
Storage Temperature		T_{STG}	-55 ~ +150	$^\circ\text{C}$

Note: Absolute maximum ratings are those values beyond which the device could be permanently damaged. Absolute maximum ratings are stress ratings only and functional device operation is not implied.

■ THERMAL DATA

PARAMETER		SYMBOL	RATINGS	UNIT
Junction to Ambient	SOT-23-3	θ_{JA}	113	$^\circ\text{C/W}$
	SOT-23		90	$^\circ\text{C/W}$
	SOT-26		78	$^\circ\text{C/W}$
Junction to Case	SOT-23-3	θ_{JC}	37	$^\circ\text{C/W}$
	SOT-23		32	$^\circ\text{C/W}$
	SOT-26		30	$^\circ\text{C/W}$

Note: Surface mounted on 1 in² copper pad of FR4 board; 270 $^\circ\text{C/W}$ when mounted on min.

■ ELECTRICAL CHARACTERISTICS ($T_A = 25^\circ\text{C}$, unless otherwise specified)

PARAMETER	SYMBOL	TEST CONDITIONS	MIN	TYP	MAX	UNIT
OFF CHARACTERISTICS						
Drain-Source Breakdown Voltage	BV_{DSS}	$V_{GS}=0\text{V}, I_D=-250\mu\text{A}$	-30			V
Drain-Source Leakage Current	I_{DSS}	$V_{DS}=-24\text{V}, V_{GS}=0\text{V}$			-1	μA
Gate-Source Leakage Current	I_{GSS}	$V_{DS}=0\text{V}, V_G=\pm 20\text{V}$			± 100	nA
ON CHARACTERISTICS						
Gate-Threshold Voltage	$V_{GS(TH)}$	$V_{DS}=V_{GS}, I_D=-250\mu\text{A}$	-1.0		-3.0	V
Static Drain-Source On-Resistance (Note 2)	$R_{DS(ON)}$	$V_{GS}=-10\text{V}, I_D=-3.6\text{A}$			75	m Ω
		$V_{GS}=-4.5\text{V}, I_D=-2.7\text{A}$			125	
DYNAMIC CHARACTERISTICS						
Input Capacitance	C_{ISS}	$V_{DS}=-15\text{V}, V_{GS}=0\text{V}, f=1.0\text{MHz}$		655		pF
Output Capacitance	C_{OSS}			124		
Reverse Transfer Capacitance	C_{RSS}			104		
SWITCHING CHARACTERISTICS						
Total Gate Charge (Note 2)	Q_G	$V_{DS}=-15\text{V}, V_{GS}=-10\text{V}, I_D=-3.6\text{A}, I_G=1\text{mA}$		14.4		nC
Gate-Source Charge	Q_{GS}			3.4		
Gate-Drain Charge	Q_{GD}			2.4		
Turn-ON Delay Time (Note 2)	$t_{D(ON)}$	$V_{DD}=-15\text{V}, I_D=-3.6\text{A}, V_{GS}=-10\text{V}, R_G=3.3\Omega$		4.2		ns
Turn-ON Rise Time	t_R			15.6		
Turn-OFF Delay Time	$t_{D(OFF)}$			18.4		
Turn-OFF Fall-Time	t_F			16.8		
SOURCE- DRAIN DIODE RATINGS AND CHARACTERISTICS						
Maximum Continuous Drain Source Diode Forward Current	I_S				-3.6	A
Maximum Body-Diode Pulsed Current	I_{SM}				-10	A
Drain-Source Diode Forward Voltage	V_{SD}	$V_{GS}=0\text{V}, I_S=-1.3\text{A}$ (Note 2)			-1.2	V

Notes: 1. Repetitive Rating: Pulse width limited by maximum junction temperature.
2. Pulse width $\leq 300\mu\text{s}$, duty cycle $\leq 2\%$.

TYPICAL CHARACTERISTICS

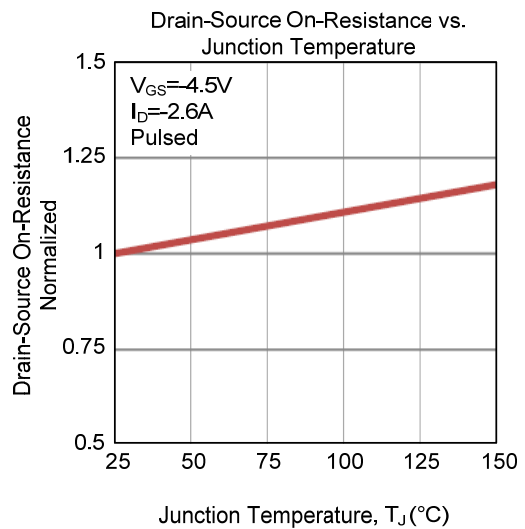
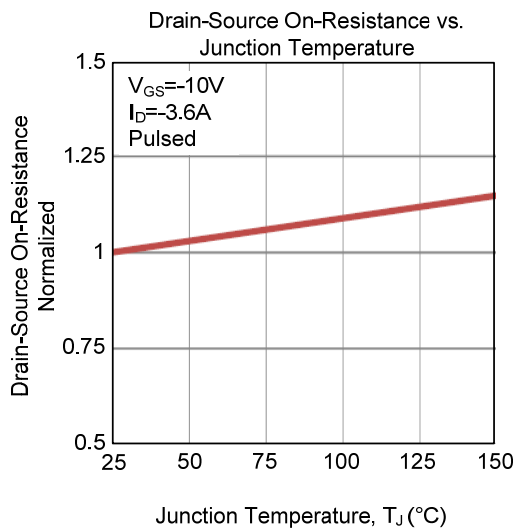
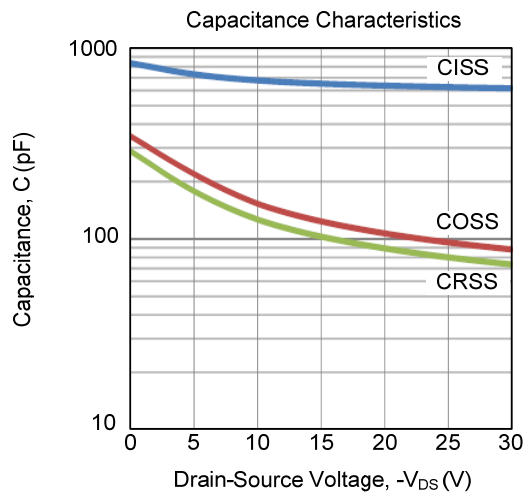
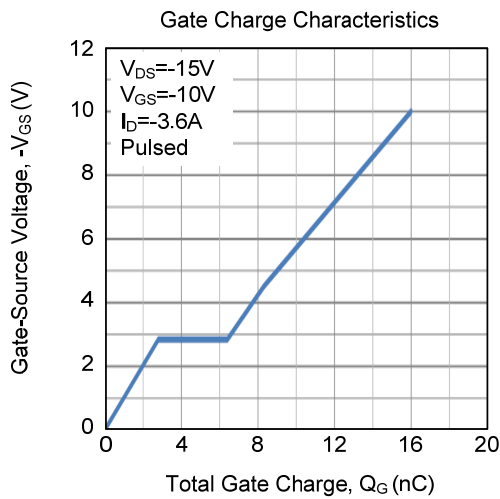
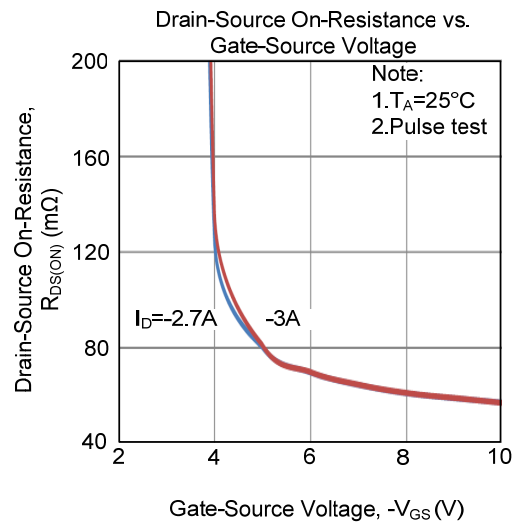
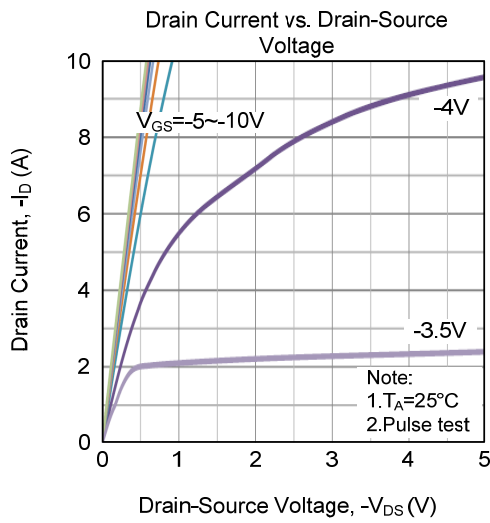

■ TYPICAL CHARACTERISTICS (Cont.)

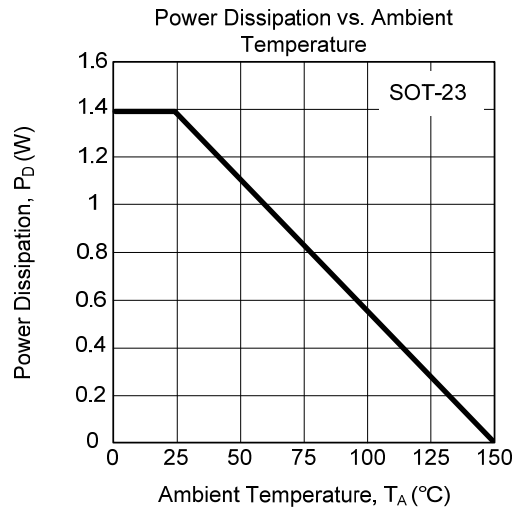
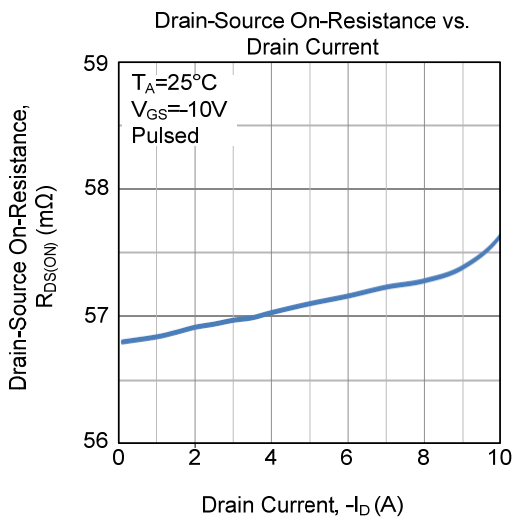
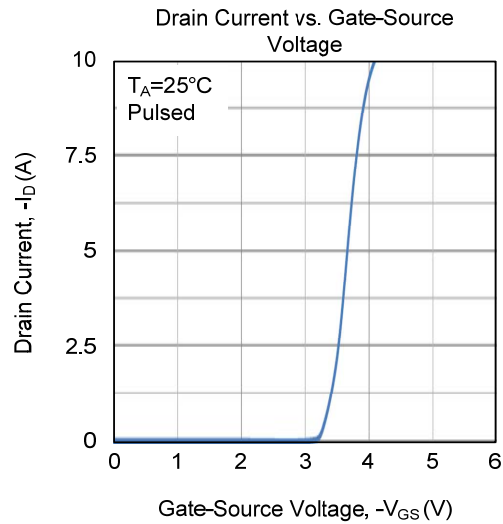
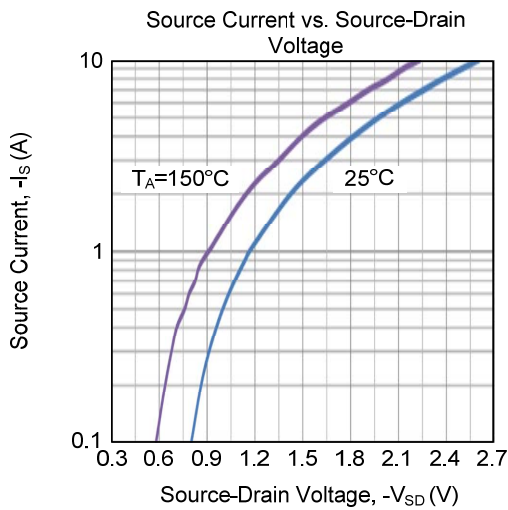
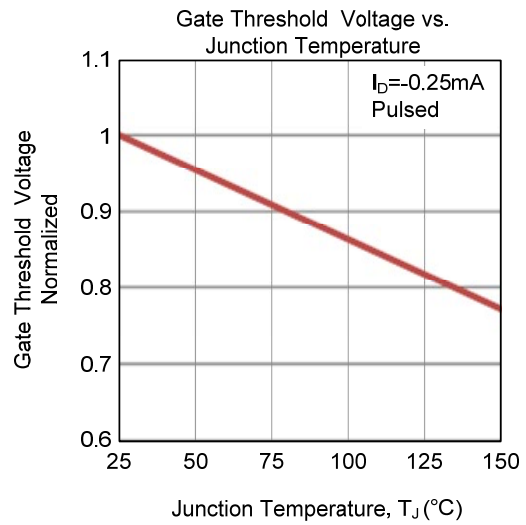
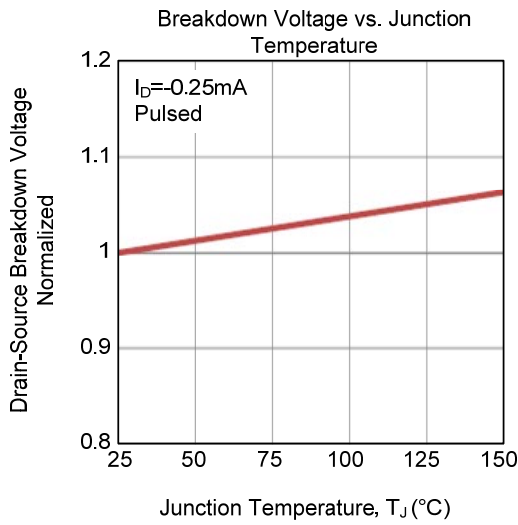

TYPICAL CHARACTERISTICS (Cont.)

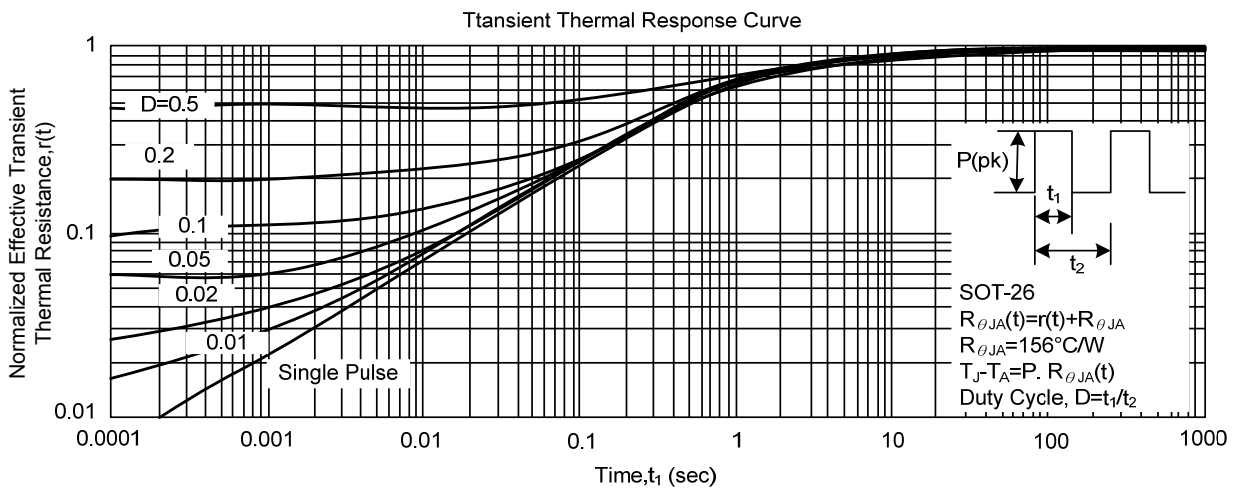
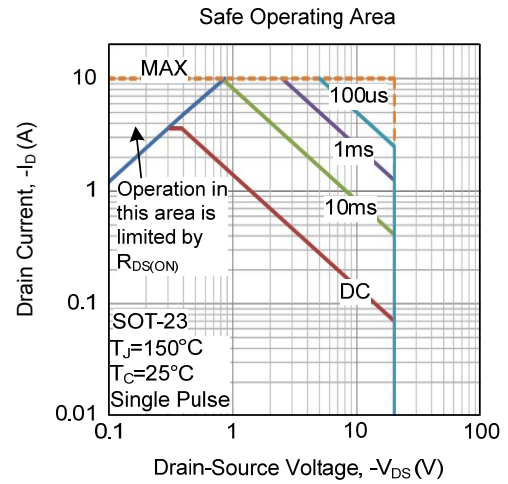
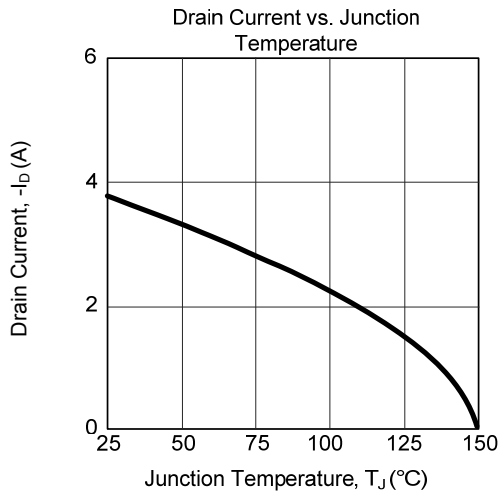

UTC assumes no responsibility for equipment failures that result from using products at values that exceed, even momentarily, rated values (such as maximum ratings, operating condition ranges, or other parameters) listed in products specifications of any and all UTC products described or contained herein. UTC products are not designed for use in life support appliances, devices or systems where malfunction of these products can be reasonably expected to result in personal injury. Reproduction in whole or in part is prohibited without the prior written consent of the copyright owner. UTC reserves the right to make changes to information published in this document, including without limitation specifications and product descriptions, at any time and without notice. This document supersedes and replaces all information supplied prior to the publication hereof.