



UTRS3082

Preliminary

CMOS IC

FAIL-SAFE, 115KBPS, RS-485 / RS-422 TRANSCEIVERS WITH $\pm 12KV$ ESD-PROTECTED

DESCRIPTION

The UTC **UTRS3082** is a half-duplex transceiver designed for RS-485 data bus network, which contains one transmitter and one receiver. The UTC **UTRS3082** features a fail-safe receiver, which guarantees the receiver to output high when the receiver inputs are open, short or idle.

The UTC **UTRS3082** also features a hot-swap glitch free protection circuits which guarantee outputs of both the transmitter and the receiver in a high impedance state during the power up period. So that the large short current from power to ground will be disabled by glitch free function, which will save the power and enhance the efficiency of the power up.

The UTC **UTRS3082** is optimized for signal rates up to 115Kbps with differential voltage of 2.3V. The UTC **UTRS3082** also has the thermal shutdown function when the temperature is over 150°C and the protection of the current limitation in the transmitter to protect the itself from the damage by the system-fault conditions during normal operation.

FEATURES

- * Meet the requirements of the EIA/TIA-485 standards.
- * 5.0V single power supply.
- * 1 μ A low-current shutdown mode.
- * HBM $\pm 12kV$ ESD protection.
- * True fail-safe receiver while maintaining EIA/TIA-485 compatibility.
- * Hot-swap glitch free protection on control inputs.
- * Up to 256 transceivers on the bus.
- * Maximum baud rate up to 115Kbps.
- * Transmitter short circuit current limit.
- * Thermal shutdown for overload protection.

ORDERING INFORMATION

Ordering Number		Package	Packing
Lead Free	Halogen Free		
UTRS3082L-S08-R	UTRS3082G-S08-R	SOP-8	Tape Reel

<p>UTRS3082G-S08-R</p> <p>(1)Packing Type</p> <p>(2)Package Type</p> <p>(3)Green Package</p>	<p>(1) R: Tape Reel</p> <p>(2) S08: SOP-8</p> <p>(3) G: Halogen Free and Lead Free, L: Lead Free</p>
----------------------------------------------------------------------------------------------	------------------------------------------------------------------------------------------------------

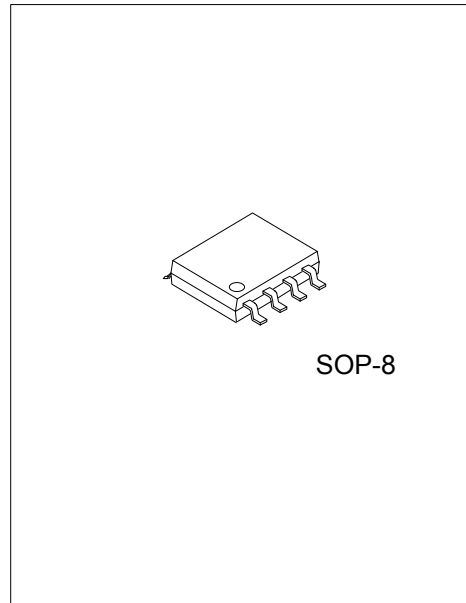

MARKING

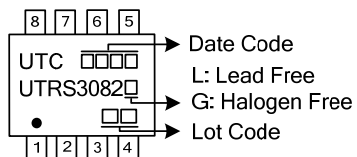

PIN CONFIGURATION

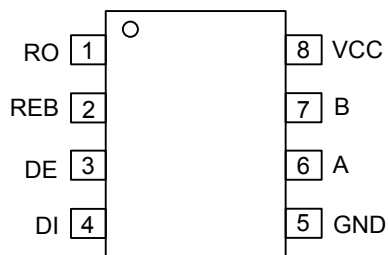

PIN DESCRIPTION

PIN NO.	PIN NAME	DESCRIPTION
1	RO	Receiver output.
2	REB	Receiver output enable: REB is low to enable the Receiver; REB is high to disable the Receiver.
3	DE	Transmitter output enable: DE is high to enable the transmitter; DE is low to disable the transmitter.
4	DI	Transmitter input: When DE is high, a low on DI forces An output low and B output high. Similarly, a high on DI forces An output high and B output low.
5	GND	Ground pin. Must be connected to 0V.
6	A	Non-inverting receiver input and non-inverting transmitter output
7	B	Inverting receiver input and inverting transmitter output
8	VCC	Power supply input 5.0V.

■ BLOCK DIAGRAM

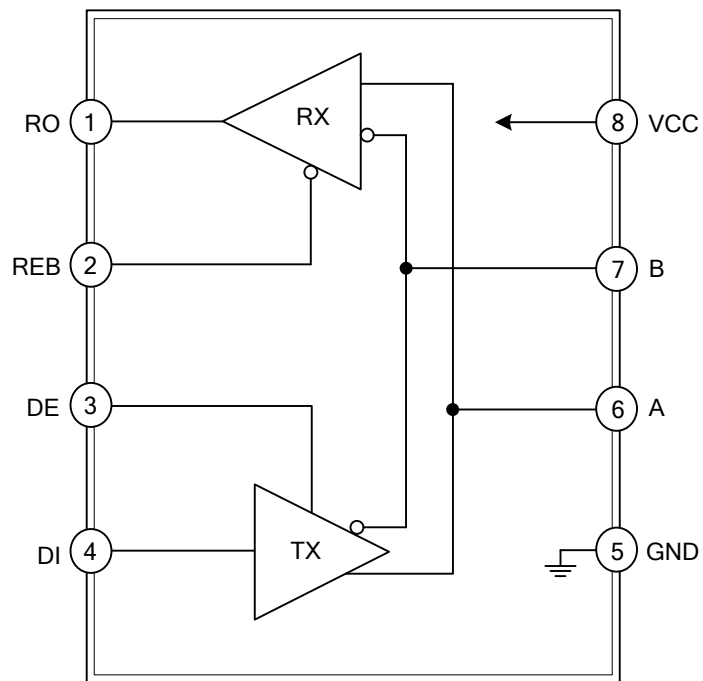

■ ABSOLUTE MAXIMUM RATING

PARAMETER	SYMBOL	RATINGS	UNIT
Power Supply V_{CC}	V_{CC}	-0.3 ~ 7.0	V
Control Input Voltage	REB, DE	-0.3 ~ ($V_{CC}+0.3$)	V
Receiver Input Voltage	A, B	± 12.5	V
Receiver Output Voltage	RO	-0.3 ~ ($V_{CC}+0.3$)	V
Transmitter Output Voltage	A, B	± 12.5	V
Transmitter Input	DI	-0.3 ~ ($V_{CC}+0.3$)	V
Operating Temperature	T_{OP}	-40 ~ +85	°C
Storage Temperature	T_{STG}	-65 ~ +150	°C

Note: Absolute maximum ratings are those values beyond which the device could be permanently damaged. Absolute maximum ratings are stress ratings only and functional device operation is not implied.

■ DC ELECTRICAL CHARACTERISTICS

($V_{CC}=5.0V \pm 5\%$ with $T_{AMB}=T_{MIN}$ to T_{MAX} , unless otherwise noted. Typical values are at $V_{CC}=5.0V$ and $T_A=25^\circ C$.)

PARAMETER	SYMBOL	TEST CONDITIONS	MIN	TYP	MAX	UNIT
TRANSMITTER						
Differential Transmitter Output	V_{OD1}	No Load			5.0	V
Differential Transmitter Output	V_{OD2}	Fig.1, $R_L=27\Omega$	1.5			V
Change in Magnitude of Differential Output Voltage	ΔV_{OD}	Fig.1, $R_L=27\Omega$			0.2	V
Transmitter Common- Mode Output Voltage	V_{OC}	Fig.1, $R_L=27\Omega$			3.0	V
Change in Magnitude of Common- Mode Voltage	ΔV_{OC}	Fig.1, $R_L=27\Omega$			0.2	V
Input High Voltage	V_{IH}	DE, DI, REB	2.0			V
Input Low Voltage	V_{IL}	DE, DI, REB			0.8	V
Input Current	I_{IN1}	DI			± 1.0	μA
Input Current	I_{IN2}	DE, REB			± 50	μA
DI Input Hysteresis	V_{HYS}			100		mV
Input Current (A and B)	I_{IN3}	DE=GND, $V_{CC}=GND$ or 5.25V	$V_{IN}=12V$ $V_{IN}=-7V$		125 -75	μA μA
Transmitter Short-Circuit Output Current	I_{OS}	$-7V \leq V_{OUT} \leq V_{CC}$ $0V \leq V_{OUT} \leq 12V$	-250		250	mA mA
RECEIVER						
Receiver Differential Threshold Voltage	V_{TH}	$V_{CM}=+2.5V$	-200		-20	mV
Receiver Input Hysteresis	ΔV_{TH}			25		mV
Receiver Output High Voltage	V_{OH}	$I_O=-4mA$, $V_{ID}=-20mV$	$V_{CC}-1.5$			V
Receiver Output Low Voltage	V_{OL}	$I_O=4mA$, $V_{ID}=-200mV$			0.5	V
Three- State Output Current at Receiver	I_{OZR}	$0.4V \leq V_{CM} \leq 2.4V$			± 1.0	μA
Receiver Input Resistance	R_{IN}	$-7V \leq V_{CM} \leq +12V$	96			k Ω
Receiver Output Short-Circuit Current	I_{OSR}	Fig.6 , $0V \leq V_{RO} \leq V_{CC}$	± 7		± 95	mA
SUPPLY CURRENT						
Supply Current	I_{CC}	No Load, REB=GND, DI=VCC or GND.	DE= V_{CC} DE=GND		420 320	900 600 μA μA
Supply Current in Shutdown Mode	I_{SHDN}	REB= V_{CC} , DE=GND		1.0	10	μA

■ SWITCHING CHARACTERISTICS

($V_{CC}=5.0V \pm 5\%$ with $T_A = T_{MIN}$ to T_{MAX} , unless otherwise noted. Typical values are at $V_{CC}=5.0V$ and $T_{AMB}=25^\circ C$.)

PARAMETER	SYMBOL	TEST CONDITIONS	MIN	TYP	MAX	UNIT
Transmitter Input to Output	t_{DPLH}, t_{DPHL}	Fig.2 and 7, $R_{DIFF}=54\Omega, C_{L1}=C_{L2}=100pF$		980	2600	ns
Transmitter Output Skew $ t_{DPLH} - t_{DPHL} $	t_{DSKEW}	Fig.2 and 7, $R_{DIFF}=54\Omega, C_{L1}=C_{L2}=100pF$		10		ns
Transmitter Rise or Fall Time	t_{DF}, t_{DR}	Fig.2 and 7, $R_{DIFF}=54\Omega, C_{L1}=C_{L2}=100pF$		1500	2500	ns
Maximum Data Rate	f_{MAX}		115			Kbps
Transmitter Enable to Output Low	t_{DZL}	Fig.4 and 8, $C_{DL}=100pF, S1$ Closed			3500	ns
Transmitter Enable to Output High	t_{DZH}	Fig.4 and 8, $C_{DL}=100pF, S2$ Closed			3500	ns
Transmitter Disable Time from Low	t_{DLZ}	Fig.4 and 8, $C_{DL}=15pF, S1$ Closed			500	ns
Transmitter Disable Time from High	t_{DHZ}	Fig.4 and 8, $C_{DL}=15pF, S2$ Closed			500	ns
Receiver Input to Output	t_{RPLH}, t_{RPHL}	Fig.5 and 9, $ V_{ID} \geq 2.0V$; Rise and Fall Time of $V_{ID}\leq 15ns$		200		ns
$ t_{RPLH} - t_{RPHL} $ Different Receiver Skew	t_{RSKD}	Fig.5 and 9, $ V_{ID} \geq 2.0V$; Rise and Fall Time of $V_{ID}\leq 15ns$		100		ns
Receiver Enable to Output Low	t_{RZL}	Fig.3 and 10, $C_{RL}=100pF, S1$ Closed		50		ns
Receiver Enable to Output High	t_{RZH}	Fig.3 and 10, $C_{RL}=100pF, S2$ Closed		50		ns
Receiver Disable Time from Low	t_{RLZ}	Fig.3 and 10, $C_{RL}=100pF, S1$ Closed		50		ns
Receiver Disable Time from High	t_{RHZ}	Fig.3 and 10, $C_{RL}=100pF, S2$ Closed		50		ns
Time to Shutdown	t_{SHDN}			500		ns
Transmitter Enable from Shutdown to Output Low	$t_{DZL(SHDN)}$	Fig.4 and 8, $C_{DL}=15pF, S1$ Closed		500	5500	ns
Transmitter Enable from Shutdown to Output High	$t_{DZH(SHDN)}$	Fig.4 and 8, $C_{DL}=15pF, S2$ Closed		500	5500	ns
Receiver Enable from Shutdown to Output Low	$t_{RZL(SHDN)}$	Fig.3 and 10, $C_{RL}=100pF, S1$ Closed		1500	4500	ns
Receiver Enable from Shutdown to Output High	$t_{RZH(SHDN)}$	Fig.3 and 10, $C_{RL}=100pF, S2$ Closed		1500	4500	ns

■ FUNCTION TABLE

TRANSMITTING				
INPUTS			OUTPUTS	
REB	DE	DI	A	B
X	1	0	0	1
X	1	1	1	0
0	0	X	High-Z	High-Z
1	0	X	Shutdown	

RECEIVING			
INPUTS			OUTPUT
REB	DE	A-B	RO
0	X	$\geq -0.02V$	1
0	X	$\leq -0.2V$	0
0	X	Open/Shorted	1
1	1	X	High-Z
1	0	X	Shutdown

X = Don't care

Shutdown mode, transmitter and receiver outputs high impedance

■ TEST CIRCUIT

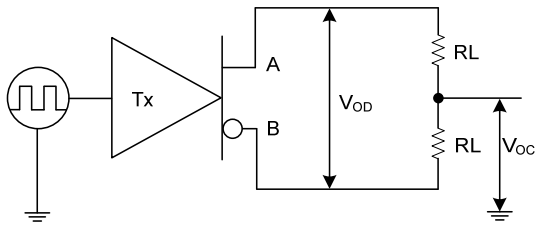

Fig. 1 Transmitter DC Test Circuit

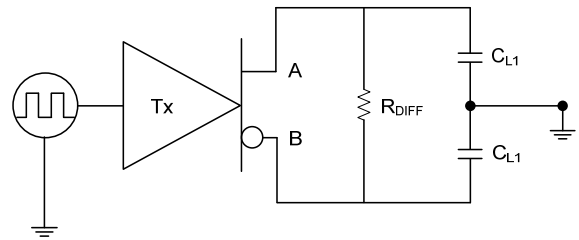

Fig. 2 Transmitter Timing Test Circuit

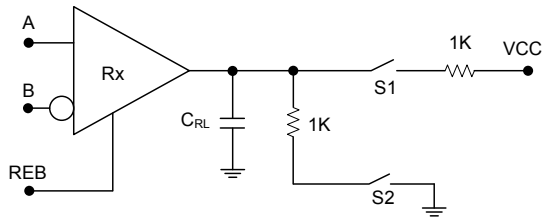

Fig. 3 Receiver Enable/Disable Timing Test Circuit

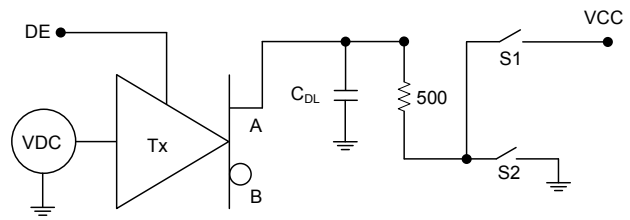

Fig. 4 Transmitter Enable/Disable Timing Test Circuit

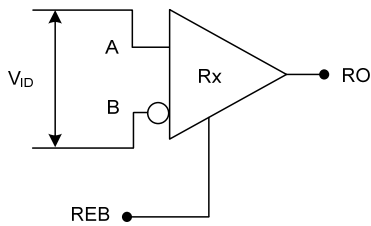

Fig. 5 Receiver Timing Test Circuit

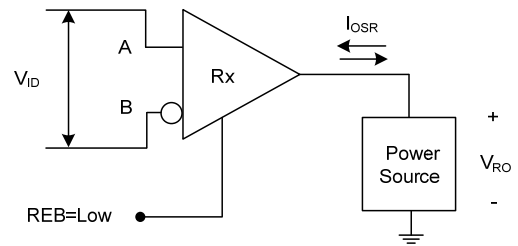

Fig. 6 Receiver Output Short Circuit

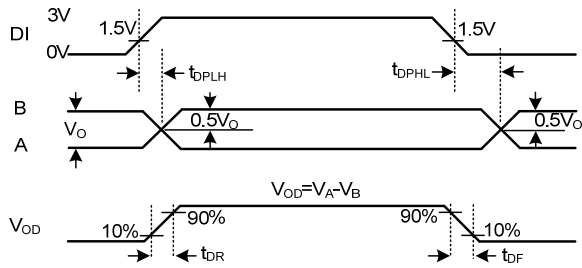

Fig. 7 Transmitter Propagation Delays

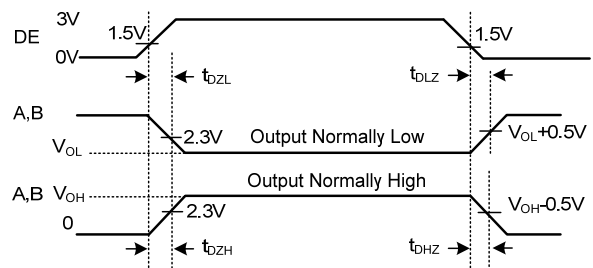

Fig. 8 Transmitter Enable and Disable Times

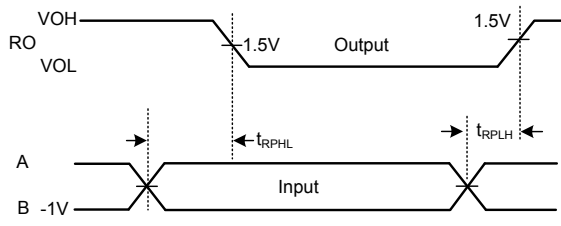

Fig. 9 Receiver Propagation Delays

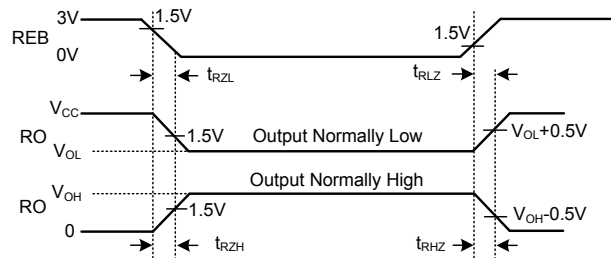

Fig. 10 Receiver Enable and Disable Times

UTC assumes no responsibility for equipment failures that result from using products at values that exceed, even momentarily, rated values (such as maximum ratings, operating condition ranges, or other parameters) listed in products specifications of any and all UTC products described or contained herein. UTC products are not designed for use in life support appliances, devices or systems where malfunction of these products can be reasonably expected to result in personal injury. Reproduction in whole or in part is prohibited without the prior written consent of the copyright owner. UTC reserves the right to make changes to information published in this document, including without limitation specifications and product descriptions, at any time and without notice. This document supersedes and replaces all information supplied prior to the publication hereof.