

SWITCH NPN TRANSISTOR

APPLICATION

*Humidifier,DC-DC converter,and general purpose.

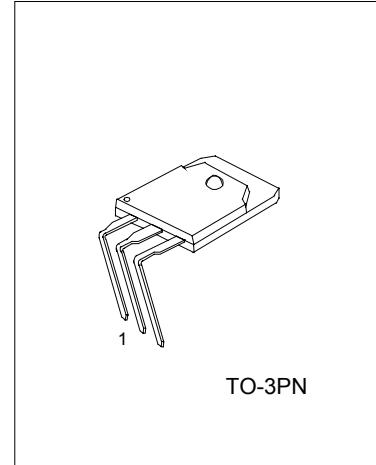

TO-3PN

1: BASE 2:COLLECTOR 3: EMITTER

ABSOLUTE MAXIMUM RATINGS (Ta=25°C)

PARAMETER	SYMBOL	RATING	UNIT
Collector-Base Voltage	V _{CB0}	200	V
Collector-Emitter Voltage	V _{CEO}	120	V
Emitter-Base Voltage	V _{EB0}	8	V
Base Current	I _B	3	A
Collector Current	I _C	7	A
Collector Current (PULSE)		14	A
Collector Power Dissipation(T _c =25°C)	P _c	70	W
Junction Temperature	T _j	150	°C
Storage Temperature	T _{STG}	-55 ~ +150	°C

ELECTRICAL CHARACTERISTICS (Ta=25°C,unless otherwise specified)

PARAMETER	SYMBOL	TEST CONDITIONS	MIN	TYP	MAX	UNIT
Collector Emitter Breakdown Voltage	BV _{CEO}	I _C = 50mA	120			V
Collector Cut-Off Current	I _{CBO}	V _{CB} =200V, I _E =0			100	μA
Emitter Cut-Off Current	I _{EB0}	V _{EB} = 8V, I _C =0			100	μA
DC Current Transfer Ratio	h _{FE}	V _{CE} = 4V, I _C = 3A	70		220	
Collector-Emitter Saturation Voltage	V _{CE(sat)}	I _C =3A ,I _B =0.3A			0.5	V
Base-Emitter Saturation Voltage	V _{BE(sat)}	I _C =3A ,I _B =0.3A			1.2	V
Transition Frequency	f _T	V _{CE} =12V, I _E =-0.5mA		30		MHz
Output Capacitance	C _{ob}	V _{CB} = 10V, I _E = 0 A, f=1MHz		110		pF
Turn-on Time	t _{on}	See specified Test Circuit			0.5	μs
Storage Time	t _{stg}				3.0	μs
Fall Time	t _f				0.5	μs

UTC2SC3835 NPN EPITAXIAL SILICON TRANSISTOR

CLASSIFICATION of hFE

RANK	A	B	C
RANGE	70-130	120-170	160-220

Typical Switching Characteristics(Common Emitter)

V _{CC} (V)	R _L (Ω)	I _C (A)	V _{BB1} (V)	V _{BB2} (V)	I _{B1} (A)	I _{B2} (A)
50	16.7	3	10	-5	0.3	-0.6

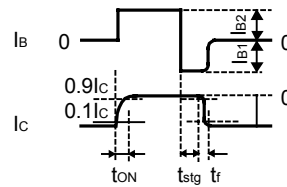
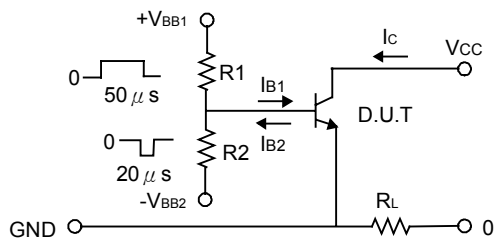

ELECTRICAL CHARACTERISTICS CURVES

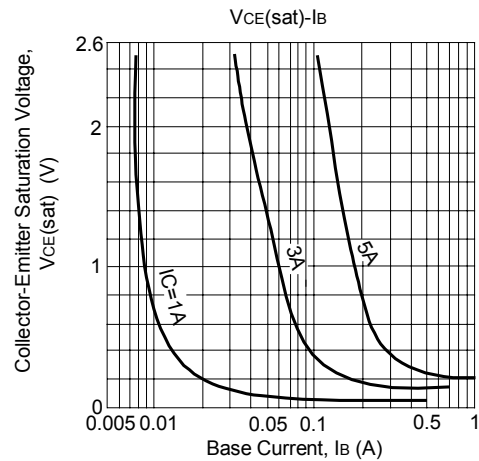
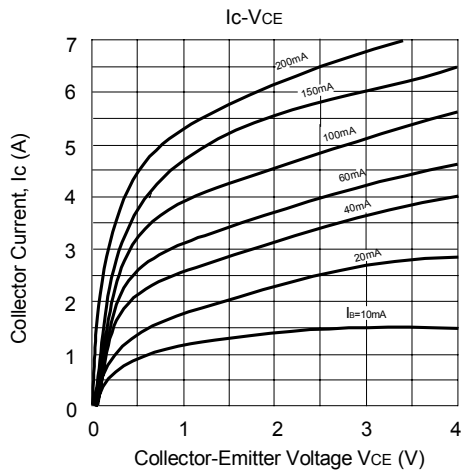

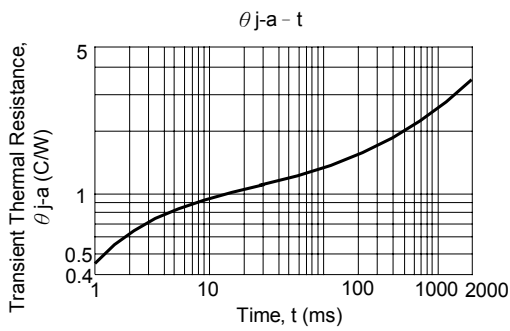
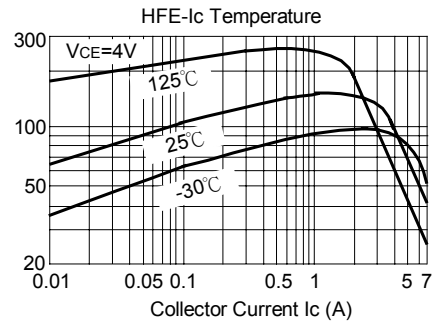
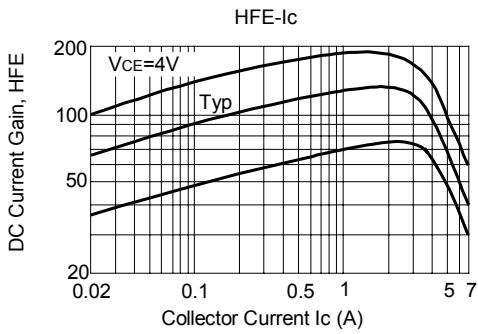
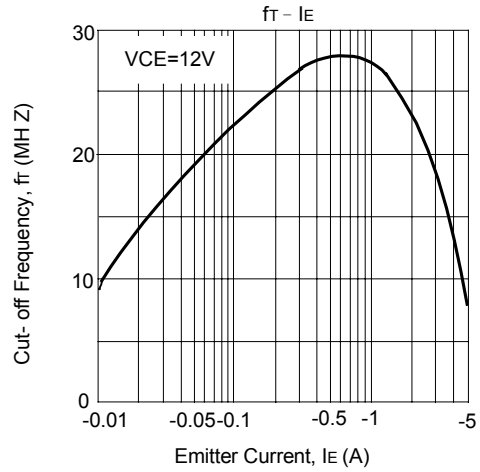
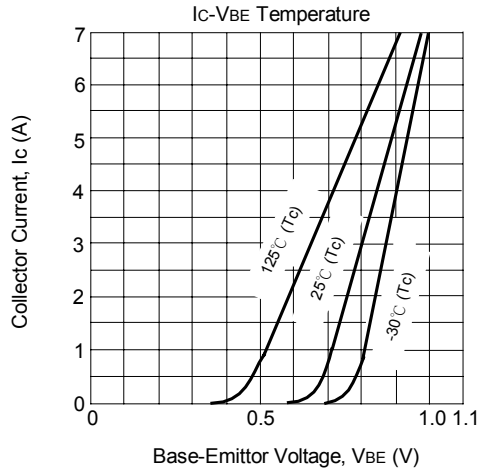

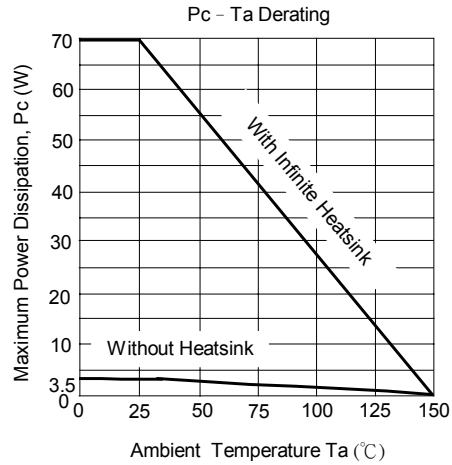
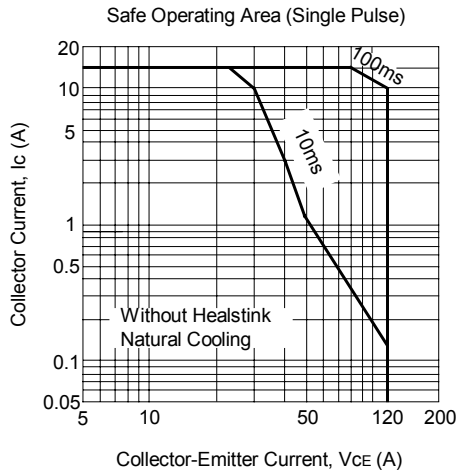

UTC assumes no responsibility for equipment failures that result from using products at values that exceed, even momentarily, rated values (such as maximum ratings, operating condition ranges, or other parameters) listed in products specifications of any and all UTC products described or contained herein. UTC products are not designed for use in life support appliances, devices or systems where malfunction of these products can be reasonably expected to result in personal injury. Reproduction in whole or in part is prohibited without the prior written consent of the copyright owner. The information presented in this document does not form part of any quotation or contract, is believed to be accurate and reliable and may be changed without notice.