

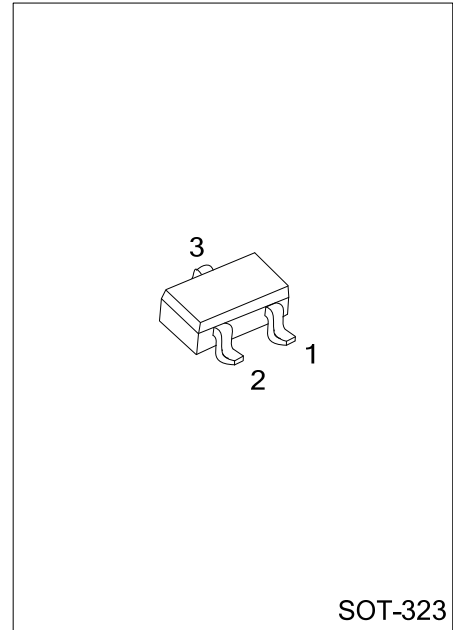

## 2SC4774

## NPN SILICON TRANSISTOR

### HIGH FREQUENCY AMPLIFIER TRANSISTOR, RF SWITCHING (6V, 50mA)



SOT-323

#### FEATURES

- \* Very low output-on resistance ( $R_{ON}$ ).
- \* Low capacitance.

#### ORDERING INFORMATION

Order Number		Package	Pin Assignment			Packing
Lead Free	Halogen Free		1	2	3	
2SC4774L-AL3-R	2SC4774G-AL3-R	SOT-323	E	B	C	Tape Reel

<p>2SC4774G-AL3-R</p> <p>(1) Packing Type (2) Package Type (3) Lead Plating</p>	<p>(1) R: Tape Reel (2) AL3: SOT-323 (3) G: Halogen Free, L: Lead Free</p>
---	--

#### MARKING

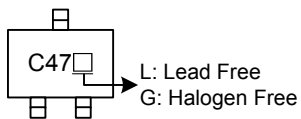

■ ABSOLUTE MAXIMUM RATINGS (Ta=25°C)

PARAMETER	SYMBOL	RATINGS	UNIT
Collector-Base Voltage	$V_{CBO}$	12	V
Collector-Emitter Voltage	$V_{CEO}$	6	V
Emitter-Base Voltage	$V_{EBO}$	3	V
Collector Current	$I_C$	50	mA
Collector Power Dissipation	$P_D$	0.2	W
Junction Temperature	$T_J$	+150	°C
Storage Temperature	$T_{STG}$	-40 ~ +150	°C

Note Absolute maximum ratings are those values beyond which the device could be permanently damaged.  
Absolute maximum ratings are stress ratings only and functional device operation is not implied.

■ ELECTRICAL SPECIFICATIONS (Ta=25°C)

PARAMETER	SYMBOL	TEST CONDITIONS	MIN	TYP	MAX	UNIT
Collector-Base Breakdown Voltage	$BV_{CBO}$	$I_C = 10\mu A$	12			V
Collector-Emitter Breakdown Voltage	$BV_{CEO}$	$I_C = 1mA$	6			V
Emitter-Base Breakdown Voltage	$BV_{EBO}$	$I_E = 10\mu A$	3			V
Collector Cutoff Current	$I_{CBO}$	$V_{CB} = 10V$			0.5	V
Emitter Cutoff Current	$I_{EBO}$	$V_{EB} = 2V$			0.5	$\mu A$
Collector-Emitter Saturation Voltage	$V_{CE(SAT)}$	$I_C/I_B = 10mA/1mA$			0.3	$\mu A$
DC Current Transfer Ratio	$h_{FE}$	$V_{CE}/I_C = 5V/5mA$	270		560	
Transition Frequency	$f_T$	$V_{CE} = 5V, I_E = -10mA, f = 200MHz$	300	800		MHz
Output Capacitance	$C_{ob}$	$V_{CB} = 10V, I_E = 0A, f = 1MHz$		1	1.7	pF
Output-On Resistance	$R_{ON}$	$I_B = 3mA, V_{IN} = 100mVrms, f = 500kHz$		2		$\Omega$

## TYPICAL CHARACTERISTIC

Grounded Emitter Output Characteristics ( I )

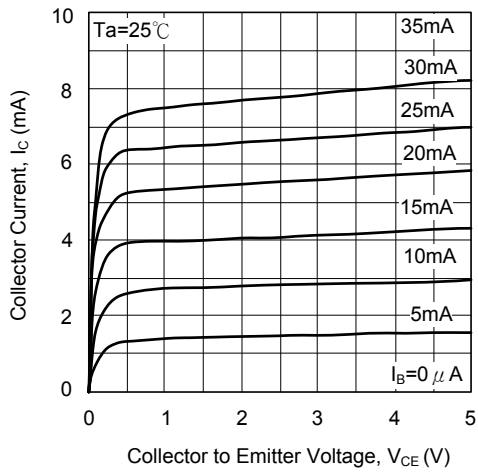

Grounded Emitter Output Characteristics ( II )

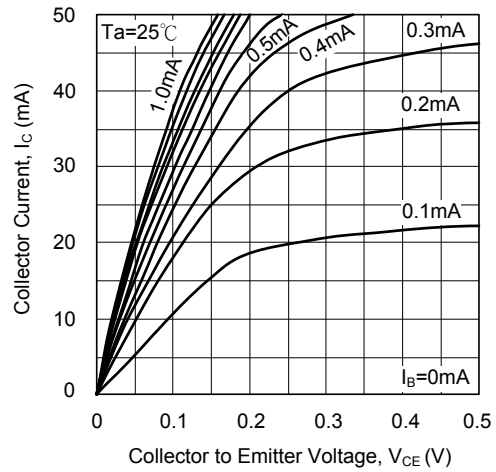

Grounded Emitter Propagation Characteristics

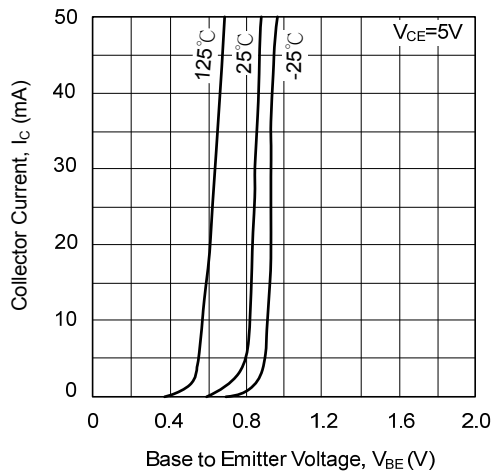

DC Current Gain vs. Collector Current

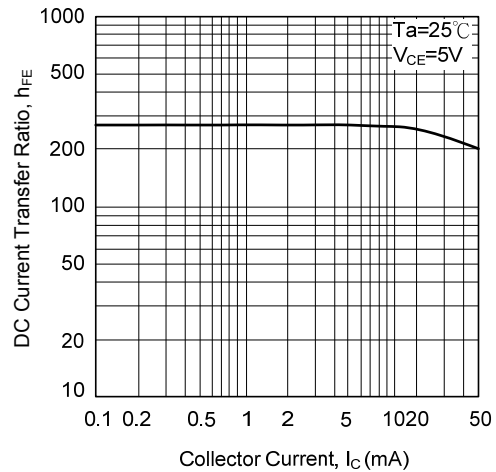

Collector-Emitter Saturation Voltage vs. Collector Current

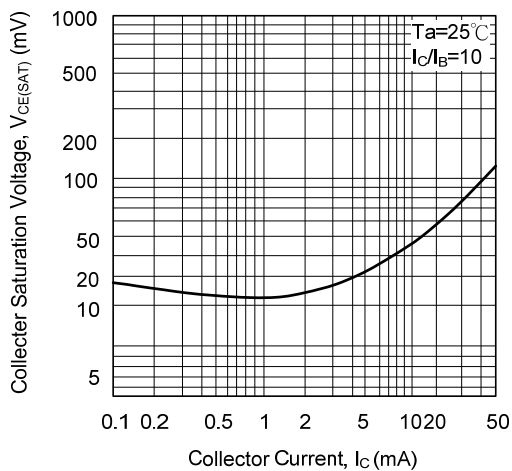

Gain Bandwidth Product vs. Collector Current

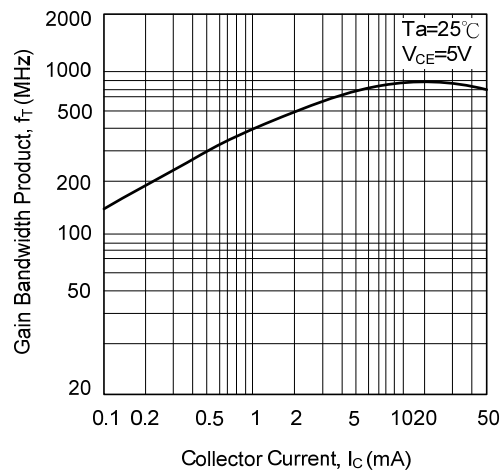

■ TYPICAL CHARACTERISTIC(Cont.)

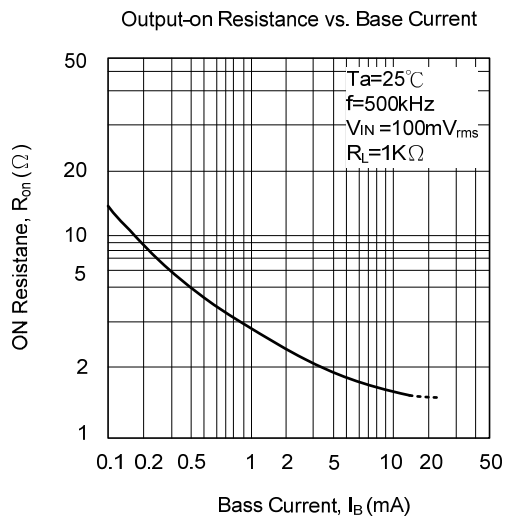
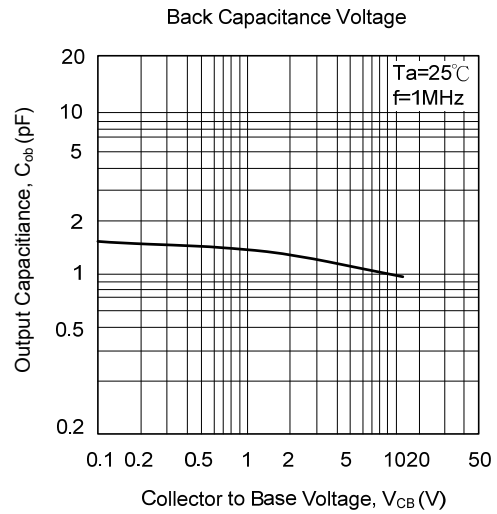
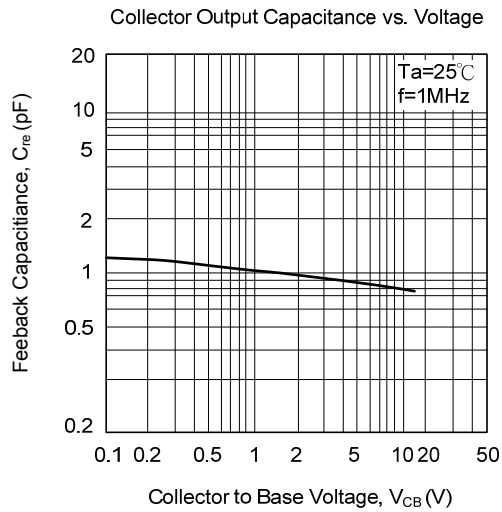

UTC assumes no responsibility for equipment failures that result from using products at values that exceed, even momentarily, rated values (such as maximum ratings, operating condition ranges, or other parameters) listed in products specifications of any and all UTC products described or contained herein. UTC products are not designed for use in life support appliances, devices or systems where malfunction of these products can be reasonably expected to result in personal injury. Reproduction in whole or in part is prohibited without the prior written consent of the copyright owner. The information presented in this document does not form part of any quotation or contract, is believed to be accurate and reliable and may be changed without notice.